

## **Digital Imaging and Communications in Medicine (DICOM)**

### **Part 2: Conformance**

*Published by*

**National Electrical Manufacturers Association**

1300 N. 17th Street

Rosslyn, Virginia 22209 USA

© Copyright 2008 by the National Electrical Manufacturers Association. All rights including translation into other languages, reserved under the Universal Copyright Convention, the Berne Convention for the Protection of Literacy and Artistic Works, and the International and Pan American Copyright Conventions.

## NOTICE AND DISCLAIMER

The information in this publication was considered technically sound by the consensus of persons engaged in the development and approval of the document at the time it was developed. Consensus does not necessarily mean that there is unanimous agreement among every person participating in the development of this document.

NEMA standards and guideline publications, of which the document contained herein is one, are developed through a voluntary consensus standards development process. This process brings together volunteers and/or seeks out the views of persons who have an interest in the topic covered by this publication. While NEMA administers the process and establishes rules to promote fairness in the development of consensus, it does not write the document and it does not independently test, evaluate, or verify the accuracy or completeness of any information or the soundness of any judgments contained in its standards and guideline publications.

NEMA disclaims liability for any personal injury, property, or other damages of any nature whatsoever, whether special, indirect, consequential, or compensatory, directly or indirectly resulting from the publication, use of, application, or reliance on this document. NEMA disclaims and makes no guaranty or warranty, expressed or implied, as to the accuracy or completeness of any information published herein, and disclaims and makes no warranty that the information in this document will fulfill any of your particular purposes or needs. NEMA does not undertake to guarantee the performance of any individual manufacturer or seller's products or services by virtue of this standard or guide.

In publishing and making this document available, NEMA is not undertaking to render professional or other services for or on behalf of any person or entity, nor is NEMA undertaking to perform any duty owed by any person or entity to someone else. Anyone using this document should rely on his or her own independent judgment or, as appropriate, seek the advice of a competent professional in determining the exercise of reasonable care in any given circumstances. Information and other standards on the topic covered by this publication may be available from other sources, which the user may wish to consult for additional views or information not covered by this publication.

NEMA has no power, nor does it undertake to police or enforce compliance with the contents of this document. NEMA does not certify, test, or inspect products, designs, or installations for safety or health purposes. Any certification or other statement of compliance with any health or safety-related information in this document shall not be attributable to NEMA and is solely the responsibility of the certifier or maker of the statement.

## CONTENTS

|                                                                        |    |
|------------------------------------------------------------------------|----|
| NOTICE AND DISCLAIMER .....                                            | 2  |
| CONTENTS .....                                                         | 3  |
| FOREWORD .....                                                         | 12 |
| 1 SCOPE AND FIELD OF APPLICATION .....                                 | 13 |
| 2 NORMATIVE REFERENCES .....                                           | 13 |
| 3 DEFINITIONS .....                                                    | 14 |
| 3.1 REFERENCE MODEL DEFINITIONS .....                                  | 14 |
| 3.2 ACSE SERVICE DEFINITIONS .....                                     | 14 |
| 3.3 PRESENTATION SERVICE DEFINITIONS .....                             | 14 |
| 3.4 DICOM INTRODUCTION AND OVERVIEW DEFINITIONS .....                  | 14 |
| 3.5 DICOM INFORMATION OBJECT DEFINITIONS .....                         | 14 |
| 3.6 DICOM SERVICE CLASS SPECIFICATION DEFINITIONS .....                | 14 |
| 3.7 DICOM DATA STRUCTURE AND ENCODING DEFINITIONS .....                | 15 |
| 3.8 DICOM MESSAGE EXCHANGE DEFINITIONS .....                           | 15 |
| 3.9 DICOM UPPER LAYER SERVICE DEFINITIONS .....                        | 15 |
| 3.10 MEDIA STORAGE AND FILE FORMAT FOR DATA INTERCHANGE .....          | 15 |
| 3.11 DICOM CONFORMANCE .....                                           | 15 |
| 3.11.1.. Conformance Statement .....                                   | 15 |
| 3.11.2.. Standard SOP Class .....                                      | 16 |
| 3.11.3.. Standard Extended SOP Class .....                             | 16 |
| 3.11.4.. Specialized SOP Class .....                                   | 16 |
| 3.11.5.. Private SOP Class .....                                       | 16 |
| 3.11.6.. Standard Attribute .....                                      | 16 |
| 3.11.7.. Private Attribute .....                                       | 16 |
| 3.11.8.. Standard Application Profile .....                            | 17 |
| 3.11.9.. Augmented Application Profile .....                           | 17 |
| 3.11.10 Private Application Profile .....                              | 17 |
| 3.11.11 Security Profile .....                                         | 17 |
| 4 SYMBOLS AND ABBREVIATIONS .....                                      | 17 |
| 5 CONVENTIONS .....                                                    | 18 |
| 5.1 APPLICATION DATA FLOW DIAGRAM .....                                | 18 |
| 5.1.1 Application Entity .....                                         | 18 |
| 5.1.2 Real-World Activity .....                                        | 18 |
| 5.1.3 Local Relationships .....                                        | 19 |
| 5.1.4 Network-Associations .....                                       | 19 |
| 5.1.5 Media Storage File-set Access .....                              | 20 |
| 6 PURPOSE OF A CONFORMANCE STATEMENT .....                             | 20 |
| 6.1 OVERVIEW OF NETWORKING SECTION FOR CONFORMANCE STATEMENTS .....    | 21 |
| 6.2 OVERVIEW OF MEDIA STORAGE SECTION FOR CONFORMANCE STATEMENTS ..... | 22 |
| 7 CONFORMANCE REQUIREMENTS .....                                       | 22 |
| 7.1 DICOM NETWORK CONFORMANCE REQUIREMENTS .....                       | 23 |
| 7.2 DICOM MEDIA INTERCHANGE CONFORMANCE REQUIREMENTS .....             | 23 |
| 7.3 RULES GOVERNING TYPES OF SOP CLASSES .....                         | 24 |

|         |                                                                  |    |
|---------|------------------------------------------------------------------|----|
| 7.4     | RULES GOVERNING TYPES OF APPLICATION PROFILES .....              | 26 |
| 7.4.1   | Standard Application Profile.....                                | 26 |
| 7.4.2   | Augmented Application Profile.....                               | 26 |
| 7.4.3   | Private Application Profile .....                                | 26 |
| 7.5     | CONFORMANCE OF DICOM MEDIA .....                                 | 27 |
| 7.6     | SECURITY PROFILES.....                                           | 27 |
| ANNEX A | (Normative) DICOM CONFORMANCE STATEMENT TEMPLATE .....           | 28 |
| A.0     | COVER PAGE .....                                                 | 29 |
| A.1     | CONFORMANCE STATEMENT OVERVIEW .....                             | 30 |
| A.2     | TABLE OF CONTENTS.....                                           | 37 |
| A.3     | INTRODUCTION .....                                               | 38 |
| A.3.1   | REVISION HISTORY .....                                           | 38 |
| A.3.2   | AUDIENCE.....                                                    | 38 |
| A.3.3   | REMARKS.....                                                     | 38 |
| A.3.4   | TERMS AND DEFINITIONS .....                                      | 39 |
| A.3.5   | BASICS OF DICOM COMMUNICATION.....                               | 40 |
| A.3.6   | ABBREVIATIONS .....                                              | 41 |
| A.3.7   | REFERENCES.....                                                  | 43 |
| A.4     | NETWORKING .....                                                 | 44 |
| A.4.1   | IMPLEMENTATION MODEL .....                                       | 44 |
| A.4.1.1 | Application Data Flow.....                                       | 44 |
| A.4.1.2 | Functional Definition of AE's .....                              | 45 |
| A.4.1.3 | Sequencing of Real World Activities .....                        | 46 |
| A.4.2   | AE SPECIFICATIONS: .....                                         | 46 |
| A.4.2.1 | “Application Entity <1>” .....                                   | 46 |
| A.4.2.2 | “Application Entity <2>” .....                                   | 51 |
| A.4.3   | NETWORK INTERFACES.....                                          | 51 |
| A.4.3.1 | Physical Network Interface.....                                  | 51 |
| A.4.3.2 | Additional Protocols.....                                        | 52 |
| A.4.4   | CONFIGURATION .....                                              | 52 |
| A.4.4.1 | AE Title/Presentation Address Mapping .....                      | 52 |
| A.4.4.2 | Parameters .....                                                 | 53 |
| A.5     | MEDIA INTERCHANGE .....                                          | 55 |
| A.5.1   | IMPLEMENTATION MODEL .....                                       | 55 |
| A.5.1.1 | Application Data Flow Diagram.....                               | 55 |
| A.5.1.2 | Functional definitions of AE's .....                             | 56 |
| A.5.1.3 | Sequencing of Real World Activities .....                        | 56 |
| A.5.1.4 | File Meta Information for Implementation Class and Version ..... | 56 |
| A.5.2   | AE SPECIFICATIONS .....                                          | 57 |
| A.5.2.1 | “Application Entity <1>” - Specification .....                   | 57 |
| A.5.2.2 | “Application Entity <2>” - Specification .....                   | 58 |
| A.5.3   | AUGMENTED AND PRIVATE APPLICATION PROFILES .....                 | 58 |
| A.5.3.1 | Augmented Application Profiles .....                             | 58 |
| A.5.3.2 | Private Application Profiles.....                                | 58 |
| A.5.4   | MEDIA CONFIGURATION.....                                         | 58 |
| A.6     | SUPPORT OF CHARACTER SETS.....                                   | 59 |
| A.7     | SECURITY .....                                                   | 60 |
| A.7.1   | SECURITY PROFILES .....                                          | 60 |

|                       |                                                                                                             |     |
|-----------------------|-------------------------------------------------------------------------------------------------------------|-----|
| A.7.2                 | ASSOCIATION LEVEL SECURITY .....                                                                            | 60  |
| A.7.3                 | APPLICATION LEVEL SECURITY .....                                                                            | 60  |
| A.8                   | ANNEXES .....                                                                                               | 61  |
| A.8.1                 | IOD CONTENTS .....                                                                                          | 61  |
| A.8.1.1               | Created SOP Instance(s) .....                                                                               | 61  |
| A.8.1.2               | Usage of Attributes from received IOD's .....                                                               | 61  |
| A.8.1.3               | Attribute Mapping .....                                                                                     | 61  |
| A.8.1.4               | Coerced/Modified fields .....                                                                               | 61  |
| A.8.2                 | DATA DICTIONARY OF PRIVATE ATTRIBUTES .....                                                                 | 62  |
| A.8.3                 | CODED TERMINOLOGY AND TEMPLATES .....                                                                       | 62  |
| A.8.3.1               | Context Groups .....                                                                                        | 62  |
| A.8.3.2               | Template Specifications .....                                                                               | 62  |
| A.8.3.3               | Private Code definitions .....                                                                              | 62  |
| A.8.4                 | GRAYSCALE IMAGE CONSISTENCY .....                                                                           | 63  |
| A.8.5                 | STANDARD EXTENDED/SPECIALIZED/PRIVATE SOP CLASSES .....                                                     | 63  |
| A.8.5.1               | Standard Extended/Specialized/Private SOP i .....                                                           | 63  |
| A.8.6                 | PRIVATE TRANSFER SYNTAXES .....                                                                             | 63  |
| A.8.6.1               | Private Transfer Syntax i .....                                                                             | 63  |
| ANNEX B (Informative) | CONFORMANCE STATEMENT SAMPLE INTEGRATED MODALITY .....                                                      | 64  |
| B.0                   | COVER PAGE .....                                                                                            | 65  |
| B.1                   | CONFORMANCE STATEMENT OVERVIEW .....                                                                        | 66  |
| B.2                   | TABLE OF CONTENTS .....                                                                                     | 66  |
| B.3                   | INTRODUCTION .....                                                                                          | 67  |
| B.3.1                 | REVISION HISTORY .....                                                                                      | 67  |
| B.3.2                 | AUDIENCE, REMARKS, TERMS AND DEFINITIONS, BASICS OF DICOM<br>COMMUNICATION, ABBREVIATIONS, REFERENCES ..... | 67  |
| B.3.3                 | ADDITIONAL REMARKS FOR THIS EXAMPLE .....                                                                   | 67  |
| B.4                   | NETWORKING .....                                                                                            | 68  |
| B.4.1                 | .. IMPLEMENTATION MODEL .....                                                                               | 68  |
| B.4.1.1               | Application Data Flow .....                                                                                 | 68  |
| B.4.1.2               | Functional Definition of AEs .....                                                                          | 69  |
| B.4.1.3               | Sequencing of Real-World Activities .....                                                                   | 70  |
| B.4.2                 | AE SPECIFICATIONS .....                                                                                     | 71  |
| B.4.2.1               | Storage Application Entity Specification .....                                                              | 71  |
| B.4.2.2               | Workflow Application Entity Specification .....                                                             | 80  |
| B.4.2.3               | Hardcopy Application Entity Specification .....                                                             | 91  |
| B.4.3                 | NETWORK INTERFACES .....                                                                                    | 102 |
| B.4.3.1               | Physical Network Interface .....                                                                            | 102 |
| B.4.3.2               | Additional Protocols .....                                                                                  | 102 |
| B.4.3.3               | IPv4 and IPv6 Support .....                                                                                 | 104 |
| B.4.4                 | CONFIGURATION .....                                                                                         | 104 |
| B.4.4.1               | AE Title/Presentation Address Mapping .....                                                                 | 104 |
| B.4.4.2               | Parameters .....                                                                                            | 109 |
| B.5                   | MEDIA INTERCHANGE .....                                                                                     | 112 |
| B.5.1                 | IMPLEMENTATION MODEL .....                                                                                  | 112 |
| B.5.1.1               | Application Data Flow .....                                                                                 | 112 |
| B.5.1.2               | Functional Definition of AEs .....                                                                          | 112 |
| B.5.1.3               | Sequencing of Real-World Activities .....                                                                   | 112 |
| B.5.1.4               | File Meta Information Options .....                                                                         | 112 |

|                       |                                                                                                             |     |
|-----------------------|-------------------------------------------------------------------------------------------------------------|-----|
| B.5.2                 | AE SPECIFICATIONS .....                                                                                     | 113 |
| B.5.2.1               | Offline-Media Application Entity Specification .....                                                        | 113 |
| B.5.3                 | AUGMENTED AND PRIVATE APPLICATION PROFILES .....                                                            | 113 |
| B.5.4                 | MEDIA CONFIGURATION.....                                                                                    | 114 |
| B.6                   | SUPPORT OF CHARACTER SETS.....                                                                              | 115 |
| B.7                   | SECURTIY .....                                                                                              | 116 |
| B.8                   | ANNEXES .....                                                                                               | 117 |
| B.8.1                 | IOD CONTENTS .....                                                                                          | 117 |
| B.8.1.1               | Created SOP Instances.....                                                                                  | 117 |
| B.8.1.2               | Used Fields in received IOD by application .....                                                            | 130 |
| B.8.1.3               | Attribute mapping .....                                                                                     | 130 |
| B.8.1.4               | Coerced/Modified Fields.....                                                                                | 131 |
| B.8.2                 | DATA DICTIONARY OF PRIVATE ATTRIBUTES .....                                                                 | 131 |
| B.8.3                 | CODED TERMINOLOGY AND TEMPLATES .....                                                                       | 132 |
| B.8.4                 | GRAYSCALE IMAGE CONSISTENCY .....                                                                           | 132 |
| B.8.5                 | STANDARD EXTENDED / SPECIALIZED / PRIVATE SOP CLASSES.....                                                  | 132 |
| B.8.5.1               | X-Ray Radiofluoroscopic Image Storage SOP Class .....                                                       | 133 |
| B.8.6                 | PRIVATE TRANSFER SYNTAXES .....                                                                             | 133 |
| ANNEX C (Informative) | CONFORMANCE STATEMENT SAMPLE DICOMRIS INTERFACE .....                                                       | 134 |
| C.0                   | COVER PAGE .....                                                                                            | 135 |
| C.1                   | CONFORMANCE STATEMENT OVERVIEW .....                                                                        | 136 |
| C.2                   | TABLE OF CONTENTS .....                                                                                     | 137 |
| C.3                   | INTRODUCTION .....                                                                                          | 138 |
| C.3.1                 | REVISION HISTORY .....                                                                                      | 138 |
| C.3.2                 | AUDIENCE, REMARKS, TERMS AND DEFINITIONS, BASICS OF DICOM<br>COMMUNICATION, ABBREVIATIONS, REFERENCES ..... | 138 |
| C.3.3                 | ADDITIONAL REFERENCES FOR THIS EXAMPLE.....                                                                 | 138 |
| C.3.4                 | ADDITIONAL REMARKS AND DEFINITIONS FOR THIS EXAMPLE .....                                                   | 138 |
| C.4                   | NETWORKING .....                                                                                            | 139 |
| C.4.1                 | IMPLEMENTATION MODEL .....                                                                                  | 139 |
| C.4.1.1               | Application Data Flow.....                                                                                  | 139 |
| C.4.1.2               | Functional Definition of AEs .....                                                                          | 140 |
| C.4.1.3               | Sequencing of Real World Activities .....                                                                   | 140 |
| C.4.2                 | AE SPECIFICATIONS .....                                                                                     | 142 |
| C.4.2.1               | DICOMSRV AE Specification.....                                                                              | 142 |
| C.4.3                 | NETWORK INTERFACES.....                                                                                     | 155 |
| C.4.3.1               | Physical Network Interface.....                                                                             | 155 |
| C.4.3.2               | Additional Protocols.....                                                                                   | 155 |
| C.4.3.3               | IPv4 and IPv6 Support .....                                                                                 | 155 |
| C.4.4                 | CONFIGURATION.....                                                                                          | 155 |
| C.4.4.1               | AE Title/Presentation Address Mapping .....                                                                 | 155 |
| C.4.4.2               | Parameters .....                                                                                            | 156 |
| C.5                   | MEDIA INTERCHANGE .....                                                                                     | 158 |
| C.6                   | SUPPORT OF CHARACTER SETS.....                                                                              | 159 |
| C.7                   | SECURITY .....                                                                                              | 160 |
| C.8                   | ANNEXES .....                                                                                               | 161 |
| C.8.1                 | IOD CONTENTS .....                                                                                          | 161 |

|                       |                                                                                                            |     |
|-----------------------|------------------------------------------------------------------------------------------------------------|-----|
| C.8.1.1               | Created SOP Instances.....                                                                                 | 161 |
| C.8.1.2               | Usage of Attributes from received IOD's.....                                                               | 161 |
| C.8.1.3               | Attribute Mapping .....                                                                                    | 163 |
| C.8.1.4               | Coerced/Modified Fields.....                                                                               | 165 |
| C.8.2                 | DATA DICTIONARY OF PRIVATE ATTRIBUTES .....                                                                | 166 |
| C.8.3                 | CODED TERMINOLOGY AND TEMPLATES .....                                                                      | 167 |
| C.8.4                 | GREYSCALE IMAGE CONSISTENCY .....                                                                          | 167 |
| C.8.5                 | STANDARD EXTENDED/SPECIALIZED/PRIVATE SOP CLASSES .....                                                    | 167 |
| C.8.6                 | PRIVATE TRANSFER SYNTAXES.....                                                                             | 167 |
| ANNEX D (Informative) | CONFORMANCE STATEMENT SAMPLE DICOM Image VIEWER .....                                                      | 168 |
| D.0                   | COVER PAGE .....                                                                                           | 169 |
| D.1                   | COMFORMANCE STATEMENT OVERVIEW.....                                                                        | 170 |
| D.2                   | TABLE OF CONTENTS.....                                                                                     | 174 |
| D.3                   | INTRODUCTION .....                                                                                         | 175 |
| D.3.1                 | REVISION HISTORY.....                                                                                      | 175 |
| D.3.2                 | AUDIENCE, REMARKS, TERMS AND DEFINITIONS, BASICS OF DICOM<br>COMMUNICATION, ABBREVIATIONS, REFERENCES..... | 175 |
| D.3.3                 | ADDITIONAL REMARKS FOR THIS EXAMPLE.....                                                                   | 175 |
| D.4                   | NETWORKING .....                                                                                           | 176 |
| D.4.1                 | IMPLEMENTATION MODEL .....                                                                                 | 176 |
| D.4.1.1               | Application Data Flow.....                                                                                 | 176 |
| D.4.1.2               | Functional Definitions of AE's.....                                                                        | 177 |
| D.4.1.3               | Sequencing of Real-World Activities .....                                                                  | 177 |
| D.4.2                 | AE SPECIFICATIONS .....                                                                                    | 177 |
| D.4.2.1               | ECHO-SCP.....                                                                                              | 177 |
| D.4.2.2               | STORAGE-SCP .....                                                                                          | 179 |
| D.4.2.3               | STORAGE-SCU .....                                                                                          | 183 |
| D.4.2.4               | FIND-SCU .....                                                                                             | 186 |
| D.4.2.5               | MOVE-SCU .....                                                                                             | 191 |
| D.4.3                 | NETWORK INTERFACES.....                                                                                    | 195 |
| D.4.3.1               | Physical Network Interface.....                                                                            | 195 |
| D.4.3.2               | Additional Protocols.....                                                                                  | 195 |
| D.4.3.3               | IPv4 and IPv6 Support .....                                                                                | 195 |
| D.4.4                 | CONFIGURATION.....                                                                                         | 195 |
| D.4.4.1               | AE Title/Presentation Address Mapping .....                                                                | 195 |
| D.4.4.2               | Parameters .....                                                                                           | 195 |
| D.5                   | MEDIA INTERCHANGE .....                                                                                    | 197 |
| D.5.1                 | IMPLEMENTATION MODEL .....                                                                                 | 197 |
| D.5.1.1               | Application Data Flow.....                                                                                 | 197 |
| D.5.1.2               | Functional Definitions of AE's.....                                                                        | 197 |
| D.5.1.3               | Sequencing of Real-World Activities .....                                                                  | 197 |
| D.5.2                 | AE SPECIFICATIONS .....                                                                                    | 197 |
| D.5.2.1               | MEDIA-FSR.....                                                                                             | 197 |
| D.5.3                 | AUGMENTED AND PRIVATE PROFILES .....                                                                       | 198 |
| D.5.3.1               | Augmented Profiles .....                                                                                   | 198 |
| D.5.3.2               | Private Profiles .....                                                                                     | 198 |
| D.5.4                 | MEDIA CONFIGURATION .....                                                                                  | 198 |
| D.6                   | SUPPORT OF CHARACTER SETS.....                                                                             | 199 |
| D.6.1                 | OVERVIEW.....                                                                                              | 199 |

|                       |                                                                                                             |     |
|-----------------------|-------------------------------------------------------------------------------------------------------------|-----|
| D.6.2                 | CHARACTER SETS .....                                                                                        | 199 |
| D.6.3                 | CHARACTER SET CONFIGURATION .....                                                                           | 200 |
| D.7                   | SECURITY .....                                                                                              | 201 |
| D.7.1                 | SECURITY PROFILES .....                                                                                     | 201 |
| D.7.2                 | ASSOCIATION LEVEL SECURITY .....                                                                            | 201 |
| D.7.3                 | APPLICATION LEVEL SECURITY .....                                                                            | 201 |
| D.8                   | ANNEXES .....                                                                                               | 202 |
| D.8.1                 | IOD CONTENTS .....                                                                                          | 202 |
| D.8.1.1               | Created SOP Instances .....                                                                                 | 202 |
| D.8.1.2               | Usage of attributes from received IOD's .....                                                               | 202 |
| D.8.1.3               | Attribute Mapping .....                                                                                     | 202 |
| D.8.1.4               | Coerced/Modified fields .....                                                                               | 202 |
| D.8.2                 | DATA DICTIONARY OF PRIVATE ATTRIBUTES .....                                                                 | 202 |
| D.8.3                 | CODED TERMINOLOGY AND TEMPLATES .....                                                                       | 202 |
| D.8.4                 | GRAYSCALE IMAGE CONSISTENCY .....                                                                           | 202 |
| D.8.6                 | STANDARD EXTENDED/SPECIALIZED/PRIVATE SOP CLASSES .....                                                     | 202 |
| D.8.6                 | PRIVATE TRANSFER SYNTAXES .....                                                                             | 202 |
| ANNEX E (Informative) | CONFORMANCE STATEMENT EXAMPLE-PRINT SERVER .....                                                            | 203 |
| E.0                   | COVER PAGE .....                                                                                            | 204 |
| E.1                   | CONFORMANCE STATEMENT OVERVIEW .....                                                                        | 205 |
| E.2                   | TABLE OF CONTENTS .....                                                                                     | 206 |
| E.3                   | INTRODUCTION .....                                                                                          | 207 |
| E.3.1                 | REVISION HISTORY .....                                                                                      | 207 |
| E.3.2                 | AUDIENCE, REMARKS, TERMS AND DEFINITIONS, BASICS OF DICOM<br>COMMUNICATION, ABBREVIATIONS, REFERENCES ..... | 207 |
| E.3.3                 | ADDITIONAL REMARKS FOR THIS EXAMPLE .....                                                                   | 207 |
| E.4                   | NETWORKING .....                                                                                            | 208 |
| E.4.1                 | IMPLEMENTATION MODEL .....                                                                                  | 208 |
| E.4.1.1               | Application Data Flow .....                                                                                 | 208 |
| E.4.1.2               | Functional Definition of AEs .....                                                                          | 208 |
| E.4.1.3               | Sequencing of Real-World Activities .....                                                                   | 210 |
| E.4.2                 | AE SPECIFICATIONS .....                                                                                     | 212 |
| E.4.2.1               | Print Server Management (SCP) Application Entity Specification .....                                        | 212 |
| E.4.3                 | NETWORK INTERFACES .....                                                                                    | 240 |
| E.4.3.1               | Physical Network Interface .....                                                                            | 240 |
| E.4.3.2               | Additional Protocols .....                                                                                  | 240 |
| E.4.3.3               | IPv4 and IPv6 Support .....                                                                                 | 240 |
| E.4.4                 | CONFIGURATION .....                                                                                         | 241 |
| E.4.4.1               | AE Title/Presentation Address Mapping .....                                                                 | 241 |
| E.4.4.2               | Parameters .....                                                                                            | 241 |
| E.5                   | MEDIA INTERCHANGE .....                                                                                     | 244 |
| E.6                   | SUPPORT OF CHARACTER SETS .....                                                                             | 245 |
| E.7                   | SECURITY .....                                                                                              | 246 |
| E.8                   | ANNEXES .....                                                                                               | 247 |
| E.8.1                 | IOD CONTENTS .....                                                                                          | 247 |
| E.8.1.1               | Created IOD Instance(s) .....                                                                               | 247 |
| E.8.1.2               | Usage of Attributes from received IOD's .....                                                               | 247 |



|                                                                                                                   |     |
|-------------------------------------------------------------------------------------------------------------------|-----|
| E.8.1.3 Attribute Mapping .....                                                                                   | 247 |
| E.8.1.4 Coerced/Modified Fields.....                                                                              | 248 |
| E.8.2 DATA DICTIONARY OF PRIVATE ATTRIBUTES .....                                                                 | 248 |
| E.8.3 CODED TERMINOLOGY AND TEMPLATES .....                                                                       | 248 |
| E.8.4 GRAYSCALE IMAGE CONSISTENCY .....                                                                           | 248 |
| E.8.5 STANDARD EXTENDED / SPECIALIZED / PRIVATE SOP CLASSES .....                                                 | 248 |
| E.8.5.1 Standard Extended Basic Film Session SOP Class .....                                                      | 248 |
| E.8.5.2 Standard Extended Basic Film Box SOP Class .....                                                          | 249 |
| E.8.5.3 Standard Extended Basic Grayscale Image Box SOP Class .....                                               | 249 |
| E.8.6 PRIVATE TRANSFER SYNTAXES .....                                                                             | 249 |
| ANNEX F (informative) DICOM CONFORMANCE STATEMENT QUERY-RETRIEVE-SERVER.....                                      | 250 |
| F.0 COVER PAGE .....                                                                                              | 251 |
| F.1 CONFORMANCE STATEMENT OVERVIEW .....                                                                          | 252 |
| F.2 TABLE OF CONTENTS .....                                                                                       | 253 |
| F.3 INTRODUCTION .....                                                                                            | 254 |
| F.3.1 REVISION HISTORY .....                                                                                      | 254 |
| F.3.2 AUDIENCE, REMARKS, TERMS AND DEFINITIONS, BASICS OF DICOM<br>COMMUNICATION, ABBREVIATIONS, REFERENCES ..... | 254 |
| F.3.3 ADDITIONAL REMARKS FOR THIS EXAMPLE .....                                                                   | 254 |
| F.4 NETWORKING .....                                                                                              | 255 |
| F.4.1 IMPLEMENTATION MODEL.....                                                                                   | 255 |
| F.4.1.1 Application Data Flow.....                                                                                | 255 |
| F.4.1.2 Functional Definition of AEs .....                                                                        | 256 |
| F.4.1.3 Sequencing of Real-World Activities .....                                                                 | 257 |
| F.4.2 AE SPECIFICATIONS.....                                                                                      | 257 |
| F.4.2.1 STORAGE-SCU Application Entity Specification.....                                                         | 257 |
| F.4.2.2 QUERY-RETRIEVE-SCP Application Entity Specification .....                                                 | 265 |
| F.4.2.3 STORAGE-SCP Application Entity Specification .....                                                        | 274 |
| F.4.3 NETWORK INTERFACES .....                                                                                    | 288 |
| F.4.3.1 Physical Network Interface.....                                                                           | 288 |
| F.4.3.2 Additional Protocols.....                                                                                 | 288 |
| F.4.3.3 IPv4 and IPv6 Support .....                                                                               | 289 |
| F.4.4 CONFIGURATION .....                                                                                         | 289 |
| F.4.4.1 AE Title/Presentation Address Mapping .....                                                               | 289 |
| F.4.4.2 Parameters .....                                                                                          | 289 |
| F.5 MEDIA INTERCHANGE .....                                                                                       | 292 |
| F.6 SUPPORT OF EXTENDED CHARACTER SETS .....                                                                      | 292 |
| F.7 SECURITY .....                                                                                                | 292 |
| F.7.1 SECURITY PROFILES .....                                                                                     | 292 |
| F.7.2 ASSOCIATION LEVEL SECURITY .....                                                                            | 292 |
| F.8 ANNEXES .....                                                                                                 | 293 |
| F.8.1 .. IOD CONTENTS.....                                                                                        | 293 |
| F.8.1.1 Storage-SCP AE Element Use.....                                                                           | 293 |
| F.8.1.2 Storage-SCU AE Element modification.....                                                                  | 296 |
| ANNEX G (Informative) CONFORMANCE STATEMENT SAMPLE ImageViewer with Hanging Protocol<br>Support .....             | 297 |
| G.0 COVER PAGE .....                                                                                              | 298 |
| G.1 CONFORMANCE STATEMENT OVERVIEW .....                                                                          | 299 |

|                       |                                                                                                             |     |
|-----------------------|-------------------------------------------------------------------------------------------------------------|-----|
| G.2                   | TABLE OF CONTENTS.....                                                                                      | 300 |
| G.3                   | INTRODUCTION .....                                                                                          | 300 |
| G.3.1                 | Revision History .....                                                                                      | 300 |
| G.3.2                 | AUDIENCE, REMARKS, TERMS AND DEFINITIONS, BASICS OF DICOM<br>COMMUNICATION, ABBREVIATIONS, REFERENCES ..... | 300 |
| G.3.3                 | ADDITIONAL REMARKS FOR THIS EXAMPLE .....                                                                   | 300 |
| G.4                   | NETWORKING .....                                                                                            | 301 |
| G.4.1                 | Implementation Model.....                                                                                   | 301 |
| G.4.2                 | AE Specifications .....                                                                                     | 302 |
| G.4.3                 | Network Interfaces .....                                                                                    | 315 |
| G.4.3.3               | IPv4 and IPv6 Support .....                                                                                 | 315 |
| G.4.4                 | Configuration .....                                                                                         | 315 |
| G.5                   | MEDIA INTERCHANGE .....                                                                                     | 317 |
| G.6                   | SUPPORT OF CHARACTER SETS .....                                                                             | 317 |
| G.6.1                 | Overview .....                                                                                              | 317 |
| G.6.2                 | Character Sets .....                                                                                        | 317 |
| G.6.3                 | Character Set Configuration.....                                                                            | 317 |
| G.7                   | SECURITY.....                                                                                               | 317 |
| G.7.1                 | Security Profiles .....                                                                                     | 317 |
| G.7.2                 | Association Level Security .....                                                                            | 317 |
| G.7.3                 | Application Level Security .....                                                                            | 317 |
| G.8                   | ANNEXES.....                                                                                                | 317 |
| G.8.1                 | IOD Contents.....                                                                                           | 317 |
| G.8.2                 | Data Dictionary of Private Attributes .....                                                                 | 323 |
| G.8.3                 | Coded Terminology and Templates .....                                                                       | 323 |
| G.8.4                 | Grayscale Image Consistency .....                                                                           | 323 |
| G.8.5                 | Standard Extended/Specialized/Private SOP Classes .....                                                     | 323 |
| G.8.6                 | Private Transfer Syntaxes.....                                                                              | 323 |
| ANNEX H (informative) | DICOM CONFORMANCE STATEMENT MEDICATION-SYSTEM-GATEWAY.....                                                  | 324 |
| H.0                   | COVER PAGE .....                                                                                            | 325 |
| H.1                   | CONFORMANCE STATEMENT OVERVIEW .....                                                                        | 325 |
| H.2                   | TABLE OF CONTENTS.....                                                                                      | 326 |
| H.3                   | INTRODUCTION .....                                                                                          | 326 |
| H.3.1                 | REVISION HISTORY.....                                                                                       | 326 |
| H.3.2                 | AUDIENCE, REMARKS, TERMS AND DEFINITIONS, BASICS OF DICOM<br>COMMUNICATION, ABBREVIATIONS, REFERENCES ..... | 326 |
| H.3.3                 | ADDITIONAL REMARKS FOR THIS EXAMPLE.....                                                                    | 326 |
| H.4                   | NETWORKING .....                                                                                            | 327 |
| H.4.1                 | IMPLEMENTATION MODEL .....                                                                                  | 327 |
| H.4.1.1               | Application Data Flow.....                                                                                  | 327 |
| H.4.1.2               | Functional Definition of AEs .....                                                                          | 327 |
| H.4.1.3               | Sequencing of Real-World Activities .....                                                                   | 328 |
| H.4.2                 | AE SPECIFICATIONS .....                                                                                     | 328 |
| H.4.2.1               | PHARMACY-SCP Application Entity Specification .....                                                         | 328 |
| H.4.2.2               | MAR-SCP Application Entity Specification.....                                                               | 334 |
| H.4.3                 | NETWORK INTERFACES.....                                                                                     | 338 |
| H.4.3.1               | Physical Network Interface.....                                                                             | 338 |
| H.4.3.2               | Additional Protocols.....                                                                                   | 339 |
| H.4.4                 | CONFIGURATION.....                                                                                          | 340 |
| H.4.4.1               | AE Title/Presentation Address Mapping .....                                                                 | 340 |

|                                              |     |
|----------------------------------------------|-----|
| H.4.4.2 Parameters .....                     | 340 |
| H.5 MEDIA INTERCHANGE .....                  | 342 |
| H.6 SUPPORT OF EXTENDED CHARACTER SETS ..... | 342 |
| H.7 SECURITY .....                           | 342 |
| H.7.1 SECURITY PROFILES .....                | 342 |
| H.7.2 ASSOCIATION LEVEL SECURITY .....       | 342 |

## FOREWORD

The American College of Radiology (ACR) and the National Electrical Manufacturers Association (NEMA) formed a joint committee to develop a standard for Digital Imaging and Communications in Medicine (DICOM). This DICOM Standard was developed according to the NEMA procedures.

This standard is developed in liaison with other standardization organizations including CEN TC251 in Europe and JIRA in Japan, with review also by other organizations including IEEE, HL7 and ANSI in the USA.

The DICOM Standard is structured as a multi-part document using the guidelines established in the following document:

- ISO/IEC Directives, 1989 Part 3: Drafting and Presentation of International Standards.

This document is a Supplement to the DICOM Standard. It replaces PS 3.2

|         |                                                                     |
|---------|---------------------------------------------------------------------|
| PS 3.1  | Introduction and Overview                                           |
| PS 3.2  | Conformance                                                         |
| PS 3.3  | Information Object Definitions                                      |
| PS 3.4  | Service Class Specifications                                        |
| PS 3.5  | Data Structures and Encoding                                        |
| PS 3.6  | Data Dictionary                                                     |
| PS 3.7  | Message Exchange                                                    |
| PS 3.8  | Network Communication Support for Message Exchange                  |
| PS 3.9  | Retired (Point-to-Point Communication Support for Message Exchange) |
| PS 3.10 | Media Storage and File Format for Data Interchange                  |
| PS 3.11 | Media Storage Application Profiles                                  |
| PS 3.12 | Media Formats and Physical Media for Data Interchange               |
| PS 3.13 | Retired (Print Management Point-to-Point Communication Support)     |
| PS 3.14 | Grayscale Display Function Standard                                 |
| PS 3.15 | Security and Configuration Management Profiles                      |
| PS 3.16 | Content Mapping Resource                                            |
| PS 3.17 | Explanatory Information                                             |
| PS 3.18 | Web Access to DICOM Persistent Objects (WADO)                       |

These parts are related but independent documents. Their development level and approval status may differ. Additional parts may be added to this multi-part standard. PS 3.1 should be used as the base reference for the current parts of this standard.

## 1 SCOPE AND FIELD OF APPLICATION

Conformance Statements are critical to interoperability because they provide important information for implementers and system integrators in order to determine whether or not applications do interoperate. In addition, when issues occur, they provide a source of information in order to potentially resolve any problems. Lastly, it is important to provide potential implementers with a consistent template for generating these documents.

PS 3.2 defines principles that implementations claiming conformance to the Standard shall follow. PS 3.2 specifies:

- the minimum general conformance requirements that must be met by any implementation claiming conformance to the DICOM Standard. Additional conformance requirements for particular features, Service Classes, Information Objects, and communications protocols may be found in the conformance sections of other Parts of the DICOM Standard;
- the purpose and structure of a Conformance Statement. PS 3.2 provides a framework by which conformance information can be placed into a Conformance Statement as dictated by the conformance sections of other Parts of the DICOM Standard.

The DICOM Standard does not specify:

- testing or validation procedures to assess an implementation's conformance to the Standard;
- testing or validation procedures to assess whether an implementation matches to its Conformance Statement;
- what optional features, Service Classes, or Information Objects should be supported for a given type of device.

## 2 NORMATIVE REFERENCES

The following standards contain provisions, which, through reference in this text, constitute provisions of this Standard. At the time of publication, the editions indicated were valid. All standards are subject to revision, and parties to agreements based on this Standard are encouraged to investigate the possibilities of applying the most recent editions of the standards indicated below.

ISO/IEC Directives 1989 Part 3 - Drafting and presentation of International Standards.

ISO 7498-1 Information Processing Systems - Open Systems Interconnection - Basic Reference Model.

ISO 8649:1988 Information Processing Systems -- Open Systems Interconnection - Service definition for the Association Control Service Element (ACSE).

ISO 8822:1988 Information Processing Systems -- Open Systems Interconnection - Connection oriented presentation service definition.

ISO/IEC 10646-1:2000 Information Technology -- Universal Multiple-Octet Coded Character Set (UCS) -- Part 1: Architecture and Basic Multilingual Plane

ISO/IEC 10646-1:2000/Amd 1:2002 Mathematical symbols and other characters

ISO/IEC 10646-2:2001 Information Technology -- Universal Multiple-Octet Coded Character Set (UCS) -- Part 2: Supplementary Planes

- Standard -

### 3 DEFINITIONS

For the purposes of this Standard the following definitions apply.

#### 3.1 REFERENCE MODEL DEFINITIONS

This Part makes use of the following terms defined in ISO 7498-1:

- a. a. Application Entity
- b. b. Application Entity Title
- c. c. Protocol Data Unit
- d. d. Transfer Syntax.

#### 3.2 ACSE SERVICE DEFINITIONS

This Part makes use of the following terms defined in ISO 8649:

- a. Association or Application Association
- b. Association Initiator.

#### 3.3 PRESENTATION SERVICE DEFINITIONS

This Part makes use of the following terms defined in ISO 8822:

- a. Abstract Syntax
- b. Abstract Syntax Name
- c. Presentation Context
- d. Transfer Syntax
- e. Transfer Syntax Name.

#### 3.4 DICOM INTRODUCTION AND OVERVIEW DEFINITIONS

This Part makes use of the following terms defined in PS 3.1:

- a. Information Object

#### 3.5 DICOM INFORMATION OBJECT DEFINITIONS

This Part makes use of the following terms defined in PS 3.3:

- a. Information Object Definition (IOD).

#### 3.6 DICOM SERVICE CLASS SPECIFICATION DEFINITIONS

This Part makes use of the following terms defined in PS 3.4:

- a. Real-World Activity

- b. Service Class.
- c. Service Class User (SCU)
- d. Service Class Provider (SCP)
- e. Service-Object Pair (SOP) Class
- f. Meta SOP Class.

### **3.7 DICOM DATA STRUCTURE AND ENCODING DEFINITIONS**

This Part makes use of the following terms defined in PS 3.5:

- a. DICOM Defined UID
- b. Privately Defined UID
- c. Transfer Syntax: (Standard and Private)
- d. Unique Identifier (UID).

### **3.8 DICOM MESSAGE EXCHANGE DEFINITIONS**

This Part makes use of the following terms defined in PS 3.7:

- a. Extended Negotiation
- b. Implementation Class UID.

### **3.9 DICOM UPPER LAYER SERVICE DEFINITIONS**

This Part makes use of the following terms defined in PS 3.8:

- a. Unique Identifier (UID)
- b. DICOM Upper Layer Service
- c. Presentation Address.

### **3.10 MEDIA STORAGE AND FILE FORMAT FOR DATA INTERCHANGE**

This Part makes use of the following terms defined in PS 3.10:

- a. File-set
- b. File-set Creator (FSC)
- c. File-set Reader (FSR)
- d. File-set Updater (FSU)
- e. Application Profile

### **3.11 DICOM CONFORMANCE**

This Part uses the following definitions:

#### **3.11.1 Conformance Statement**

A formal statement associated with a specific implementation of the DICOM Standard. It specifies the Service Classes, Information Objects, Communications Protocols and Media Storage Application Profiles supported by the implementation.

### **3.11.2 Standard SOP Class**

A SOP Class defined in the DICOM Standard that is used in an implementation with no modifications.

### **3.11.3 Standard Extended SOP Class**

A SOP Class defined in the DICOM Standard extended in an implementation with additional Type 3 Attributes. The additional Attributes may either be drawn from the Data Dictionary in PS 3.6, or may be Private Attributes. The semantics of the related Standard SOP Class shall not be modified by the additional Type 3 Attributes when absent. Therefore, the Standard Extended SOP Class utilizes the same UID as the related Standard SOP Class.

Note: IODs from a Standard Extended SOP Class may be freely exchanged between DICOM implementations since implementations unfamiliar with the additional Type 3 Attributes would simply ignore them.

### **3.11.4 Specialized SOP Class**

A SOP Class derived from a Standard SOP Class that has been specialized in an implementation by additional Type 1, 1C, 2, 2C, or 3 Attributes, by enumeration of specific permitted values for Attributes, or by enumeration of specific permitted Templates. The additional Attributes may either be drawn from the Data Dictionary in PS 3.6, or may be Private Attributes. The enumeration of permitted Attribute values or Templates shall be a subset of those permitted in the related Standard SOP Class. Since the semantics of the related Standard SOP Class may be modified by the additional Attributes, a Specialized SOP Class utilizes a Privately Defined UID which differs from the UID for the related Standard SOP Class.

Notes:

1. Since a Specialized SOP Class has a different UID than a Standard or Standard Extended SOP Class, other DICOM implementations may not recognize the Specialized SOP Class. Because of this limitation, a Specialized SOP Class should only be used when a Standard or Standard Extended SOP Class would not be appropriate. Before different implementations can exchange Instances in a Specialized SOP Class, the implementations must agree on the UID, content (in particular the additional Type 1, 1C, 2, and 2C Attributes), and semantics of the Specialized SOP Class. A Specialized SOP Class may be used to create a new or experimental SOP Class that is closely related to a Standard SOP Class.
2. The Association Negotiation for a Specialized SOP Class may include a SOP Class Common Extended Negotiation Sub-Item (as defined in PS 3.7) for identification of the Service Class and of the Related General SOP Class from which it was specialized. This may allow a receiving application, without prior agreement on the Specialized SOP Class IOD, to process Instances of that class as if they were instances of a Related General SOP Class.

### **3.11.5 Private SOP Class**

A SOP Class that is not defined in the DICOM Standard, but is published in an implementation's Conformance Statement.

Note: Since a Private SOP Class is not defined in the DICOM Standard, other DICOM implementations may not recognize the Private SOP Class. Because of this limitation, a Private SOP Class should only be used when a Standard or Standard Extended SOP Class would not be appropriate. In order for different implementations to exchange Instances in a Private SOP Class, the implementations must agree on the UID, content (in particular the Type 1, 1C, 2, and 2C Attributes), and semantics of the Private SOP Class. A Private SOP class may be used to create a totally new or experimental SOP Class.

### **3.11.6 Standard Attribute**

An Attribute defined in the Data Dictionary in PS 3.6.

### **3.11.7 Private Attribute**

An Attribute that is not defined in the DICOM Standard.



### **3.11.8 Standard Application Profile**

An Application Profile defined in the DICOM Standard that is used in an implementation with no modifications.

### **3.11.9 Augmented Application Profile**

An Application Profile derived from a Standard Application Profile by incorporating support for additional Standard or Standard Extended SOP Classes.

### **3.11.10 Private Application Profile**

An Application Profile that is not defined in the DICOM Standard, but is published in an implementation's Conformance Statement.

### **3.11.11 Security Profile**

A mechanism for selecting an appropriate set of choices from the Parts of the DICOM standard along with corresponding security mechanisms (e.g. encryption algorithms) for the support of security facilities.

## **4 SYMBOLS AND ABBREVIATIONS**

The following symbols and abbreviations are used in this Part.

|           |                                                                                  |
|-----------|----------------------------------------------------------------------------------|
| ACR       | American College of Radiology                                                    |
| ACSE      | Association Control Service Element                                              |
| AE        | Application Entity                                                               |
| ANSI      | American National Standards Institute                                            |
| AP        | Application Profile                                                              |
| API       | Application Programming Interface                                                |
| ASCII     | American Standard Code for Information Interchange                               |
| CEN TC251 | Comite Europeen de Normalisation-Technical Committee 251-<br>Medical Informatics |
| DICOM     | Digital Imaging and Communications in Medicine                                   |
| DIMSE     | DICOM Message Service Element                                                    |
| DIMSE-C   | DICOM Message Service Element-Composite                                          |
| DIMSE-N   | DICOM Message Service Element-Normalized                                         |
| FSC       | File-set Creator                                                                 |
| FSR       | File-set Reader                                                                  |
| FSU       | File-set Updater                                                                 |
| HISPP     | Healthcare Informatics Standards Planning Panel                                  |
| HL7       | Health Level 7                                                                   |
| IE        | Information Entity                                                               |
| IEEE      | Institute of Electrical and Electronics Engineers                                |
| IOD       | Information Object Definition                                                    |
| ISO       | International Standards Organization                                             |

|        |                                                      |
|--------|------------------------------------------------------|
| ISP    | International Standardized Profile                   |
| JIRA   | Japanese Industry Radiology Apparatus                |
| MSDS   | Healthcare Message Standard Developers Sub-Committee |
| NEMA   | National Electrical Manufacturers Association        |
| OSI    | Open Systems Interconnection                         |
| PDU    | Protocol Data Unit                                   |
| RWA    | Real-World Activity                                  |
| SCP    | Service Class Provider                               |
| SCU    | Service Class User                                   |
| SOP    | Service-Object Pair                                  |
| TCP/IP | Transmission Control Protocol/Internet Protocol      |
| UID    | Unique Identifier                                    |
| UML    | Unified Modeling Language                            |

## 5 CONVENTIONS

### 5.1 APPLICATION DATA FLOW DIAGRAM

In a Conformance Statement, the relationships between Real-World Activities and Application Entities are illustrated by an Application Data Flow Diagram.

#### 5.1.1 Application Entity

An Application Entity is depicted as a box in an Application Data Flow Diagram, shown in Figure 5.1-1



**Figure 5.1-1**  
**APPLICATION ENTITY CONVENTION**

#### 5.1.2 Real-World Activity

A Real-World Activity is depicted as a circle in an Application Data Flow Diagram, shown in Figure 5.1-2.

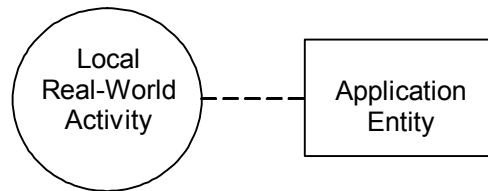


**Figure 5.1-2**  
**REAL-WORLD ACTIVITY CONVENTION**

Circles representing multiple Real-World Activities may overlap, indicating a degree of overlap in the Real-World Activities.

### 5.1.3 Local Relationships

A relationship between a local Real-World Activity and an Application Entity is depicted within an Application Data Flow Diagram by placing the local Real-World Activity to the left of the related Application Entity with a dashed line between them as shown in Figure 5.1-3.



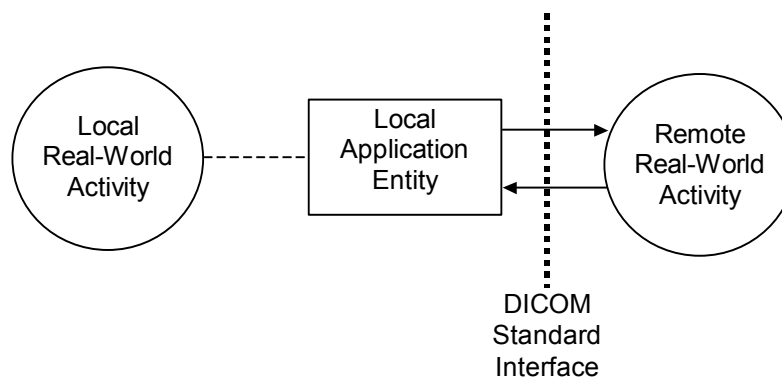
**Figure 5.1-3**  
**LOCAL RELATIONSHIP CONVENTION**

An Application Entity may be associated with multiple Real-World Activities.

A Real-World Activity may be associated with multiple Application Entities.

### 5.1.4 Network-Associations

An association between a local Application Entity and a remote Application Entity over a network supporting a remote Real-World Activity is depicted within an Application Data Flow Diagram by placing the remote Real-World Activity to the right of the related local Application Entity with one or two arrows drawn between them as shown in Figure 5.1-4. The dashed line represents the DICOM Standard Interface between the local Application Entities, and whatever remote Application Entities that handle the remote Real-World Activities. An arrow from the local Application Entity to the remote Real-World Activity indicates that an occurrence of the local Real-World Activity will cause the local Application Entity to initiate an association for the purpose of causing the remote Real-World Activity to occur. An arrow from the remote Real-World Activity to the local Application Entity indicates that the local Application Entity expects to receive an association request when the remote Real-World Activity occurs, causing the local Application Entity to perform the local Real-World Activity.



### Figure 5.1-4 ASSOCIATIONS CONVENTION

#### 5.1.5 Media Storage File-set Access

Application Entities exchanging information on media use the DICOM File Service as specified in PS 3.10 for access to, or creation of, File-sets. This File Service provides operations that support three basic roles, which are File-set Creator (FSC), File-set Reader (FSR), and File-set Updater (FSU).

These roles are depicted on an Application Data Flow diagram by directional arrows placed between the local Application Entities and the DICOM Storage Media on which the roles are applied.




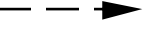
- File-set Creator (FSC), denoted by  ;
- File-set Reader (FSR), denoted by  ;
- File-set Updater (FSU), denoted by  ;
- Physical movement of the medium, denoted by  (with or without arrowhead)

Figure 5.1-5 illustrates the three basic roles.

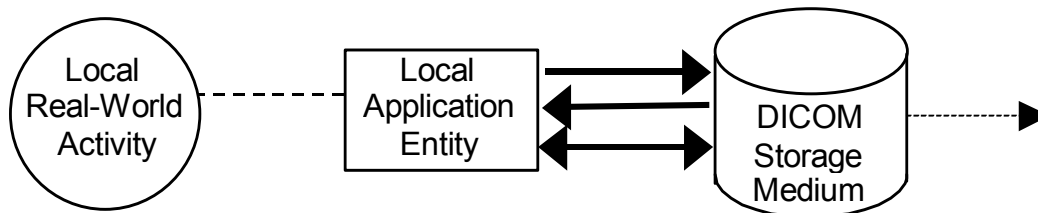


Figure 5.1-5  
FILE-SET ACCESS

The local interactions shown on the left between a local Real-World activity and a local Application Entity are depicted by a dashed line. The arrows on the right represent access by the local Application Entity to a File-set on the DICOM Storage Medium. When an Application Entity supports several roles, this combination is depicted with multiple arrows corresponding to each of the roles. The dotted arrow symbolizes the removable nature of media for an interchange application.

Note: The use of two arrows relative to an FSC and an FSR should be distinguished from the case where a double arrow relative to an FSU is used. For example, an FSU may update a File-set without creating a new File-set, whereas a combined FSC and FSR may be used to create and verify a File-set.

## 6 PURPOSE OF A CONFORMANCE STATEMENT

An implementation need not employ all the optional components of the DICOM Standard. After meeting the minimum general requirements, a conformant DICOM implementation may utilize whatever SOP Classes, communications protocols, Media Storage Application Profiles, optional (Type 3) Attributes, codes and controlled terminology, etc., needed to accomplish its designed task.

Note: In fact, it is expected that an implementation might only support the SOP Classes related to its Real World Activities. For example, a simple film digitizer may not support the SOP Classes for other imaging modalities since such support may not be required. On the other hand, a complex storage server might be required to support SOP Classes from multiple modalities in order to adequately function as a storage server. The choice of which components of the DICOM Standard are utilized by an implementation depends heavily on the intended application and is beyond the scope of this Standard.

In addition, the DICOM Standard allows an implementation to extend or specialize the DICOM defined SOP Classes, as well as define Private SOP classes.

A Conformance Statement allows a user to determine which optional components of the DICOM Standard are supported by a particular implementation, and what additional extensions or specializations an implementation adds. By comparing the Conformance Statements from two different implementations, a knowledgeable user should be able to determine whether and to what extent communications might be supported between the two implementations.

Different structures are used for the content of Conformance Statements depending on whether the implementation supports a DICOM network interface, a DICOM Media Storage interface, or a combination thereof. In the latter case, a single Conformance Statement shall be provided which consists of the appropriate sections.

The first part of the conformance statement contains a DICOM Conformance Statement Overview, which is typically a one-page description in the beginning of the document providing a high level description and also listing the Networking and Media Service Classes, including their roles (SCU/SCP, FSC, FSR, etc.).

## 6.1 OVERVIEW OF NETWORKING SECTION FOR CONFORMANCE STATEMENTS

The networking section of a Conformance Statement consists of the following major parts:

- a functional overview containing the Application Data Flow Diagram that shows all the Application Entities, including any sequencing constraints among them. It also shows how they relate to both local and remote Real World Activities;
- a more detailed specification of each Application Entity, listing the SOP Classes supported and outlining the policies with which it initiates or accepts associations;
- for each Application Entity and Real-World Activity combination, a description of proposed (for Association Initiation) and acceptable (for Association Acceptance) Presentation Contexts;

Note: A Presentation Context consists of an Abstract Syntax plus a list of acceptable Transfer Syntaxes. The Abstract Syntax identifies one SOP Class or Meta SOP Class (a collection of related SOP Classes identified by a single Abstract Syntax UID). By listing the Application Entities with their proposed and accepted Presentation Contexts, the Conformance Statement is identifying the set of Information Objects and Service Classes which are recognized by this implementation;

- for each SOP Class related to an Abstract Syntax, a list of any SOP options supported;
- a set of communications protocols which this implementation supports;
- a description of any extensions, specializations, and publicly disclosed privatizations in this implementation;
- a section describing DICOM related configuration details;

- a description of any implementation details which may be related to DICOM conformance or interoperability;
- a description of what codes and controlled terminology mechanisms are used.

## **6.2 OVERVIEW OF MEDIA STORAGE SECTION FOR CONFORMANCE STATEMENTS**

The media storage section of a Conformance Statement consists of the following major parts:

- a functional overview containing the Application Data Flow Diagram which shows all the Application Entities, including any sequencing constraints among them. It also shows how they relate to both local and remote Real-World Activities;
  - a more detailed specification of each Application Entity listing the Media Storage Application Profiles supported (this defines SOP Classes supported and media selected), which outlines the policies with which it creates, reads, or updates File-sets on the media;
  - a list of optional SOP Classes supported;
  - for each Media Storage SOP Class related to a media storage Application Profile, a list of any SOP options supported;
  - for each Media Storage SOP Class related to a media storage Application Profile, a list of optional Transfer Syntaxes supported;
  - a description of any extensions, specializations, and publicly disclosed privatizations in this implementation such as Augmented or Private Application Profiles;
  - a section describing DICOM related configuration details;
- a description of any implementation details which may be related to DICOM conformance or interoperability;
- a description of what codes and controlled terminology mechanisms are used.

## **7 CONFORMANCE REQUIREMENTS**

An implementation claiming DICOM conformance may choose to support one of the following:

- network conformance according to Section 7.1 (DICOM Network Conformance Requirements);
- media storage conformance according to Section 7.2 (DICOM Media Storage Conformance Requirements);
- both of the above.

## 7.1 DICOM NETWORK CONFORMANCE REQUIREMENTS

An implementation claiming DICOM network conformance shall:

- conform to the minimum conformance requirements defined in this section;
- provide with the implementation a Conformance Statement structured according to the rules and policies in this Part including Annex A;
- conform to at least one Standard or Standard Extended SOP class as defined in PS 3.4;

Note: Conformance to a Standard or Standard Extended SOP class implies conformance to the related IOD outlined in PS 3.3, the Data Elements defined in PS 3.6, and the operations and notifications defined in PS 3.7.

- comply with the rules governing SOP Class types outlined in Section 7.3;
- accept a Presentation Context for the Verification SOP Class as an SCP if the implementation accepts any DICOM association requests;
- produce and/or process Data Sets as defined in PS 3.5;

Note: Conformance to PS 3.5 also implies conformance to PS 3.6.

- obtain legitimate right to a registered <org id> for creating UIDs (see PS 3.5) if an implementation utilizes Privately Defined UIDs (i.e., UIDs not defined in the DICOM Standard);
- support the following communication mode:
- TCP/IP (See PS 3.8),

## 7.2 DICOM MEDIA INTERCHANGE CONFORMANCE REQUIREMENTS

An implementation claiming DICOM Media Interchange conformance shall:

- conform to the minimum conformance requirements defined in this section;
- provide with the implementation a Conformance Statement structured according to the rules and policies in this Part including Annex C;
- conform to at least one Standard Application Profile as defined in PS 3.11;
- support one of the Physical Media and associated Media Format, as specified by PS 3.12;
- comply with the rules governing SOP Class types outlined in Section 7.3;
- comply with the specific rules governing media storage Application Profile according to their types as specified in Section 7.4. No other types of Application Profiles may be used;
- read as an FSR or FSU all SOP Classes defined as mandatory by each of the supported Application Profiles encoded in any of the mandatory Transfer Syntaxes.
- write as an FSC or FSU all SOP Classes defined as mandatory by each of the supported Application Profiles in one of the mandatory Transfer Syntaxes;
- be able to gracefully ignore any Standard, Standard Extended, specialized or Private SOP Classes which may be present on the Storage Medium but are not defined in any of the Application Profiles to which conformance is claimed.

Note: There may be more than one Application Profile used to create or read a File-set on a single physical medium (e.g., a medium may have a File-set created with Standard and Augmented Application Profiles).

- be able to gracefully ignore Directory Records in the DICOMDIR file which do not correspond to Directory Records defined in any of the Application Profiles to which conformance is claimed.
- access the File-set(s) on media using the standard roles defined in PS 3.10;
- produce and/or process Data Sets as defined in PS 3.5 encapsulated in DICOM Files;

Note: Conformance to PS 3.5 also implies conformance to PS 3.6

- obtain legitimate right to a registered <org id> for creating UIDs (see PS 3.5) if an implementation utilizes Privately Defined UIDs (i.e., UIDs not defined in the DICOM Standard).

An implementation which does not meet all the above requirements shall not claim conformance to DICOM for Media Storage Interchange.

### 7.3 RULES GOVERNING TYPES OF SOP CLASSES

Each SOP Class published in a Conformance Statement is one of four basic types. Each SOP Class in an implementation claiming conformance to the DICOM Standard shall be handled in accordance with the following rules, as dictated by the type of SOP Class.

Standard SOP Classes conform to all relevant Parts of the DICOM Standard with no additions or changes.

To claim conformance to a Standard SOP Class, an implementation shall make a declaration of this fact in its Conformance Statement, and identify its selected options, roles, and behavior.

Standard Extended SOP Classes shall:

- a. be a proper super set of one Standard SOP Class;
- b. not change the semantics of any Standard Attribute of that Standard SOP Class;
- c. not contain any Private Type 1, 1C, 2, or 2C Attributes, nor add additional Standard Type 1, 1C, 2 or 2C Attributes;
- d. not change any Standard Type 3 Attributes to Type 1, 1C, 2, or 2C;
- e. use the same UID as the Standard SOP Class on which it is based.

A Standard Extended SOP Class may include Standard and/or Private Type 3 Attributes beyond those defined in the IOD on which it is based as long as the Conformance Statement identifies the added Attributes and defines their relationship with the PS 3.3 information model.

An implementation claiming conformance with a Standard Extended SOP Class shall identify in its Conformance Statement the Standard SOP Class being extended, the options, roles, and behavior selected, and describe the Attributes being added with the Standard SOP Class's IOD Model and Modules.

Specialized SOP Classes shall:

- a. be completely conformant to relevant Parts of the DICOM Standard;
- b. be based on a Standard SOP Class, i.e.:
  - contain all the Type 1, 1C, 2, and 2C Attributes of Standard SOP Class on which it is based;



- not change the semantics of any Standard Attribute;
  - use a Privately Defined UID for its SOP Class (i.e., shall not be identified with a DICOM Defined UID);
- c. be based on the DICOM Information Model in PS 3.3 and PS 3.4.

Specialized SOP Classes may:

- a. contain additional Standard and/or Private Type 1, 1C, 2, or 2C Attributes;
- b. add Private and Standard Type 3 Attributes which may or may not be published in the Conformance Statement.

Note: The usage of any unpublished Attributes may be ignored by other users and providers of the Specialized SOP Class.

- c. enumerate the permitted values for Attributes within the set allowed by the Standard SOP Class;
- d. enumerate the permitted Templates for Content Items within the set allowed by the Standard SOP Class.

An implementation claiming conformance with a Specialized SOP Class shall include in its Conformance Statement the identity of the Standard SOP Class being specialized, a description of usage of all Standard and Private Type 1, 1C, 2, and 2C Attributes in the Specialized SOP Class, a description of the constraints on Attributes values and Templates, and the associated Privately Defined UID.

Private SOP Classes shall:

- a. be completely conformant to relevant Parts of the DICOM Standard with the possible exception that support of the DICOM Default Transfer Syntax or a Transfer Syntax mandated by a media storage Application Profile is not required;
- b. not change the PS 3.6 specification of any Standard Attributes;
- c. use a Privately Defined UID for its SOP Class (i.e., shall not be identified with a DICOM Defined UID);
- d. not change existing DIMSE Services or create new ones;
- e. not change existing DICOM File Services defined in PS 3.10 or extend them in a manner which jeopardizes interoperability.

Private SOP Classes may:

- a. use or apply DIMSE Services to privately defined or altered IODs (i.e., not necessarily be based on a Standard SOP Class);
- b. use or apply Media Storage Operations to privately defined or altered IODs (i.e., not necessarily be based on a Standard SOP Class);
- c. designate any Standard Attribute as Type 1, 1C, 2, or 2C regardless of the Type of the Attribute in other IODs;
- d. define Private Attributes as Type 1, 1C, 2, or 2C;
- e. include Private and Standard Type 3 Attributes which may or may not be published in the Conformance Statement.

An implementation claiming conformance with a Private SOP Class shall provide a PS 3.3, PS 3.4, and PS 3.6-like description of the Private SOP Class in the implementation's Conformance Statement, including descriptions of the usage of all Standard and Private Type 1, 1C, 2, or 2C Attributes in the SOP Class, the DICOM Information Model, and the Privately Defined UIDs.

Note: Unpublished SOP Classes (i.e., SOP Classes that are not defined in the DICOM Standard and are not defined in the Conformance Statement) are permitted in order to allow an implementation to support other abstract syntaxes within the DICOM Application Context. Such unpublished SOP Classes would utilize Privately Defined UIDs. The presence of an unpublished SOP Class does not prevent the

implementation from being DICOM conformant but would have no meaning to other implementations and may be ignored.

## **7.4 RULES GOVERNING TYPES OF APPLICATION PROFILES**

Application Profile used in a Conformance Statement shall be of one of three basic types. Each Application Profile in an implementation claiming conformance to the DICOM Standard shall be handled in accordance with the following rules, as dictated by the type of Application Profile.

### **7.4.1 Standard Application Profile**

A Standard Application Profile shall:

- a. conform to all relevant Parts of DICOM with no changes;
- b. support only one of the Physical Media and associated Media Format, as specified by PS 3.12.

To claim conformance to a Standard Application Profile, an implementation shall make a declaration of this fact in its Conformance Statement, and identify its selected options, roles, and behavior.

An implementation of a Standard Application Profile may extend Standard SOP Classes of this Standard application profile. Such Standard Extended SOP Classes shall meet the requirements specified in Section 7.3.

### **7.4.2 Augmented Application Profile**

An Augmented Application Profile shall:

- a. be a proper super set of the Standard Application Profile. It adds the support of additional Standard or Standard Extended SOP Classes;
- b. use the same Physical Media and its associated Media Format specified in the corresponding Standard Application Profile;
- c. not include Specialized or Private SOP Classes.

An Augmented Application Profile may:

- a. include one or more Standard or Standard Extended SOP Classes in addition to those of the corresponding Standard Application Profile. These additional SOP Classes may be mandatory or optional;
- b. include the extensions (e.g. additional required keys, additional directory records) to the Basic Directory Information Object corresponding to the SOP Classes defined in a);
- c. add one or more new roles (FSC, FSR, FSU).

To claim conformance to an Augmented Application Profile, an implementation shall make a declaration of this fact in its Conformance Statement, and shall identify the Standard Application Profile from which it is derived and specify the augmentations. The implementation shall also identify its selected options, roles, and behavior.

An implementation of a Augmented Application Profile may:

- a. extend Standard SOP Classes of the corresponding Standard application profile. Such Standard Extended SOP Classes shall meet the requirements specified in Section 7.3;
- b. also claim conformance to the Standard Application Profile on which this Augmented Profile is based. In this case, FSC and FSU implementations shall be able to restrict their behavior to the Standard Application Profile (i.e., provide a means to write only the Standard or Standard Extended SOP Classes defined in the corresponding Standard Application Profile).

### **7.4.3 Private Application Profile**

A Private Application Profile:

- conforms to PS 3.10 and to the Media Storage Service Class specified in PS 3.4;
- support only one of the Physical Media and associated Media Format, as specified by PS 3.12;

Note: The intent of these two conditions is to ensure that at least the DICOMDIR is readable by other APs.

- complies with the rules governing SOP Classes in section 7.3.

To claim conformance to a Private Application Profile, an implementation shall make a declaration of this fact in its Conformance Statement, and shall provide a description of the Application Profile patterned after the descriptions in PS 3.11. The implementation shall also identify its selected options, roles, and behavior.

Note: An implementation that does not meet the provisions of Section 7, including the types of Application Profile, is not conformant to DICOM and so is outside the scope of DICOM conformance. Such an implementation is not an Application Profile in DICOM terminology. For example, if an implementation chooses to write DICOM files onto media that is not in PS 3.12, or use a file system not defined for a specific media type in PS 3.12, then that implementation cannot claim that it conforms to the DICOM Standard using that media or file system.

## 7.5 CONFORMANCE OF DICOM MEDIA

DICOM does not define conformance of a piece of medium in a generic sense. DICOM conformance of a piece of medium can only be evaluated within the scope of one or more media storage Application Profiles which define specific contexts for interoperability.

Note: One may accept the statement “this is a DICOM CD-R” when pointing to a storage medium. However, one should not state “this CD-R is DICOM conformant”, but rather “this CD-R conforms to the Basic Cardiac X-ray Angiographic DICOM Application Profile”.

## 7.6 SECURITY PROFILES

DICOM specifies methods for providing security at different levels of the ISO OSI Basic Reference Model through the use of mechanisms specific to a particular layer. The methods for applying these mechanisms are described in the various parts of the DICOM Standard. Some mechanisms and algorithms are specified in PS 3.15 as Security Profiles. An implementation’s Conformance Statement describes which Security Profiles can be used by that application.

Note: For example, the Basic TLS Secure Transport Connection Profile defines a mechanism for authenticating entities participating in the exchange of data, and for protecting the integrity and confidentiality of information during interchange.

An implementation shall list in its Conformance Statement any Security Profiles that it supports, how it selects which Security Profiles it uses, and how it uses features of that Security Profile.

An implementation shall list in its Conformance Statement any additional use of the User Identity association negotiation sub-item that is not specified in a standard Security Profile.

## **ANNEX A (Normative) DICOM CONFORMANCE STATEMENT TEMPLATE**

This Annex is a template which shall be used to generate a DICOM Conformance Statement. The document is hierarchically structured in three different levels:

- A DICOM Conformance Statement Overview, which is typically one page, geared towards people that want to get a quick overview of the functionality and services.
- For Networking and Media, the relationship between the AE's, followed by the information for each AE
- For the services supported as SCU and SCP all the SOP specific details

Annexes are provided to specify the Object descriptions (IOD's), with specifics about the field usage as well as the data dictionaries.

Note: The numbering scheme for numbering paragraphs in this document is to be used as a guideline in preparing the outline of the Conformance Statement. Although strongly encouraged, the Conformance Statement is not required to have exactly the same paragraph numbers because a particular Conformance Statement might have special considerations, which will cause the outline to differ in certain details from the outline of this document. In addition, a vendor might have internal company guidelines prescribing a specific format. Note however, that the overall structure, tables, definition of variables and information such as headers, should be strictly followed.

## **A.0 COVER PAGE**

A DICOM Conformance Statement may have a cover page, which, if present, shall include:

- a. The commercial name and version(s) of the concerned product or products (if applicable to several products) including all optional features. The product version shall correspond to the functionality as described in this conformance statement.
- b. Date of the document

### A.1 CONFORMANCE STATEMENT OVERVIEW

The Overview consist of typically 5-10 lines describing the network services and media storage capabilities supported by the product in layman's terms (i.e. no DICOM acronyms should be used).

A table of Supported Networking DICOM Service (SOP) Classes is provided with roles (User/Provider), organized in 4 categories:

- Transfer
- Query/Retrieve
- Workflow Management
- Print Management

The first column shall specify the SOP Classes exactly as named in PS 3.6., Registry of DICOM Unique Identifiers. The phrase "and specializations" may be added to indicate support of all specializations negotiated through the SOP Class Common Extended Negotiation. If the implementation supports all SOP Classes of a particular Service Class through SOP Class Common Extended Negotiation, the first column shall specify "All services of the <x> Service Class".

**Table A.1-1  
NETWORK SERVICES**

| SOP Classes                                  | User of Service (SCU) | Provider of Service (SCP) |
|----------------------------------------------|-----------------------|---------------------------|
| <b>Transfer</b>                              |                       |                           |
| CT Image Storage                             | Yes                   | No                        |
| US Image Storage                             | Yes                   | Yes                       |
| <b>Query/Retrieve</b>                        |                       |                           |
| Patient Root Information Model FIND          | Option                | No                        |
| <b>Notes, Reports, Measurements Transfer</b> |                       |                           |
| Comprehensive SR, and specializations        | No                    | Yes                       |
| .....                                        |                       |                           |

The services can be specified as a SCU, SCP or as an Option, which means that it is either configurable or that it can be purchased separately.

Note: Verification SCP (C-Echo) is not included in the table above because it is required for any Acceptor of an Association. The Verification SCU details are covered in the details of the conformance statement.

The SOP Classes are categorized as follows:

**Table A.1-2  
UID VALUES**

| <b>UID Value</b>            | <b>UID NAME</b>                                          | <b>Category</b>     |
|-----------------------------|----------------------------------------------------------|---------------------|
| 1.2.840.10008.1.20.1        | Storage Commitment Push Model SOP Class                  | Workflow Management |
| 1.2.840.10008.1.40          | Procedural Event Logging SOP Class                       | Workflow Management |
| 1.2.840.10008.1.42          | Substance Administration Logging                         | Workflow Management |
| 1.2.840.10008.3.1.2.3.3     | Modality Performed Procedure Step SOP Class              | Workflow Management |
| 1.2.840.10008.3.1.2.3.4     | Modality Performed Procedure Step Retrieve SOP Class     | Workflow Management |
| 1.2.840.10008.3.1.2.3.5     | Modality Performed Procedure Step Notification SOP Class | Workflow Management |
| 1.2.840.10008.4.2           | Storage Service Class                                    | Transfer            |
| 1.2.840.10008.5.1.1.1       | Basic Film Session SOP Class                             | Print Management    |
| 1.2.840.10008.5.1.1.2       | Basic Film Box SOP Class                                 | Print Management    |
| 1.2.840.10008.5.1.1.4       | Basic Grayscale Image Box SOP Class                      | Print Management    |
| 1.2.840.10008.5.1.1.4.1     | Basic Color Image Box SOP Class                          | Print Management    |
| 1.2.840.10008.5.1.1.9       | Basic Grayscale Print Management Meta SOP Class          | Print Management    |
| 1.2.840.10008.5.1.1.14      | Print Job SOP Class                                      | Print Management    |
| 1.2.840.10008.5.1.1.15      | Basic Annotation Box SOP Class                           | Print Management    |
| 1.2.840.10008.5.1.1.16      | Printer SOP Class                                        | Print Management    |
| 1.2.840.10008.5.1.1.16.376  | Printer Configuration Retrieval SOP Class                | Print Management    |
| 1.2.840.10008.5.1.1.18      | Basic Color Print Management Meta SOP Class              | Print Management    |
| 1.2.840.10008.5.1.1.23      | Presentation LUT SOP Class                               | Print Management    |
| 1.2.840.10008.5.1.1.24.1    | Basic Print Image Overlay Box SOP Class                  | Print Management    |
| 1.2.840.10008.5.1.1.33      | Media Creation Management SOP Class UID                  | Print Management    |
| 1.2.840.10008.5.1.4.1.1.1   | Computed Radiography Image Storage                       | Transfer            |
| 1.2.840.10008.5.1.4.1.1.1.1 | Digital X-Ray Image Storage – For                        | Transfer            |

|                               | Presentation                                               |          |
|-------------------------------|------------------------------------------------------------|----------|
| 1.2.840.10008.5.1.4.1.1.1.1.1 | Digital X-Ray Image Storage – For Processing               | Transfer |
| 1.2.840.10008.5.1.4.1.1.1.2   | Digital Mammography X-Ray Image Storage – For Presentation | Transfer |
| 1.2.840.10008.5.1.4.1.1.1.2.1 | Digital Mammography X-Ray Image Storage – For Processing   | Transfer |
| 1.2.840.10008.5.1.4.1.1.1.3   | Digital Intra-oral X-Ray Image Storage – For Presentation  | Transfer |
| 1.2.840.10008.5.1.4.1.1.1.3.1 | Digital Intra-oral X-Ray Image Storage – For Processing    | Transfer |
| 1.2.840.10008.5.1.4.1.1.2     | CT Image Storage                                           | Transfer |
| 1.2.840.10008.5.1.4.1.1.2.1   | Enhanced CT Image Storage                                  | Transfer |
| 1.2.840.10008.5.1.4.1.1.3.1   | Ultrasound Multi-frame Image Storage                       | Transfer |
| 1.2.840.10008.5.1.4.1.1.4     | MR Image Storage                                           | Transfer |
| 1.2.840.10008.5.1.4.1.1.4.1   | Enhanced MR Image Storage                                  | Transfer |
| 1.2.840.10008.5.1.4.1.1.4.2   | MR Spectroscopy Storage                                    | Transfer |
| 1.2.840.10008.5.1.4.1.1.6.1   | Ultrasound Image Storage                                   | Transfer |
| 1.2.840.10008.5.1.4.1.1.7     | Secondary Capture Image Storage                            | Transfer |
| 1.2.840.10008.5.1.4.1.1.7.1   | Multi-frame Single Bit Secondary Capture Image Storage     | Transfer |
| 1.2.840.10008.5.1.4.1.1.7.2   | Multi-frame Grayscale Byte Secondary Capture Image Storage | Transfer |
| 1.2.840.10008.5.1.4.1.1.7.3   | Multi-frame Grayscale Word Secondary Capture Image Storage | Transfer |
| 1.2.840.10008.5.1.4.1.1.7.4   | Multi-frame True Color Secondary Capture Image Storage     | Transfer |
| 1.2.840.10008.5.1.4.1.1.9.1.1 | 12-lead ECG Waveform Storage                               | Transfer |
| 1.2.840.10008.5.1.4.1.1.9.1.2 | General ECG Waveform Storage                               | Transfer |
| 1.2.840.10008.5.1.4.1.1.9.1.3 | Ambulatory ECG Waveform Storage                            | Transfer |
| 1.2.840.10008.5.1.4.1.1.9.2.1 | Hemodynamic Waveform Storage                               | Transfer |
| 1.2.840.10008.5.1.4.1.1.9.3.1 | Cardiac Electrophysiology                                  | Transfer |



|                                  |                                                            |          |
|----------------------------------|------------------------------------------------------------|----------|
|                                  | Waveform Storage                                           |          |
| 1.2.840.10008.5.1.4.1.1.9.4.1    | Basic Voice Audio Waveform Storage                         | Transfer |
| 1.2.840.10008.5.1.4.1.1.11.1     | Grayscale Softcopy Presentation State Storage SOP Class    | Transfer |
| 1.2.840.10008.5.1.4.1.1.11.2     | Color Softcopy Presentation State Storage SOP Class        | Transfer |
| 1.2.840.10008.5.1.4.1.1.11.3     | Pseudo-Color Softcopy Presentation State Storage SOP Class | Transfer |
| 1.2.840.10008.5.1.4.1.1.11.4     | Blending Softcopy Presentation State Storage SOP Class     | Transfer |
| 1.2.840.10008.5.1.4.1.1.12.1     | X-Ray Angiographic Image Storage                           | Transfer |
| 1.2.840.10008.5.1.4.1.1.12.1.1   | Enhanced XA Image Storage                                  | Transfer |
| 1.2.840.10008.5.1.4.1.1.12.2     | X-Ray Radiofluoroscopic Image Storage                      | Transfer |
| 1.2.840.10008.5.1.4.1.1.12.2.1   | Enhanced XRF Image Storage                                 | Transfer |
| 1.2.840.10008.5.1.4.1.1.13.1.1   | X-Ray 3D Angiographic Image Storage                        | Transfer |
| 1.2.840.10008.5.1.4.1.1.13.1.2   | X-Ray 3D Craniofacial Image Storage                        | Transfer |
| 1.2.840.10008.5.1.4.1.1.20       | Nuclear Medicine Image Storage                             | Transfer |
| 1.2.840.10008.5.1.4.1.1.66       | Raw Data Storage                                           | Transfer |
| 1.2.840.10008.5.1.4.1.1.66.1     | Spatial Registration Storage                               | Transfer |
| 1.2.840.10008.5.1.4.1.1.66.2     | Spatial Fiducials Storage                                  | Transfer |
| 1.2.840.10008.5.1.4.1.1.66.3     | Deformable Spatial Registration SOP Class                  | Transfer |
| 1.2.840.10008.5.1.4.1.1.66.4     | Segmentation SOP Class                                     | Transfer |
| 1.2.840.10008.5.1.4.1.1.67       | Real World Value Mapping Storage                           | Transfer |
| 1.2.840.10008.5.1.4.1.1.77.1.1   | VL Endoscopic Image Storage                                | Transfer |
| 1.2.840.10008.5.1.4.1.1.77.1.1.1 | Video Endoscopic Image Storage                             | Transfer |
| 1.2.840.10008.5.1.4.1.1.77.1.2   | VL Microscopic Image Storage                               | Transfer |
| 1.2.840.10008.5.1.4.1.1.77.1.2.1 | Video Microscopic Image Storage                            | Transfer |
| 1.2.840.10008.5.1.4.1.1.77.1.3   | VL Slide-Coordinates Microscopic Image                     | Transfer |

|                                  | Storage                                              |                |
|----------------------------------|------------------------------------------------------|----------------|
| 1.2.840.10008.5.1.4.1.1.77.1.4   | VL Photographic Image Storage                        | Transfer       |
| 1.2.840.10008.5.1.4.1.1.77.1.4.1 | Video Photographic Image Storage                     | Transfer       |
| 1.2.840.10008.5.1.4.1.1.77.1.4.1 | Video Photographic Image Storage                     | Transfer       |
| 1.2.840.10008.5.1.4.1.1.77.1.5.1 | Ophthalmic Photography 8 Bit Image Storage           | Transfer       |
| 1.2.840.10008.5.1.4.1.1.77.1.5.2 | Ophthalmic Photography 16 Bit Image Storage          | Transfer       |
| 1.2.840.10008.5.1.4.1.1.77.1.5.3 | Stereometric Relationship Storage                    | Transfer       |
| 1.2.840.10008.5.1.4.1.1.77.1.5.4 | Ophthalmic Tomography Image Storage                  | Transfer       |
| 1.2.840.10008.5.1.4.1.1.88.11    | Basic Text SR                                        | Transfer       |
| 1.2.840.10008.5.1.4.1.1.88.22    | Enhanced SR                                          | Transfer       |
| 1.2.840.10008.5.1.4.1.1.88.33    | Comprehensive SR                                     | Transfer       |
| 1.2.840.10008.5.1.4.1.1.88.40    | Procedure Log Storage                                | Transfer       |
| 1.2.840.10008.5.1.4.1.1.88.50    | Mammography CAD SR                                   | Transfer       |
| 1.2.840.10008.5.1.4.1.1.88.59    | Key Object Selection Document                        | Transfer       |
| 1.2.840.10008.5.1.4.1.1.88.65    | Chest CAD SR                                         | Transfer       |
| 1.2.840.10008.5.1.4.1.1.88.67    | X-Ray Radiation Dose SR                              | Transfer       |
| 1.2.840.10008.5.1.4.1.1.104.1    | Encapsulated PDF Storage SOP Class                   | Transfer       |
| 1.2.840.10008.5.1.4.1.1.104.2    | Encapsulated CDA Storage SOP Class                   | Transfer       |
| 1.2.840.10008.5.1.4.1.1.128      | Positron Emission Tomography Image Storage           | Transfer       |
| 1.2.840.10008.5.1.4.1.1.481.1    | RT Image Storage                                     | Transfer       |
| 1.2.840.10008.5.1.4.1.1.481.2    | RT Dose Storage                                      | Transfer       |
| 1.2.840.10008.5.1.4.1.1.481.3    | RT Structure Set Storage                             | Transfer       |
| 1.2.840.10008.5.1.4.1.1.481.4    | RT Beams Treatment Record Storage                    | Transfer       |
| 1.2.840.10008.5.1.4.1.1.481.5    | RT Plan Storage                                      | Transfer       |
| 1.2.840.10008.5.1.4.1.1.481.6    | RT Brachy Treatment Record Storage                   | Transfer       |
| 1.2.840.10008.5.1.4.1.1.481.7    | RT Treatment Summary Record Storage                  | Transfer       |
| 1.2.840.10008.5.1.4.1.2.1.1      | Patient Root Query/Retrieve Information Model – FIND | Query/Retrieve |
| 1.2.840.10008.5.1.4.1.2.1.2      | Patient Root Query/Retrieve                          | Query/Retrieve |

|                             |                                                             |                     |
|-----------------------------|-------------------------------------------------------------|---------------------|
|                             | Information Model –<br>MOVE                                 |                     |
| 1.2.840.10008.5.1.4.1.2.1.3 | Patient Root<br>Query/Retrieve<br>Information Model – GET   | Query/Retrieve      |
| 1.2.840.10008.5.1.4.1.2.2.1 | Study Root<br>Query/Retrieve<br>Information Model – FIND    | Query/Retrieve      |
| 1.2.840.10008.5.1.4.1.2.2.2 | Study Root<br>Query/Retrieve<br>Information Model –<br>MOVE | Query/Retrieve      |
| 1.2.840.10008.5.1.4.1.2.2.3 | Study Root<br>Query/Retrieve<br>Information Model – GET     | Query/Retrieve      |
| 1.2.840.10008.5.1.4.31      | Modality Worklist<br>Information Model – FIND               | Workflow Management |
| 1.2.840.10008.5.1.4.32.1    | General Purpose Worklist<br>Information Model – FIND        | Workflow Management |
| 1.2.840.10008.5.1.4.32.2    | General Purpose<br>Scheduled Procedure<br>Step SOP Class    | Workflow Management |
| 1.2.840.10008.5.1.4.32.3    | General Purpose<br>Performed Procedure<br>Step SOP Class    | Workflow Management |
| 1.2.840.10008.5.1.4.32      | General Purpose Worklist<br>Management Meta SOP<br>Class    | Workflow Management |
| 1.2.840.10008.5.1.4.33      | Instance Availability<br>Notification SOP Class             | Workflow Management |
| 1.2.840.10008.5.1.4.37.1    | General Relevant Patient<br>Information Query               | Query/Retrieve      |
| 1.2.840.10008.5.1.4.37.2    | Breast Imaging Relevant<br>Patient Information Query        | Query/Retrieve      |
| 1.2.840.10008.5.1.4.37.3    | Cardiac Relevant Patient<br>Information Query               | Query/Retrieve      |
| 1.2.840.10008.5.1.4.38.1    | Hanging Protocol Storage                                    | Transfer            |
| 1.2.840.10008.5.1.4.38.2    | Hanging Protocol<br>Information Model – FIND                | Query/Retrieve      |
| 1.2.840.10008.5.1.4.38.3    | Hanging Protocol<br>Information Model –<br>MOVE             | Query/Retrieve      |
| 1.2.840.10008.5.1.4.41      | Product Characteristics<br>Query                            | Query/Retrieve      |
| 1.2.840.10008.5.1.4.42      | Substance Approval<br>Query                                 | Query/Retrieve      |

A table of Supported Media Storage Application Profiles (with roles) is provided, organized in 3 categories:

- Compact Disk - Recordable
- Magneto-Optical Disk
- DVD

**Table A.1-3  
MEDIA SERVICES**

| <b>Media Storage Application Profile</b> | <b>Write Files (FSC or FSU)</b> | <b>Read Files (FSR)</b> |
|------------------------------------------|---------------------------------|-------------------------|
| <b>Compact Disk - Recordable</b>         |                                 |                         |
| General Purpose CD-R                     | Option                          | Yes                     |
| <b>Magneto-Optical Disk</b>              |                                 |                         |
| CT/MR 2.3 GB MOD                         | Yes                             | Yes                     |
| <b>DVD</b>                               |                                 |                         |
| General Purpose DVD-RAM                  | Yes                             | Yes                     |

## **A.2 TABLE OF CONTENTS**

The table of contents will be provided to assist readers in easily finding the needed information.

### A.3 INTRODUCTION

The introduction specifies product and relevant disclaimers as well as any general information that the vendor feels is appropriate.

The following subsections are suggested:

#### A.3.1 REVISION HISTORY

The revision history provides dates and differences of the different releases of the product and the Conformance Statement.

#### A.3.2 AUDIENCE

The audience is specified with their assumed pre-knowledge. The following example may be used as a template:

This document is written for the people that need to understand how <Product Name> will integrate into their healthcare facility. This includes both those responsible for overall imaging network policy and architecture, as well as integrators who need to have a detailed understanding of the DICOM features of the product. This document contains some basic DICOM definitions so that any reader may understand how this product implements DICOM features. However, integrators are expected to fully understand all the DICOM terminology, how the tables in this document relate to the product's functionality, and how that functionality integrates with other devices that support compatible DICOM features.

#### A.3.3 REMARKS

Any important remarks, disclaimers, and general information are specified. The following example may be used as a template:

The scope of this DICOM Conformance Statement is to facilitate integration between <Product Name> and other DICOM products. The Conformance Statement should be read and understood in conjunction with the DICOM Standard. DICOM by itself does not guarantee interoperability. The Conformance Statement does, however, facilitate a first-level comparison for interoperability between different applications supporting compatible DICOM functionality.

This Conformance Statement is not supposed to replace validation with other DICOM equipment to ensure proper exchange of intended information. In fact, the user should be aware of the following important issues:

- The comparison of different Conformance Statements is just the first step towards assessing interconnectivity and interoperability between the product and other DICOM conformant equipment.
- Test procedures should be defined and executed to validate the required level of interoperability with specific compatible DICOM equipment, as established by the healthcare facility.

If the product has an IHE Intergration Statement, the following statement may be applicable:

<Product Name> has participated in an industry-wide testing program sponsored by Integrating the Healthcare Enterprise (IHE). The IHE Integration Statement for <Product Name>, together with the IHE Technical Framework, may facilitate the process of validation testing.

### A.3.4 TERMS AND DEFINITIONS

Terms and definitions should be listed here. The following example may be used as a template:

Informal definitions are provided for the following terms used in this Conformance Statement. The DICOM Standard is the authoritative source for formal definitions of these terms.

**Abstract Syntax** – the information agreed to be exchanged between applications, generally equivalent to a Service/Object Pair (SOP) Class. Examples : Verification SOP Class, Modality Worklist Information Model Find SOP Class, Computed Radiography Image Storage SOP Class.

**Application Entity (AE)** – an end point of a DICOM information exchange, including the DICOM network or media interface software; i.e., the software that sends or receives DICOM information objects or messages. A single device may have multiple Application Entities.

**Application Entity Title** – the externally known name of an *Application Entity*, used to identify a DICOM application to other DICOM applications on the network.

**Application Context** – the specification of the type of communication used between *Application Entities*. Example: DICOM network protocol.

**Association** – a network communication channel set up between *Application Entities*.

**Attribute** – a unit of information in an object definition; a data element identified by a *tag*. The information may be a complex data structure (Sequence), itself composed of lower level data elements. Examples: Patient ID (0010,0020), Accession Number (0008,0050), Photometric Interpretation (0028,0004), Procedure Code Sequence (0008,1032).

**Information Object Definition (IOD)** – the specified set of *Attributes* that comprise a type of data object; does not represent a specific instance of the data object, but rather a class of similar data objects that have the same properties. The *Attributes* may be specified as Mandatory (Type 1), Required but possibly unknown (Type 2), or Optional (Type 3), and there may be conditions associated with the use of an Attribute (Types 1C and 2C). Examples: MR Image IOD, CT Image IOD, Print Job IOD.

**Joint Photographic Experts Group (JPEG)** – a set of standardized image compression techniques, available for use by DICOM applications.

**Media Application Profile** – the specification of DICOM information objects and encoding exchanged on removable media (e.g., CDs)

**Module** – a set of *Attributes* within an *Information Object Definition* that are logically related to each other. Example: Patient Module includes Patient Name, Patient ID, Patient Birth Date, and Patient Sex.

**Negotiation** – first phase of *Association* establishment that allows *Application Entities* to agree on the types of data to be exchanged and how that data will be encoded.

**Presentation Context** – the set of DICOM network services used over an *Association*, as negotiated between *Application Entities*; includes *Abstract Syntaxes* and *Transfer Syntaxes*.

**Protocol Data Unit (PDU)** – a packet (piece) of a DICOM message sent across the network. Devices must specify the maximum size packet they can receive for DICOM messages.

**Security Profile** – a set of mechanisms, such as encryption, user authentication, or digital signatures, used by an *Application Entity* to ensure confidentiality, integrity, and/or availability of exchanged DICOM data

**Service Class Provider (SCP)** – role of an *Application Entity* that provides a DICOM network service; typically, a server that performs operations requested by another *Application Entity*

(*Service Class User*). Examples: Picture Archiving and Communication System (image storage SCP, and image query/retrieve SCP), Radiology Information System (modality worklist SCP).

**Service Class User (SCU)** – role of an *Application Entity* that uses a DICOM network service; typically, a client. Examples: imaging modality (image storage SCU, and modality worklist SCU), imaging workstation (image query/retrieve SCU)

**Service/Object Pair (SOP) Class** – the specification of the network or media transfer (service) of a particular type of data (object); the fundamental unit of DICOM interoperability specification. Examples: Ultrasound Image Storage Service, Basic Grayscale Print Management.

**Service/Object Pair (SOP) Instance** – an information object; a specific occurrence of information exchanged in a *SOP Class*. Examples: a specific x-ray image.

**Tag** – a 32-bit identifier for a data element, represented as a pair of four digit hexadecimal numbers, the “group” and the “element”. If the “group” number is odd, the tag is for a private (manufacturer-specific) data element. Examples: (0010,0020) [Patient ID], (07FE,0010) [Pixel Data], (0019,0210) [private data element]

**Transfer Syntax** – the encoding used for exchange of DICOM information objects and messages. Examples: *JPEG* compressed (images), little endian explicit value representation.

**Unique Identifier (UID)** – a globally unique “dotted decimal” string that identifies a specific object or a class of objects; an ISO-8824 Object Identifier. Examples: Study Instance UID, SOP Class UID, SOP Instance UID.

**Value Representation (VR)** – the format type of an individual DICOM data element, such as text, an integer, a person’s name, or a code. DICOM information objects can be transmitted with either explicit identification of the type of each data element (Explicit VR), or without explicit identification (Implicit VR); with Implicit VR, the receiving application must use a DICOM data dictionary to look up the format of each data element.

### A.3.5 BASICS OF DICOM COMMUNICATION

A layman’s introduction to DICOM may be included here. The following example may be used as a template:

This section describes terminology used in this Conformance Statement for the non-specialist. The key terms used in the Conformance Statement are highlighted in *italics* below. This section is not a substitute for training about DICOM, and it makes many simplifications about the meanings of DICOM terms.

Two *Application Entities* (devices) that want to communicate with each other over a network using DICOM protocol must first agree on several things during an initial network “handshake”. One of the two devices must initiate an *Association* (a connection to the other device), and ask if specific services, information, and encoding can be supported by the other device (*Negotiation*).

DICOM specifies a number of network services and types of information objects, each of which is called an *Abstract Syntax* for the Negotiation. DICOM also specifies a variety of methods for encoding data, denoted *Transfer Syntaxes*. The Negotiation allows the initiating Application Entity to propose combinations of Abstract Syntax and Transfer Syntax to be used on the Association; these combinations are called *Presentation Contexts*. The receiving Application Entity accepts the Presentation Contexts it supports.

For each Presentation Context, the Association Negotiation also allows the devices to agree on *Roles* – which one is the *Service Class User* (SCU - client) and which is the *Service Class Provider* (SCP - server). Normally the device initiating the connection is the SCU, i.e., the client system calls the server, but not always.



The Association Negotiation finally enables exchange of maximum network packet (*PDU*) size, security information, and network service options (called *Extended Negotiation* information).

The Application Entities, having negotiated the Association parameters, may now commence exchanging data. Common data exchanges include queries for worklists and lists of stored images, transfer of image objects and analyses (structured reports), and sending images to film printers. Each exchangeable unit of data is formatted by the sender in accordance with the appropriate *Information Object Definition*, and sent using the negotiated Transfer Syntax. There is a Default Transfer Syntax that all systems must accept, but it may not be the most efficient for some use cases. Each transfer is explicitly acknowledged by the receiver with a *Response Status* indicating success, failure, or that query or retrieve operations are still in process.

Two Application Entities may also communicate with each other by exchanging media (such as a CD-R). Since there is no Association Negotiation possible, they both use a *Media Application Profile* that specifies “pre-negotiated” exchange media format, Abstract Syntax, and Transfer Syntax.

### A.3.6 ABBREVIATIONS

Abbreviations should be listed here. These may be taken from the following list, deleting terms that are not used within the Conformance Statement, and adding any additional terms that are used:

|       |                                                |
|-------|------------------------------------------------|
| AE    | Application Entity                             |
| AET   | Application Entity Title                       |
| CAD   | Computer Aided Detection                       |
| CDA   | Clinical Document Architecture                 |
| CD-R  | Compact Disk Recordable                        |
| CSE   | Customer Service Engineer                      |
| CR    | Computed Radiography                           |
| CT    | Computed Tomography                            |
| DHCP  | Dynamic Host Configuration Protocol            |
| DICOM | Digital Imaging and Communications in Medicine |
| DIT   | Directory Information Tree (LDAP)              |
| DN    | Distinguished Name (LDAP)                      |
| DNS   | Domain Name System                             |
| DX    | Digital X-ray                                  |
| FSC   | File-Set Creator                               |
| FSU   | File-Set Updater                               |
| FSR   | File-Set Reader                                |
| GSDF  | Grayscale Standard Display Function            |
| GSPS  | Grayscale Softcopy Presentation State          |
| HIS   | Hospital Information System                    |
| HL7   | Health Level 7 Standard                        |
| IHE   | Integrating the Healthcare Enterprise          |
| IOD   | Information Object Definition                  |

|                            |                                                 |
|----------------------------|-------------------------------------------------|
| IPv4                       | Internet Protocol version 4                     |
| IPv6                       | Internet Protocol version 6                     |
| ISO                        | International Organization for Standards        |
| IO                         | Intra-oral X-ray                                |
| JPEG                       | Joint Photographic Experts Group                |
| LDAP                       | Lightweight Directory Access Protocol           |
| LDIF                       | LDAP Data Interchange Format                    |
| LUT                        | Look-up Table                                   |
| MAR                        | Medication Administration Record                |
| MPEG                       | Moving Picture Experts Group                    |
| MG                         | Mammography (X-ray)                             |
| MPPS                       | Modality Performed Procedure Step               |
| MR                         | Magnetic Resonance Imaging                      |
| MSPS                       | Modality Scheduled Procedure Step               |
| MTU                        | Maximum Transmission Unit (IP)                  |
| MWL                        | Modality Worklist                               |
| NM                         | Nuclear Medicine                                |
| NTP                        | Network Time Protocol                           |
| O Optional (Key Attribute) |                                                 |
| OP                         | Ophthalmic Photography                          |
| OSI                        | Open Systems Interconnection                    |
| PACS                       | Picture Archiving and Communication System      |
| PET                        | Positron Emission Tomography                    |
| PDU                        | Protocol Data Unit                              |
| R Required (Key Attribute) |                                                 |
| RDN                        | Relative Distinguished Name (LDAP)              |
| RF                         | Radiofluoroscopy                                |
| RIS                        | Radiology Information System.                   |
| RT                         | Radiotherapy                                    |
| SC                         | Secondary Capture                               |
| SCP                        | Service Class Provider                          |
| SCU                        | Service Class User                              |
| SOP                        | Service-Object Pair                             |
| SPS                        | Scheduled Procedure Step                        |
| SR                         | Structured Reporting                            |
| TCP/IP                     | Transmission Control Protocol/Internet Protocol |
| U Unique (Key Attribute)   |                                                 |
| UL                         | Upper Layer                                     |

|    |                      |
|----|----------------------|
| US | Ultrasound           |
| VL | Visible Light        |
| VR | Value Representation |
| XA | X-ray Angiography    |

### A.3.7 REFERENCES

Referenced documents should be listed here, including appropriate product manuals (such as service manuals that specify how to set DICOM communication parameters). References to the DICOM Standard should provide the URL for the free published version of the Standard, but should not specify a date of publication:

|          |                                                                                                                                                    |
|----------|----------------------------------------------------------------------------------------------------------------------------------------------------|
| NEMA PS3 | Digital Imaging and Communications in Medicine (DICOM) Standard, available free at <a href="http://medical.nema.org/">http://medical.nema.org/</a> |
|----------|----------------------------------------------------------------------------------------------------------------------------------------------------|

## A.4 NETWORKING

This section contains the networking related services (vs. the media related ones).

### A.4.1 IMPLEMENTATION MODEL

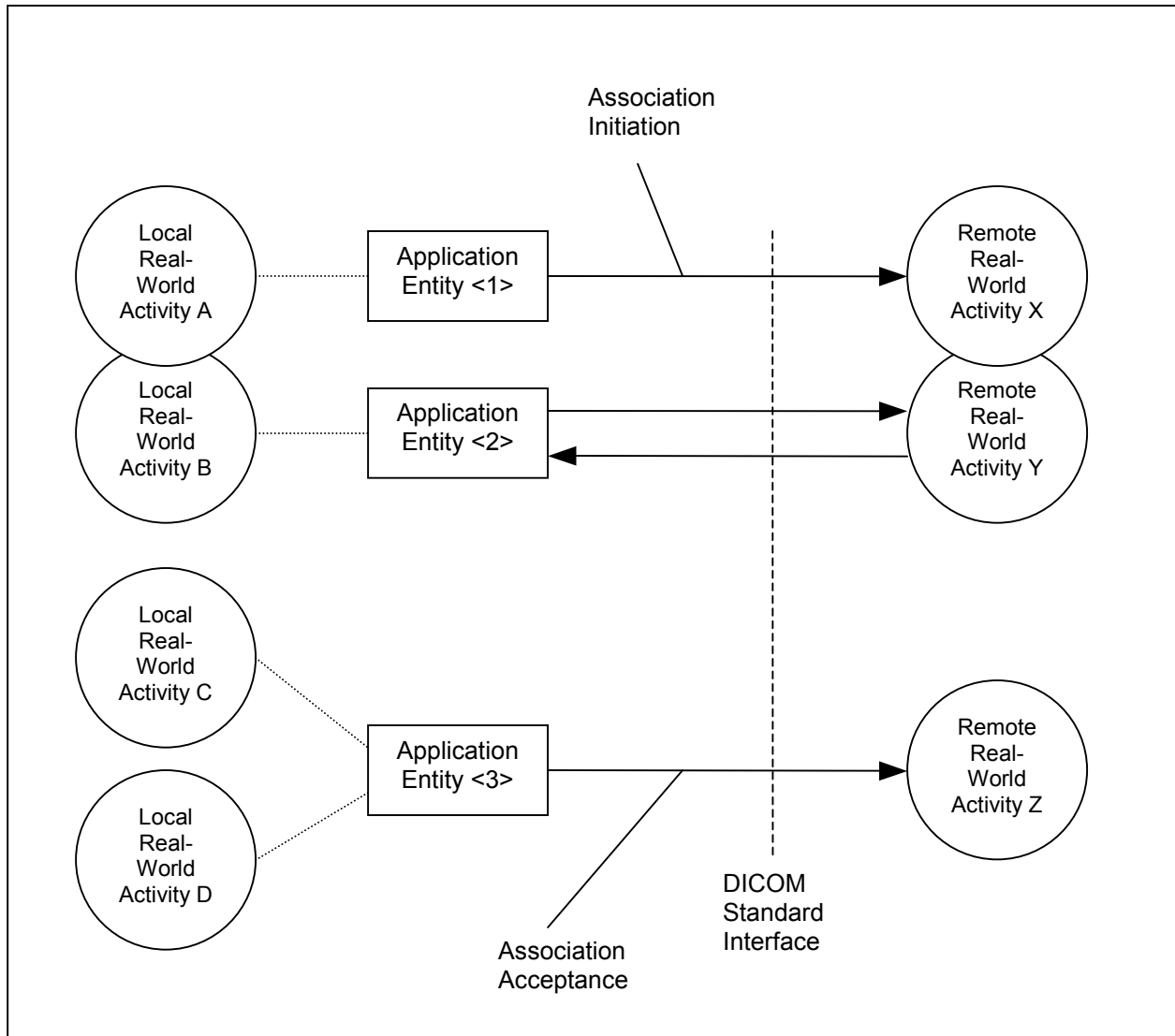
The Implementation model consists of three sections: the Application Data Flow Diagram, specifying the relationship between the Application Entities and the “external world” or Real-World activities, a functional description of each Application Entity, and the sequencing constraints among them.

#### A.4.1.1 Application Data Flow

As part of the Implementation model, an Application Data Flow Diagram shall be included. This diagram represents all of the Application Entities present in an implementation, and graphically depicts the relationship of the AE's use of DICOM to Real-World Activities as well as any applicable User interaction. Figure A.4.1-1 is a template for such a Data Flow Diagram.

In this illustration, according to figure A.4.1 -1, an occurrence of local Real-World Activity A will cause local Application Entity <1> to initiate an association for the purpose of causing Real-World Activity X to occur remotely. It also shows that Real-World Activities B and Y are interactively related via Application Entity <2>, with B being local and Y Remote, and that local Application Entity 3 expects to receive an association request when remote Real-World Activity Z occurs so that it can perform Real-World Activity C and/or D. When the performance of Real-World activities relies on interactions within the implementation, one may depict the circles as overlapping as shown in Figure A.4.1 -1. Any such overlap shall be discussed in this section of a Conformance Statement.

Typically, there is a one to one relationship between an AE and an AE Title. Devices may be capable of configuring the relationship between AE and AE Title (e.g. by merging Application Entities to use a single AE Title). This is specified in the configuration section.



**Figure A.4.1 -1  
FUNCTIONAL OVERVIEW**

The Application Data Flow Diagram shall contain overview text with one bullet per AE. Each bullet should provide an overview of each one of the AE's, in relationship to their real-world activities, AE network exchanges and external real-world activities.

Note: There is no standard definition or guidelines on the number of AE's within a product and what an AE should encompass. Its functionality and scope is purely to the discretion of the vendor and typically depending on the system architecture.

#### **A.4.1.2 Functional Definition of AE's**

This part shall contain a functional definition for each individual local Application Entity. This shall describe in general terms the functions to be performed by the AE, and the DICOM services used to accomplish these functions. In this sense, "DICOM services" refers not only to DICOM Service Classes, but also to lower level DICOM services, such as Association Services.

**A.4.1.2.1 Functional Definition of “Application Entity <1>”**

Functional description of “Application Entity <1>” (substitute actual AE name), i.e. what is it that the AE performs.

**A.4.1.2.2 Functional Definition of “Application Entity <2>”**

Same for “Application Entity <2>”.

**A.4.1.2.3 Functional Definition of “Application Entity <3>”**

Same for “Application Entity <3>”.

**A.4.1.3 Sequencing of Real World Activities**

If applicable, this section shall contain a description of sequencing as well as potential constraints, of Real-World Activities, including any applicable user interactions, as performed by all the Application Entities. A UML sequence diagram, which depicts the Real-World Activities as vertical bars and shows the events exchanged between them as arrows, is strongly recommended.

**A.4.2 AE SPECIFICATIONS:**

The next section in the DICOM Conformance Statement is a set of Application Entity Specifications. There shall be one such specification for each Application Entity. Each individual AE Specification has a subsection, A.4.2.x. There are as many of these subsections as there are different AE's in the implementation. That is, if there are two distinct AE's, then there will be two subsections, A.4.2.1, and A.4.2.2.

**A.4.2.1 “Application Entity <1>”**

Every detail of this specific Application Entity shall be completely specified under this section.

**A.4.2.1.1 SOP Classes**

The specification for an Application Entity shall contain a statement of the form:

"This Application Entity provides Standard Conformance to the following SOP Class(es):"

**Table A.4.2-1  
SOP CLASS(ES) FOR “APPLICATION ENTITY <1>”**

| SOP Class Name                                                                                                                                      | SOP Class UID              | SCU    | SCP    |
|-----------------------------------------------------------------------------------------------------------------------------------------------------|----------------------------|--------|--------|
| SOP Class UID Name as specified in the registry table of DICOM Unique Identifiers (UID) in PS 3.6, with phrase “and specializations” as appropriate | UID as specified in PS 3.6 | Yes/No | Yes/No |

Note: Any SOP specific behavior is documented later in the conformance statement in the applicable SOP specific conformance section.

**A.4.2.1.2 Association Policies**

Each AE Specification shall contain a description of the General Association Establishment and Acceptance policies of the AE.

**A.4.2.1.2.1 General**

The DICOM standard Application context shall be specified.

**Table A.4.2-2  
DICOM APPLICATION CONTEXT**

|                          |                       |
|--------------------------|-----------------------|
| Application Context Name | 1.2.840.10008.3.1.1.1 |
|--------------------------|-----------------------|

**A.4.2.1.2.2 Number of Associations.**

The number of simultaneous associations, which an Application Entity may support as a SCU or SCP, shall be specified. Any rules governing simultaneity of associations shall be defined here.

Note: For example an AE may have the capability to have up to 10 simultaneous associations, but may limit itself to have no more than 2 with any particular other AE. There may also be policies based upon combinations of simultaneous Real-World Activities.

**Table A.4.2-3**

**NUMBER OF ASSOCIATIONS AS AN ASSOCIATION INITIATOR FOR “APPLICATION ENTITY <1>”**

|                                             |   |
|---------------------------------------------|---|
| Maximum number of simultaneous associations | x |
|---------------------------------------------|---|

**Table A.4.2-4**

**NUMBER OF ASSOCIATIONS AS AN ASSOCIATION ACCEPTOR FOR “APPLICATION ENTITY <1>”**

|                                             |   |
|---------------------------------------------|---|
| Maximum number of simultaneous associations | x |
|---------------------------------------------|---|

**A.4.2.1.2.3 Asynchronous Nature**

If the implementation supports negotiation of multiple outstanding transactions, this shall be stated here, along with the maximum number of outstanding transactions supported.

**Table A.4.2-5**

**ASYNCHRONOUS NATURE AS AN ASSOCIATION INITIATOR FOR “APPLICATION ENTITY <1>”**

|                                                         |   |
|---------------------------------------------------------|---|
| Maximum number of outstanding asynchronous transactions | x |
|---------------------------------------------------------|---|

**A.4.2.1.2.4 Implementation Identifying Information**

The value supplied for Implementation Class UID shall be documented here. If a version name is supplied, this fact shall be documented here. Policies defining the values supplied for version name may be stated here.

**Table A.4.2-6**

**DICOM IMPLEMENTATION CLASS AND VERSION FOR “APPLICATION ENTITY <1>”**

|                             |                      |
|-----------------------------|----------------------|
| Implementation Class UID    | a.b.c.xxxxxxx.yyy.zz |
| Implementation Version Name | XYZxyz               |

**A.4.2.1.3 Association Initiation Policy**

This describes the conditions under which the AE will initiate an association.

**A.4.2.1.3.1 “Activity <1>”**

**A.4.2.1.3.1.1 Description and Sequencing of Activities**

If applicable, this section shall contain a description of sequencing of the events for “Activity <1>” (substitute actual activity name), including any applicable user interactions, which this specific AE performs. A UML sequence diagram, which depicts the Application Entity and Real-World Activities as vertical bars and shows the events exchanged between them as arrows, is strongly recommended.

Note: An example of a situation in which such a description is required is an AE, which supports both the Storage Service Class and the Modality Performed Procedure SOP Class. Some implementations might store the images before sending the final MPPS N-SET message while other implementations might send the final MPPS N-SET message before sending the images.

**A.4.2.1.3.1.2 Proposed Presentation Contexts**

Each time an association is initiated, the Association Initiator proposes a number of Presentation Contexts to be used on that association. In this subsection, the Presentation Contexts proposed by “Application Entity <1>” for “Activity <1>” shall be defined in a table with the following format:

**Table A.4.2-7  
PROPOSED PRESENTATION CONTEXTS FOR “APPLICATION ENTITY <1>”**

| Presentation Context Table |          |                           |                         |                  |                                         |
|----------------------------|----------|---------------------------|-------------------------|------------------|-----------------------------------------|
| Abstract Syntax            |          | Transfer Syntax           |                         | Role             | Extended Negotiation                    |
| Name                       | UID      | Name List                 | UID List                |                  |                                         |
| name_a                     | AS_UID_a | XS_Name_1, ..., XS_Name_n | XS_UID_1, ..., XS_UID_n | SCP   SCU   BOTH | None   See Note <1>   See table A.4.2-8 |
| ...                        | ...      | ...                       | ...                     | ...              | ...                                     |

Note<1>: <Describe the content of any extended negotiation done for the SOP Classes of this Presentation Context. One note may serve multiple Presentation Contexts, as a single Abstract Syntax often corresponds to a single SOP class, which may appear in different Presentation Contexts.>

In table A. 4.2.-7, the following meanings are assigned to the fields:

- <name\_a> This is the name of the Abstract Syntax to be used with this Presentation Context.
- <AS\_UID\_a> This is the UID of the Abstract Syntax to be used for this Presentation Context.
- <XS\_Name\_n> This is the name of a transfer syntax which may be used for this Presentation Context.
- <XS\_UID\_n> The UID of the corresponding transfer syntax

If the AE through this Real World Activity might propose any of the SOP Classes of a particular Service Class (e.g., the Storage Service Class), the Abstract Syntax Name and UID shall be those of the Service Class. This section shall describe the conditions under which a SOP Class of that Service Class will be proposed in a Presentation Context.

Note: For instance, an AE may receive instances of a non-preconfigured SOP Class through support of SOP Class Common Extended Negotiation. These instances may be limited to specializations of a



particular SOP Class, or they may be any SOP Class within the Service Class, and any such limits should be described.

This section shall describe the conditions under which the AE may change the SOP Class UID of SOP Instances sent, due to fall-back mechanisms.

Note: For instance, if the SCP does not accept the proposed Abstract Syntax (SOP Class) for which there is a Related General SOP Class that was accepted, the AE may modify SOP Instances of the refused SOP Class to use the Related General SOP Class for transmission.

In the event that the Abstract Syntax of the Presentation Context represents a Meta-SOP Class (that is, it includes many SOP Classes) and extended negotiation is supported for some of these SOP Classes, the following table is required to define this extended negotiation. This table is referenced in table A. 4.2-7:

**Table A.4.2-8  
EXTENDED NEGOTIATION AS A SCU**

| SOP Class Name | SOP Class UID | Extended Negotiation |
|----------------|---------------|----------------------|
| Name_i         | SOP_UID_I     | None   See Note <1>  |
| ...            | ...           | ...                  |

Note<1>: <Describe the content of any extended negotiation done for this SOP Class. One note may serve multiple Presentation Contexts, as a SOP class which may appear in different Presentation Contexts and/or Meta SOP Classes.>

The implementation of the initiator shall document which Transfer Syntax will be chosen in case multiple Transfer Syntaxes are accepted during the Association Acceptance.

#### **A.4.2.1.3.1.3 SOP Specific Conformance for SOP Class(es)**

This section includes the SOP specific behavior, i.e. error codes, error and exception handling, time-outs, etc. The information shall be as described in the SOP specific Conformance Statement section of PS 3.4 (or relevant private SOP definition). It shall include the content of any extended negotiation. Keys shall be specified including how they are used (Matching, return keys, interactive query, whether they are displayed to the user, universal and/or list matching, etc.).

In particular, the behavior associated with the exchange of images available to the AE only in a lossy compressed form shall be documented. For example, if a lossy compressed transfer syntax is not negotiated, will the AE decompress the image data and send it using one of the negotiated transfer syntaxes.

All details regarding the specific conformance, including response behavior to all status codes, both from an application level and communication errors shall be provided in the form of a table as follows:

**Table A.4.2-9  
DICOM COMMAND RESPONSE STATUS HANDLING BEHAVIOR**

| Service Status | Further Meaning           | Error Code | Behavior                                                         |
|----------------|---------------------------|------------|------------------------------------------------------------------|
| e.g. Success   | e.g. Matching is complete | e.g.0000   | e.g. The SCP has successfully returned all matching information. |
| Warning        |                           |            |                                                                  |
| Error          |                           |            |                                                                  |
| .....          |                           |            |                                                                  |

The behavior of the AE during communication failure is summarized in a table as follows:

- Standard -

**Table A.4.2-10  
DICOM COMMAND COMMUNICATION FAILURE BEHAVIOR**

| <b>Exception</b>         | <b>Behavior</b>                                                                                                            |
|--------------------------|----------------------------------------------------------------------------------------------------------------------------|
| e.g. Timeout             | e.g. The Association is aborted using A-ABORT and command marked as failed. The reason is logged and reported to the user. |
| e.g. Association aborted | e.g. The command is marked as failed. The reason is logged and reported to the user.                                       |

**A.4.2.1.4 Association Acceptance Policy**

Each AE Specification shall contain a description of the Association Acceptance policies of the AE. This describes the conditions under which the AE will accept an association.

**A.4.2.1.4.1 “Activity <2>”**

**A.4.2.1.4.1.1 Description and sequencing of Activities**

**A.4.2.1.4.1.2 Accepted Presentation Contexts**

**Table A.4.2-11  
ACCEPTABLE PRESENTATION CONTEXTS FOR  
”APPLICATION ENTITY <1>” AND “ACTIVITY <2>”**

| <b>Presentation Context Table</b> |            |                        |            |                        |                                                  |
|-----------------------------------|------------|------------------------|------------|------------------------|--------------------------------------------------|
| <b>Abstract Syntax</b>            |            | <b>Transfer Syntax</b> |            | <b>Role</b>            | <b>Extended Negotiation</b>                      |
| <b>Name</b>                       | <b>UID</b> | <b>Name</b>            | <b>UID</b> |                        |                                                  |
| name_a                            | AS_UID_a   | XS_Name_a              | XS_UID_a   | SCP  <br>SCU  <br>Both | None  <br>See Note<br><1>  See<br>table A.4.2-12 |
| ...                               | ...        | ...                    | ...        | ...                    | ...                                              |

Note<1>: <Describe the content of any extended negotiation done for the SOP Classes of this Presentation Context. In particular, acceptance of specialized SOP Classes of the Abstract Syntax specified in this Presentation Context shall be noted. One note may serve multiple Presentation Contexts, as a single Abstract Syntax often corresponds to a single SOP class, which may appear in different Presentation Contexts.>

In table A.4.2-11, the following meanings are assigned to the fields:

<name\_a> This is the name of the Abstract Syntax to be used with this Presentation Context.

<AS\_UID\_a> This is the UID of the Abstract Syntax to be used for this Presentation Context.

<XS\_Name\_a> This is the name of a Transfer Syntax which may be used for this Presentation Context.

<XS\_UID\_a> The UID of the corresponding transfer syntax.

If the AE through this Real World Activity supports all SOP Classes of a particular Service Class (e.g., the Storage Service Class) through SOP Class Common Extended Negotiation, the Abstract Syntax Name and UID shall be those of the Service Class, and this shall be noted under Extended Negotiation.

In the event that the Abstract Syntax of the Presentation Context represents a Meta-SOP Class (that is, it includes many SOP Classes) and extended negotiation is supported for some of these SOP Classes, the following table is required to define this extended negotiation. This table is referenced in table A.4.2-11

**Table A.4.2 – 12  
EXTENDED NEGOTIATION AS A SCP**

| SOP Class name | SOP Class UID | Extended Negotiation |
|----------------|---------------|----------------------|
| Name_i         | SOP_UID_I     | None   See Note <1>  |
| ...            | ...           | ...                  |

Note<1>: <Describe the content of any extended negotiation done for this SOP Class. One note may serve multiple Presentation Contexts, as a SOP class, which may appear in different Presentation Contexts, and/or Meta SOP Classes.>

Any rules that govern the acceptance of presentation contexts for this AE shall be stated here as well. This includes rules for which combinations of Abstract/Transfer Syntaxes are acceptable, and rules for prioritization of presentation contexts. Rules that govern selection of transfer syntax within a presentation context shall be stated here.

**A.4.2.1.4.1.3 SOP Specific Conformance for SOP Class(es)**

This section includes the SOP specific behavior, i.e. error codes, error and exception handling, time-outs, etc. The information shall be as described in the SOP specific Conformance Statement section of PS 3.4 (or relevant private SOP definition).

The behavior of an Application Entity shall be summarized as shown in Table 4.2.13. Standard as well as the manufacturer specific status codes and their corresponding behavior shall be specified.

**Table 4.2 - 13  
STORAGE C-STORE RESPONSE STATUS**

| Service Status | Further Meaning                   | Error Code | Reason  |
|----------------|-----------------------------------|------------|---------|
| Success        | Success                           | 0000       | Explain |
| Refused        | Out of Resources                  | A700-A7FF  | Explain |
| Error          | Data Set does not match SOP Class | A900-A9FF  | Explain |
| Error          | Specify                           | Specify    | Explain |
| Warning        | Specify                           | Specify    | Explain |

**A.4.2.2 “Application Entity <2>”**

The same info shall be repeated for each additional AE.

**A.4.3 NETWORK INTERFACES**

**A.4.3.1 Physical Network Interface**

If applicable, specifies what physical network interface(s) are supported.

### A.4.3.2 Additional Protocols

Additional protocols such as used for configuration management are listed here. Any conformance to specific System Management Profiles defined in PS3.15 shall be listed per the following table.

Table A.4.3-1  
System Management Profiles Table

| Profile Name | Actor    | Protocols Used            | Optional Transactions         | Security Support |
|--------------|----------|---------------------------|-------------------------------|------------------|
| Profile (1)  | P Client | Protocol_1,<br>Protocol_2 | N/A                           |                  |
| Profile (x)  | X Client | Protocol_2,<br>Protocol_3 | Protocol_3 Option_A supported |                  |

If the implementation conforms to the Basic Network Address Management Profile as a DHCP Client actor (see PS3.15), the use of DHCP to configure the local IP address and hostname shall be described.

Note: The hostname is an alias for the IP address, and has no semantic relationship to AE titles. It is solely a convenience for configuration description.

If the implementation conforms to the Basic Network Address Management Profile as a DNS Client actor (see PS3.15), the use of DNS to obtain IP addresses from hostname information shall be described.

If the implementation conforms to the Basic Time Synchronization profile as an NTP Client or SNTP Client, the available NTP configuration alternatives shall be described. If the implementation conforms to the Basic Time Synchronization Profile as an NTP Server, the available server configuration alternatives shall be described. Any device specific requirements for accuracy or maximum allowable synchronization error shall be described.

### A.4.3.3 IPv4 and IPv6 Support

The support for specific IPv4 and IPv6 features and associated optional IPv6 security and configuration facilities shall be documented.

## A.4.4 CONFIGURATION

Any implementation's DICOM conformance may be dependent upon configuration, which takes place at the time of installation. Issues concerning configuration shall be addressed in this section.

### A.4.4.1 AE Title/Presentation Address Mapping

An important installation issue is the translation from AE title to Presentation Address. How this is to be performed shall be described in this section.

Note: There does not necessarily have to be a one to one relationship between AE titles and Application Entities. If so, this should be made clear in the tables.

#### A 4.4.1.1 Local AE Titles.

The local AE title mapping and configuration shall be specified. The following table shall be used:

Table A.4.4-1  
AE TITLE CONFIGURATION TABLE

| Application Entity | Default AE Title | Default TCP/IP Port |
|--------------------|------------------|---------------------|
| AE (1)             | Name             | Specify             |
| AE (2)             | Name             | Specify             |
| AE (x)             |                  |                     |

If the implementation conforms to the Application Configuration Management Profile as an LDAP Client actor (see PS3.15), any use of LDAP to configure the local AE titles shall be described. Any conformance to the Update LDAP Server option shall be specified, together with the values for all component object attributes in the update sent to the LDAP Server.

**A 4.4.1.2 Remote AE Title/Presentation Address Mapping**

Configuration of remote host names and port numbers shall be specified here.

**A 4.4.1.2.1 Remote SCP 1**

Configuration of the remote AET port number, host-names, IP addresses and capabilities shall be specified. If applicable, multiple remote SCP's can be specified.

If the implementation conforms to the Application Configuration Management Profile as an LDAP Client actor (see PS3.15), any use of LDAP to configure the remote device addresses and capabilities shall be described. The LDAP queries used to obtain remote device component object attributes shall be specified.

Note: In particular, use of LDAP to obtain the AE Title, TCP port, and IP address for specific system actors (e.g., an Image Archive, or a Performed Procedure Step Manager) should be detailed, as well as how the LDAP information for remote devices is selected for operational use.

**A 4.4.1.2.2 Remote SCP 2**

Etc.

**A.4.4.2 Parameters**

The specification of important operational parameters, and if configurable, their default value and range, shall be specified here. The parameters that apply to all Application Entities should be specified in a "General Parameters" section while those specific to particular Application Entities should be specified in separate sections specific to each AE. The following table which is shown here with a recommended baseline of parameters, shall be used:

**Table A.4.4-2  
CONFIGURATION PARAMETERS TABLE**

| Parameter                                                                                                         | Configurable<br>(Yes/No) | Default Value |
|-------------------------------------------------------------------------------------------------------------------|--------------------------|---------------|
| <b>General Parameters</b>                                                                                         |                          |               |
| Time-out waiting for acceptance or rejection Response to an Association Open Request. (Application Level timeout) |                          |               |
| General DIMSE level time-out values                                                                               |                          |               |
| Time-out waiting for response to TCP/IP connect request. (Low-level timeout)                                      |                          |               |
| Time-out waiting for acceptance of a TCP/IP message over the network. (Low-level timeout)                         |                          |               |
| Time-out for waiting for data between TCP/IP packets. (Low-level timeout)                                         |                          |               |
| Any changes to default TCP/IP settings, such as configurable stack parameters.                                    |                          |               |
| Other configurable parameters                                                                                     |                          |               |
| <b>AE Specific Parameters</b>                                                                                     |                          |               |
| Size constraint in maximum object size (see note 1)                                                               |                          |               |

| Parameter                                                                                 | Configurable<br>(Yes/No) | Default Value |
|-------------------------------------------------------------------------------------------|--------------------------|---------------|
| <b>General Parameters</b>                                                                 |                          |               |
| Maximum PDU size the AE can receive                                                       |                          |               |
| Maximum PDU size the AE can send                                                          |                          |               |
| AE specific DIMSE level time-out values                                                   |                          |               |
| Number of simultaneous Associations by Service and/or SOP Class                           |                          |               |
| <SOP Class support> (e.g. Multi-frame vs. single frame vs. SC support), when configurable |                          |               |
| <Transfer Syntax support>, e.g. JPEG, Explicit VR, when configurable                      |                          |               |
| Other parameters that are configurable                                                    |                          |               |

Note 1: In particular when accommodating Multiframe objects (e.g. Ultrasound Multiframe, NM, XA, RF), a receiver might have a certain restriction with regard to its maximum length. This restriction should be specified here.

Additional configuration parameters such as hardware options for e.g. a printer shall be specified as well.

## **A.5 MEDIA INTERCHANGE**

### **A.5.1 IMPLEMENTATION MODEL**

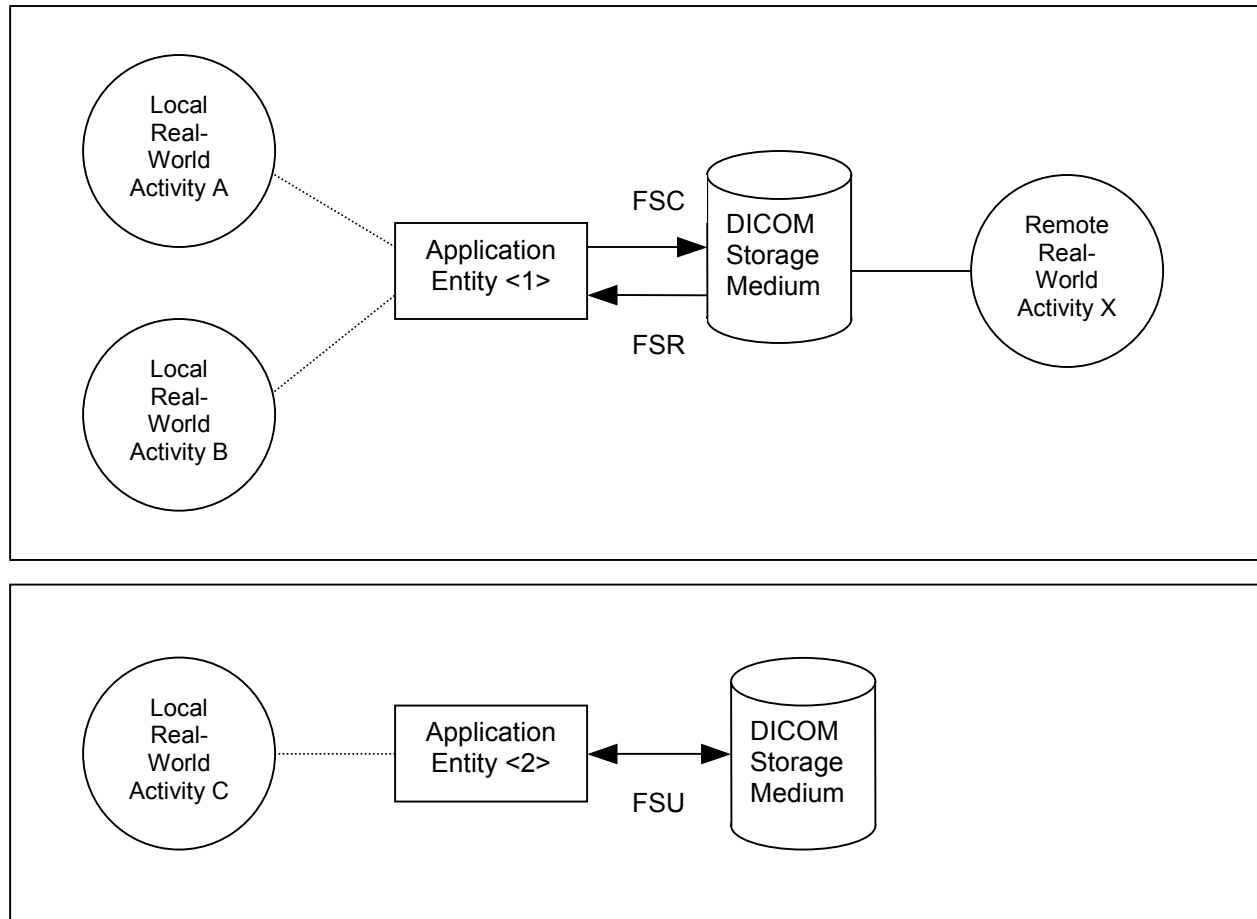
The Implementation Model shall identify the DICOM Application Entities in a specific implementation and relate the Application Entities to Real-World Activities.

#### **A.5.1.1 Application Data Flow Diagram**

As part of the Implementation Model, an Application Data Flow Diagram shall be included. This diagram represents all of the Application Entities present in an implementation and graphically depicts the relationship of the AE's use of DICOM to real world activities. Figure A.5.1-1 is a template for such a Data Flow Diagram. Accompanying the Application Data Flow Diagram shall be a discussion of the Application Data Flow represented.

In this illustration, according to figure A.5.1 -1, an occurrence of local Real-World Activity A or B will cause the local Application Entity 1 to initiate either creation of a File-set on a medium (FSC) for the purpose of interchange with a remote Real-World Activity X or to access a File-set on a medium for reading (FSR). The remote Real-World Activity X accesses the medium physically transferred from Real-World Activity A or B.

An occurrence of Real-World Activity C will cause the local Application Entity 2 to update a File-set (FSU) on a mounted medium.



**Figure A.5.1-1.**  
**APPLICATION DATA FLOW DIAGRAM**

Note: If the AE expects a remote Real-World Activity to access the media for a specific purpose, this should be shown in the Application Data Flow Diagram as well as described in Section A.5.1.1.

### A.5.1.2 Functional definitions of AE's

The next part of the Conformance Statement shall contain a functional definition for each local Application Entity. This shall describe in general terms the functions to be performed by the AE, and the DICOM services used to accomplish these functions. In this sense "DICOM services" refers not only to DICOM Service Classes, but also to lower level DICOM services, such as the Media File System and mapping to particular Media Formats.

### A.5.1.3 Sequencing of Real World Activities

If applicable, this section shall contain a description of sequencing of Real World Activities that the AE's require.

Note: An example of a situation in which a such a description is required is an AE which supports roles as a File-set Updater and File-set Reader. In some instances, the File-set will be updated then read (e.g., for verification); and in other instances, may be read first to determine if the File-set needs to be updated.

### A.5.1.4 File Meta Information for Implementation Class and Version

This section shall be used to list the values assigned to the File Meta Information attributes (see PS 3.10) that pertain to the Implementation Class and Version. These are:



- File Meta Information Version
- Implementation Class UID
- Implementation Version Name

## A.5.2 AE SPECIFICATIONS

The next section in the DICOM Conformance Statement is a set of Application Entity Specifications. There shall be one such specification for each Application Entity type.

### A.5.2.1 “Application Entity <1>” - Specification

The following table, Table A.5.2-1, shows that for one or more Application Profiles in the first column, there are a number of Real-World Activities in the second column and the roles required for each of these Real-World Activities in the third column

**Table A.5.2-1  
AE RELATED APPLICATION PROFILES, REAL-WORLD ACTIVITIES, AND ROLES**

| Supported Application Profile | Real-World Activity | Roles    |  |
|-------------------------------|---------------------|----------|--|
| STD-AP1                       | RWA A               | FSR      |  |
|                               | RWA B               | FSR, FSC |  |
| STD-AP1, AUG-AP2, etc.        | RWA C               | FSU      |  |
|                               | RWA D               | FSC      |  |

This section shall also contain any general policies that apply to all of the AEs described in subsequent section.

#### A.5.2.1.1 File Meta Information for the “Application Entity <1>”

This section shall contain the values of the File Meta Information that pertain to the Application Entity (see PS 3.10). These are:

- Source Application Entity Title

If Private Information is used in the Application Profile File Meta Information, the following two File Meta Information attributes may be documented:

- Private Information Creator UID
- Private Information

#### A.5.2.1.2 Real-World Activities

The first sentence in this section shall state the Roles and Media Storage Service Class Options supported by the “Application Entity <1>”.

##### A.5.2.1.2.i “Real-World Activity <I>”

The AE Specification shall contain a description of the Real-World Activities, which invoke the particular AE. There will be one section, A.5.2.1.2.i where i increments for each RWA, per Real-World Activity.

##### A.5.2.1.2.i.1 Media Storage Application Profile

The Application Profile that is used by the AE described in A.5.2-1 is specified in this section.

#### **A.5.2.1.2.i.1.y Options**

The options used in the Application Profile specified in table A.5.2-1 shall be detailed in this section. There will be separate sections for each option specified for the AP. If there are no options used in the Application Profile specified in A.5.2.x, this section may be omitted.

#### **A.5.2.2 “Application Entity <2>” - Specification**

Each individual AE Specification has a subsection, A.5.2.x. There are as many of these subsections as there are different AE's in the implementation. That is, if there are two distinct AE's, then there will be two subsections, A.5.2.1, and A.5.2.2.

### **A.5.3 AUGMENTED AND PRIVATE APPLICATION PROFILES**

This Section shall be used for the description of Augmented and Private Application Profiles.

#### **A.5.3.1 Augmented Application Profiles**

Any Augmented Application Profiles used by an AE shall be described in these sections. The rules governing the structure of an Augmented AP shall be described.

##### **A.5.3.1.1 “Augmented Application Profile <1>”**

Each Augmented Application Profile shall have a section A.5.3.1.x that describes the specific features of the Application Profile that make it Augmented. These shall be described in the three repeating sections that follow.

##### **A.5.3.1.1.1 SOP Class Augmentations**

The additional SOP Classes beyond those specified in the Standard AP on which this Augmented AP is based shall be detailed in this section.

##### **A.5.3.1.1.2 Directory Augmentations**

Any additions to the Directory IOD that augment this AP shall be described in this section.

##### **A.5.3.1.1.3 Other Augmentations**

Any additions to, or extensions of the Application Profile shall be described in this section. An example of such another augmentation is addition of a role (FSR, FSC, FSU) to the Standard Application Profile set of defined roles.

##### **A.5.3.1.2 “Augmented Application Profile <2>”**

To be repeated for the second, third, etc. Augmented Application Profile.

#### **A.5.3.2 Private Application Profiles**

The rules that govern construction of a Private Application Profile shall be described. This section shall be used to describe the details of the Private AP.

- Notes:
1. Refer to PS 3.11 for a description of constructing a Private Application Profile.
  2. If the AP deviates from the rules governing a Private AP in any manner, it is non-conformant and is outside the scope of this Standard.

### **A.5.4 MEDIA CONFIGURATION**

Any implementation's DICOM conformance may be dependent upon configuration that takes place at the time of installation. Issues concerning configuration shall be addressed in this section (e.g. the configuration of the Source AE Title in File Meta Information).

## A.6 SUPPORT OF CHARACTER SETS

Any support for Character Sets beyond the Default Character Repertoire in Network and Media Services shall be described here.

- The behavior when an unsupported character set is received shall be documented.
- Character set configuration capabilities, if any, shall be specified.
- Mapping and/or conversion of character sets across Services and Instances shall be specified.
- Query capabilities for attributes that include non-default character sets, both for the Worklist service class and Query service class shall be specified. Behavior of attributes using extended character sets by a C-FIND, both as SCU and SCP request and response, shall be specified. In particular the handling of Person Names (VR of PN) shall be specified.
- The presentation of the characters to a user, i.e. capabilities, font limitations and/or substitutions shall be specified.

## **A.7 SECURITY**

### **A.7.1 SECURITY PROFILES**

Any support for Security profiles as defined in PS 3.15 shall be described here:

An implementation shall declare which level of security features it supports, including such things as:

- a. The conditions under which the implementation preserves the integrity of Digital Signatures (e.g. is the implementation bit-preserving).
- b. The conditions under which the implementation verifies incoming Digital Signatures.
- c. The conditions under which the implementation replaces Digital Signatures.
- d. IPv6 Security capabilities

### **A.7.2 ASSOCIATION LEVEL SECURITY**

Any support for security at the Association level (e.g. allowing only certain AE-titles and/or IP addresses to open an Association) shall be specified here.

### **A.7.3 APPLICATION LEVEL SECURITY**

Any support for additional application level security as it applies to the DICOM communication (e.g. passwords, biometrics) can be described here.

## A.8 ANNEXES

### A.8.1 IOD CONTENTS

#### A.8.1.1 Created SOP Instance(s)

This section specifies each IOD created (including Private IOD's). It should specify the Attribute Name, tag, VR, and Value. The Value should specify the range and source (e.g. User input, Modality Worklist, automatically generated, etc.). For content items in templates, the range and source of the concept name and concept values should be specified. Whether the value is always present or not shall be specified.

Recommended abbreviations to be used for the tables are:

|        |                                                                              |
|--------|------------------------------------------------------------------------------|
| VNAP   | Value Not Always Present (attribute sent zero length if no value is present) |
| ANAP   | Attribute Not Always Present                                                 |
| ALWAYS | Always Present with a value                                                  |
| EMPTY  | Attribute is sent without a value                                            |

Recommended abbreviations to be used for the source of the data values in the tables are:

|                |                                                                                                                                                |
|----------------|------------------------------------------------------------------------------------------------------------------------------------------------|
| USER           | the attribute value source is from User input                                                                                                  |
| AUTO           | the attribute value is generated automatically                                                                                                 |
| MWL,MPPS, etc. | the attribute value is the same as the value received using a DICOM service such as Modality Worklist, Modality Performed Procedure Step, etc. |
| CONFIG         | the attribute value source is a configurable parameter                                                                                         |

Specification of a company web address can refer to sample SOP Instances that are available.

Private attributes should be specified.

#### A.8.1.2 Usage of Attributes from received IOD's

Each Application that depends on certain fields to function correctly should specify which ones are required for it to perform its intended function.

#### A.8.1.3 Attribute Mapping

When attributes are used by different SOP Classes, e.g. Modality Worklist, Storage and Modality Performed Procedure Step, this mapping shall be specified. For devices that specify other external protocols, such as HL7, mapping of their fields into the DICOM attributes is not required but highly recommended.

#### A.8.1.4 Coerced/Modified fields

A SCU might coerce certain Attributes, e.g. the Patient Name. A SCP might provide a different value of an Attribute than was received. These changes shall be specified here. An example is Patient Name, which could be modified using available information from either an internal database or obtained from an Information System/Information Manager. Another example is the generation of a new SOP Instance UID for an existing instance. The conditions influencing such coercion should be specified..

## A.8.2 DATA DICTIONARY OF PRIVATE ATTRIBUTES

Any private Attributes should be specified, including VR and VM, should be specified. Private SOP Classes and Transfer syntaxes should be listed.

## A.8.3 CODED TERMINOLOGY AND TEMPLATES

Support for Coded Terminology and templates shall be described here.

### A.8.3.1 Context Groups

Each Context Group (i.e., use of coded terminology in a specific context) shall be specified here with its default value set, and whether the value set is configurable. The configurable options are specified.

**Table A.8.3-1  
CONTEXT GROUPS**

| Context Group                                 | Default Value Set                                          | Configurable                     | Use                                                                                                                                                                                                                                                                                                            |
|-----------------------------------------------|------------------------------------------------------------|----------------------------------|----------------------------------------------------------------------------------------------------------------------------------------------------------------------------------------------------------------------------------------------------------------------------------------------------------------|
| Logical Context Identification                | CID xxx   extended<br>CID xxx   Private CID<br>yyyy   None | No <br>Extensible Re<br>placable | Description of method of selection of a term from the Context Group, and identification of the IOD, Attribute, and/or Content Item that uses the term                                                                                                                                                          |
| e.g., Acquisition Protocol Equipment Settings | e.g., None                                                 | e.g.,<br>Replaceable             | e.g., Value of Scheduled Protocol Code Sequence (0040,0008) from selected Modality Worklist Scheduled Procedure Step is matched to this group for protocol-assisted equipment set-up. Selected value from this group is used in Modality Performed Procedure Step Performed Protocol Code Sequence (0040,0260) |
| e.g., Patient Orientation                     | e.g., CID 19                                               | e.g., No                         | e.g., Mapped from user console selection of Patient Orientation. Used in Patient Orientation Code Sequence (0054,0410)                                                                                                                                                                                         |
| ...                                           | ...                                                        | ...                              | ...                                                                                                                                                                                                                                                                                                            |

The Default Value Set may be an extension of a standard context group (“extended CID xxx”). If used, a table shall be provided specifying the extended context group, the Context Group Local Version (0008,0107) value and the Context Group Creator UID (0008,010D).

This section describes the specification of any private context groups that are used. It shall follow the format for context groups specified in PS 3.16.

### A.8.3.2 Template Specifications

This section specifies any extensions to standard templates and/or any private templates that are used, and defines them. Definitions shall follow the format for templates specified in PS 3.16

### A.8.3.3 Private Code definitions

This section specifies any private codes used and their definitions.

#### **A.8.4 GRAYSCALE IMAGE CONSISTENCY**

Any support for the DICOM Grayscale Standard Display Function will be specified in this section.

#### **A.8.5 STANDARD EXTENDED/SPECIALIZED/PRIVATE SOP CLASSES**

This section describes Standard Extended SOP Class, Specialized SOP Class, or Private SOP Class that are used.

##### **A.8.5.1 Standard Extended/Specialized/Private SOP i**

This section describes a particular Standard Extended SOP Class, Specialized SOP Class, or Private SOP Class.

#### **A.8.6 PRIVATE TRANSFER SYNTAXES**

This section describes any private Transfer Syntaxes that are listed in the Transfer Syntax Tables.

##### **A.8.6.1 Private Transfer Syntax i**

This section describes particular private transfer syntax. It shall follow the guidelines specified in PS 3.5.

**ANNEX B (Informative) CONFORMANCE STATEMENT  
SAMPLE INTEGRATED MODALITY**

Disclaimer:

This document is an example DICOM Conformance Statement for a fictional image acquisition modality called EXAMPLE-INTEGRATED-MODALITY produced by a fictional vendor called EXAMPLE-IMAGING-PRODUCTS.

As stated in the annex title, this document is truly informative, and not normative. A conformance statement of an actual product might implement additional services and options as appropriate for its specific purpose. In addition, an actual product might implement the services described in a different manner and, for example, with different characteristics and/or sequencing of activities. In other words, this conformance statement example does not intend to standardize a particular manner that a product might implement DICOM functionality.



**B.0 COVER PAGE**

Company Name: EXAMPLE-IMAGING-PRODUCTS.

Product Name: SAMPLE INTEGRATED MODALITY

Version: 1.0-rev. A.1

Internal document number: 4226-xxx-yyy-zzz rev 1

Date: YYYYMMDD

## B.1 CONFORMANCE STATEMENT OVERVIEW

This fictional product EXAMPLE-INTEGRATED-MODALITY implements the necessary DICOM services to download work lists from an information system, save acquired RF images and associated Presentation States to a network storage device or CD-R, print to a networked hardcopy device and inform the information system about the work actually done.

Table B.1-1 provides an overview of the network services supported by EXAMPLE-INTEGRATED-MODALITY.

**Table B.1-1  
NETWORK SERVICES**

| <b>SOP Classes</b>                    | <b>User of Service (SCU)</b> | <b>Provider of Service (SCP)</b> |
|---------------------------------------|------------------------------|----------------------------------|
| <b>Transfer</b>                       |                              |                                  |
| X-Ray RadioFluoroscopic Image Storage | Yes                          | No                               |
| Grayscale Softcopy Presentation State | Yes                          | No                               |
| <b>Workflow Management</b>            |                              |                                  |
| Modality Worklist                     | Yes                          | No                               |
| Storage Commitment Push Model         | Yes                          | No                               |
| Modality Performed Procedure Step     | Yes                          | No                               |
| <b>Print Management</b>               |                              |                                  |
| Basic Grayscale Print Management      | Option (see Note 1)          | No                               |
| Presentation LUT                      | Option (see Note 1)          | No                               |

NOTE 1: Support for the Print Services is a separately licensable option. Details about licensable options can be found under:  
<http://www.example-imaging-products.nocom/exampleintegrated-modality/licence-options>

Table B.1-2 provides an overview of the Media Storage Application Profiles supported by Example-Integrated-Modality.

**Table B.1-2  
MEDIA SERVICES**

| <b>Media Storage Application Profile</b> | <b>Write Files (FSC or FSU)</b> | <b>Read Files (FSR)</b> |
|------------------------------------------|---------------------------------|-------------------------|
| <b>Compact Disk – Recordable</b>         |                                 |                         |
| General Purpose CD-R                     | Yes                             | No                      |

## B.2 TABLE OF CONTENTS

A table of contents shall be provided to assist readers in easily finding the needed information.

## B.3 INTRODUCTION

### B.3.1 REVISION HISTORY

| Document Version | Date of Issue    | Author | Description            |
|------------------|------------------|--------|------------------------|
| 1.1              | October 30, 2003 | WG 6   | Version for Final Text |
| 1.2              | August 30, 2007  | WG 6   | Revised Introduction   |

### B.3.2 AUDIENCE, REMARKS, TERMS AND DEFINITIONS, BASICS OF DICOM COMMUNICATION, ABBREVIATIONS, REFERENCES

*See example text in Annex A.3.*

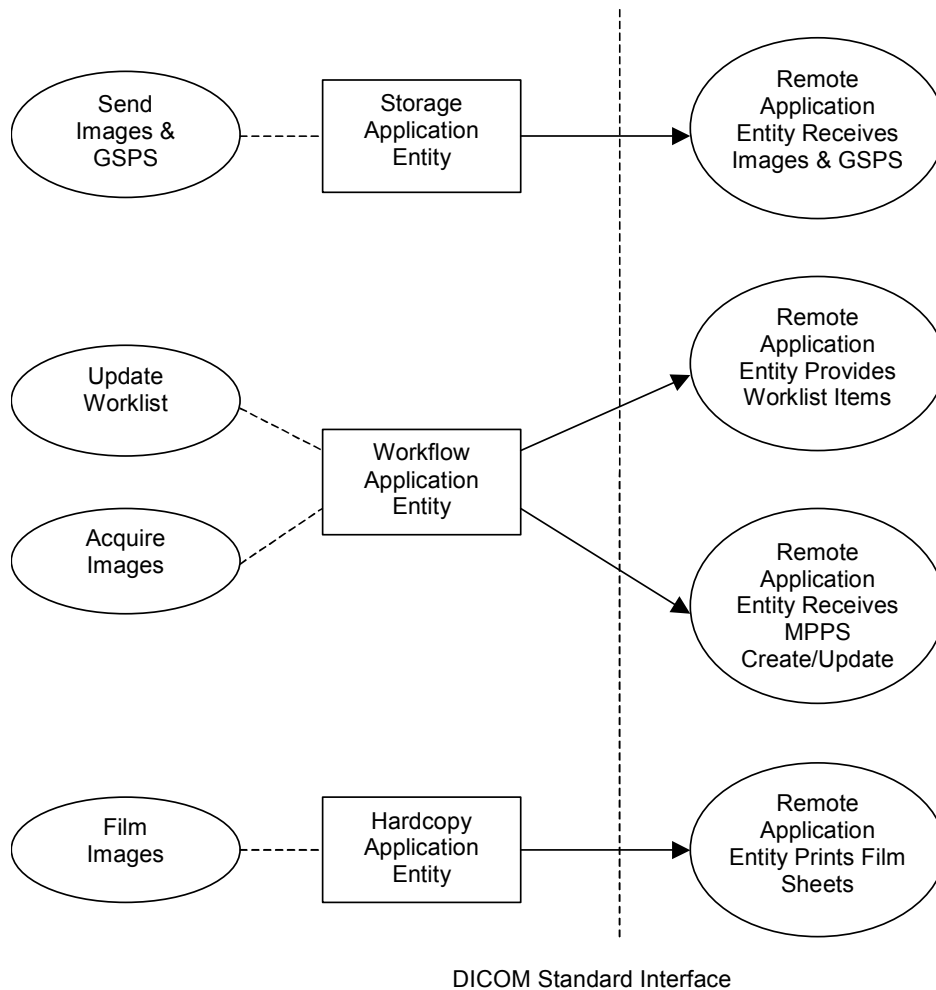
### B.3.3 ADDITIONAL REMARKS FOR THIS EXAMPLE

This document is a sample DICOM Conformance Statement created for DICOM PS3.2. It is to be used solely as an example to illustrate how to create a DICOM Conformance Statement for an acquisition modality. The subject of the document, EXAMPLE-INTEGRATED-MODALITY, is a fictional product.

## B.4 NETWORKING

### B.4.1 IMPLEMENTATION MODEL

#### B.4.1.1 Application Data Flow



**Figure B.4.1-1**  
**APPLICATION DATA FLOW DIAGRAM**

- The Storage Application Entity sends images and Presentation States to a remote AE. It is associated with the local real-world activity “Send Images & GSPS”. “Send Images & GSPS” is performed upon user request for each study completed or for specific images selected. When activated by user’s settings (auto-send), each marked set of images and associated Presentation States can be immediately stored to a preferred destination whenever a Patient/Study is closed by the user. If the remote AE is configured as an archive device the Storage AE will request Storage Commitment and if a commitment is successfully obtained will record this information in the local database.

- The Workflow Application Entity receives Worklist information from and sends MPPS information to a remote AE. It is associated with the local real-world activities “Update Worklist” and “Acquire Images”. When the “Update Worklist” local real-world activity is performed the Workflow Application Entity queries a remote AE for worklist items and provides the set of worklist items matching the query request. “Update Worklist” is performed as a result of an operator request or can be performed automatically at specific time intervals. When the “Acquire Images” local real-world activity is performed the Workflow Application Entity creates and updates Modality Performed Procedure Step instances managed by a remote AE. Acquisition of images will result in automated creation of an MPPS Instance. Completion of the MPPS is performed as the result of an operator action.
  
- The Hardcopy Application Entity prints images on a remote AE (Printer). It is associated with the local real-world activity “Film Images”. “Film Images” creates a print-job within the print queue containing one or more virtual film sheets composed from images selected by the user.

#### **B.4.1.2 Functional Definition of AEs**

##### **B.4.1.2.1 Functional Definition of Storage Application Entity**

The existence of a send-job queue entry with associated network destination will activate the Storage AE. An association request is sent to the destination AE and upon successful negotiation of a Presentation Context the image transfer is started. If the association cannot be opened, the related send-job is set to an error state and can be restarted by the user via job control interface. By default, the Storage AE will not try to initiate another association for this send-job automatically. However, an automatic retry (retry-timer, retrycount) can be configured by a CSE.

##### **B.4.1.2.2 Functional Definition of Workflow Application Entity**

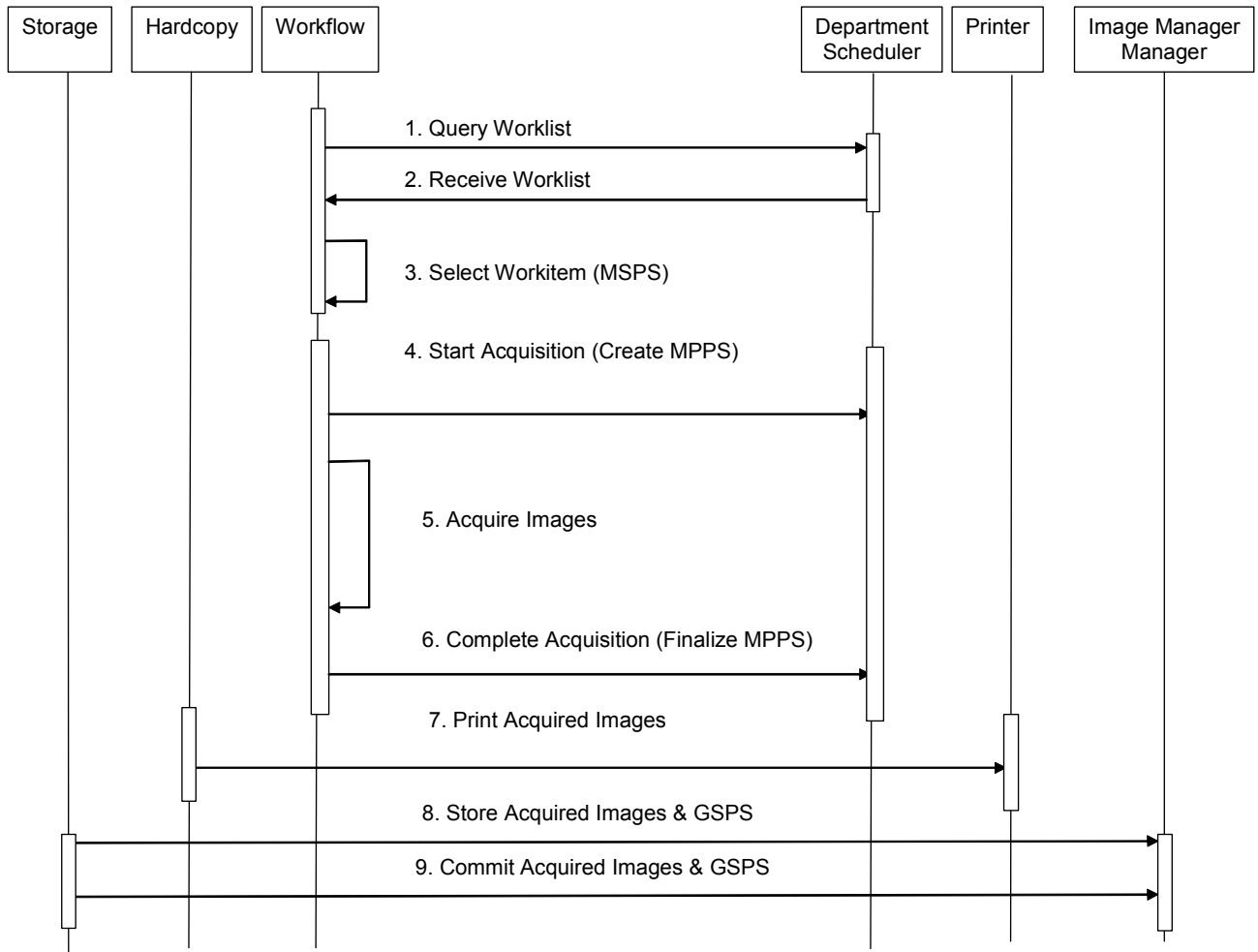
Worklist Update attempts to download a Worklist from a remote node. If the Workflow AE establishes an Association to a remote AE, it will transfer all worklist items via the open Association. During receiving the worklist response items are counted and the query processing is canceled if the configurable limit of items is reached. The results will be displayed in a separate list, which will be cleared with the next Worklist Update.

The Workflow AE performs the creation of a MPPS Instance automatically whenever images are acquired. Further updates on the MPPS data can be performed interactively from the related MPPS user interface. The MPPS “Complete” or “Discontinued” states can only be set from the user interface.

##### **B.4.1.2.3 Functional Definition of Hardcopy Application Entity**

The existence of a print-job in the print queue will activate the Hardcopy AE. An association is established with the printer and the printer’s status determined. If the printer is operating normally, the film sheets described within the print-job will be printed. Changes in printer status will be detected (e.g. out of film) and reported to the user. If the printer is not operating normally, the print-job will set to an error state and can be restarted by the user via the job control interface.

### B.4.1.3 Sequencing of Real-World Activities



**Figure B.4.1-2**  
**SEQUENCING CONSTRAINTS**

Under normal scheduled workflow conditions the sequencing constraints illustrated in Figure B.4.1-2 apply:

1. Query Worklist
2. Receive Worklist of Modality Scheduled Procedure Steps (MSPS)
3. Select Workitem (MSPS) from Worklist
4. Start acquisition and create MPPS
5. Acquire Images
6. Complete acquisition and finalize MPPS
7. Print acquired images (optional step)

8. Store acquired images and any associated Grayscale Softcopy Presentation State (GSPS) instances.
9. If the Image Manager is configured as an archive device the Storage AE will request Storage Commitment for the images and associated GSPS instances.

Other workflow situations (e.g. unscheduled procedure steps) will have other sequencing constraints. Printing could equally take place after the acquired images have been stored. Printing could be omitted completely if no printer is connected or hardcopies are not required.

## B.4.2 AE SPECIFICATIONS

### B.4.2.1 Storage Application Entity Specification

#### B.4.2.1.1 SOP Classes

EXAMPLE-INTEGRATED-MODALITY provides Standard Conformance to the following SOP Classes:

**Table B.4.2-1  
SOP CLASSES FOR AE STORAGE**

| SOP Class Name                                | SOP Class UID                | SCU | SCP |
|-----------------------------------------------|------------------------------|-----|-----|
| X-Ray RadioFluoroscopic Image Storage         | 1.2.840.10008.5.1.4.1.1.12.2 | Yes | No  |
| Grayscale Softcopy Presentation State Storage | 1.2.840.10008.5.1.4.1.1.11.1 | Yes | No  |
| Storage Commitment Push Model                 | 1.2.840.10008.1.20.1         | Yes | No  |
| Verification                                  | 1.2.840.10008.1.1            | No  | Yes |

#### B.4.2.1.2 Association Policies

##### B.4.2.1.2.1 General

The DICOM standard application context name for DICOM 3.0 is always proposed:

**Table B.4.2-2  
DICOM APPLICATION CONTEXT FOR AE STORAGE**

|                          |                       |
|--------------------------|-----------------------|
| Application Context Name | 1.2.840.10008.3.1.1.1 |
|--------------------------|-----------------------|

##### B.4.2.1.2.2 Number of Associations

EXAMPLE-INTEGRATED-MODALITY initiates one Association at a time for each destination to which a transfer request is being processed in the active job queue list. Only one job will be active at a time, the other remains pending until the active job is completed or failed.

**Table B.4.2-3  
NUMBER OF ASSOCIATIONS INITIATED FOR AE STORAGE**

|                                             |                  |
|---------------------------------------------|------------------|
| Maximum number of simultaneous Associations | 1 (configurable) |
|---------------------------------------------|------------------|

EXAMPLE-INTEGRATED-MODALITY accepts Associations to receive N-EVENT-REPORT notifications for the Storage Commitment Push Model SOP Class.

**Table B.4.2-4  
NUMBER OF ASSOCIATIONS ACCEPTED FOR AE STORAGE**

|                                             |                  |
|---------------------------------------------|------------------|
| Maximum number of simultaneous Associations | 5 (configurable) |
|---------------------------------------------|------------------|

**B.4.2.1.2.3 Asynchronous Nature**

EXAMPLE-INTEGRATED-MODALITY does not support asynchronous communication (multiple outstanding transactions over a single Association).

**Table B.4.2-5  
ASYNCHRONOUS NATURE AS A SCU FOR AE STORAGE**

|                                                         |   |
|---------------------------------------------------------|---|
| Maximum number of outstanding asynchronous transactions | 1 |
|---------------------------------------------------------|---|

**B.4.2.1.2.4 Implementation Identifying Information**

The implementation information for this Application Entity is:

**Table B.4.2-6  
DICOM IMPLEMENTATION CLASS AND VERSION FOR AE STORAGE**

|                             |                              |
|-----------------------------|------------------------------|
| Implementation Class UID    | 1.xxxxxxx.yyy.etc.ad.inf.usw |
| Implementation Version Name | EXINTMOD_01                  |

**B.4.2.1.3 Association Initiation Policy**

**B.4.2.1.3.1 Activity – Send Images**

**B.4.2.1.3.1.1 Description and Sequencing of Activities**

A user can select images and presentation states and request them to be sent to multiple destinations (up to 3). Each request is forwarded to the job queue and processed individually. When the “Auto-send” option is active, each marked instance or marked set of instances stored in database will be forwarded to the network job queue for a pre-configured auto-send target destination. It can be configured which instances will be automatically marked and the destination where the instances are automatically sent to. The “Auto-send” is triggered by the Close Patient user application.

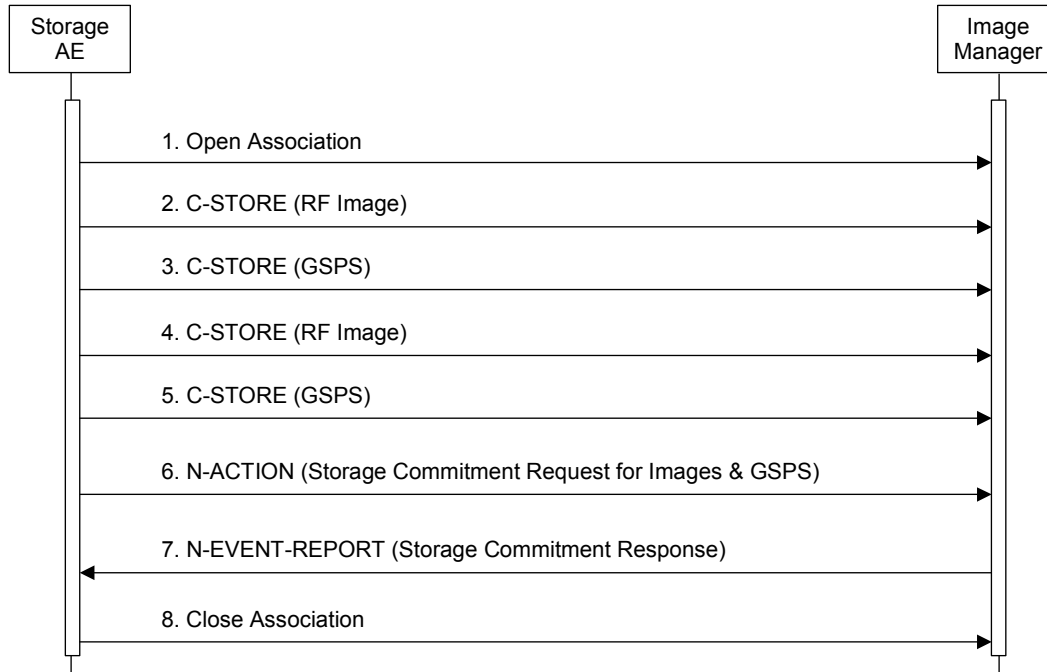
The Storage AE is invoked by the job control interface that is responsible for processing network archival tasks. The job consists of data describing the instances marked for storage and the destination. An internal daemon process triggered by a job for a specific network destination initiates a C-STORE request to store images. If the process successfully establishes an Association to a remote Application Entity, it will transfer each marked instance one after another via the open Association. Status of the transfer is reported through the job control interface. Only one job will be active at a time. If the C-STORE Response from the remote Application contains a status other than Success or Warning, the Association is aborted and the related Job is switched to a failed state. It can be restarted any time by user interaction or, if configured, by automated retry.

The Storage AE attempts to initiate a new Association in order to issue a C-STORE request. If the job contains multiple images then multiple C-STORE requests will be issued over the same Association.

If the Remote AE is configured as an archive device the Storage AE will, after all images and presentation states have been sent, transmit a single Storage Commitment request (N-ACTION) over the same Association. Upon receiving the N-ACTION response the Storage AE will delay releasing the Association for a configurable amount of time. If no N-EVENT-REPORT is received within this time period the Association will be immediately released (i.e. notification of Storage Commitment success or failure will be received over a separate association). However, the Storage AE is capable of receiving an N-EVENT-REPORT request at any time during an association provided a Presentation Context for the Storage Commitment Push Model has been successfully negotiated (i.e. the N-ACTION is sent at the end



of one association and the N-EVENT-REPORT is received during an association initiated for a subsequent send job or during an association initiated by the Remote AE for the specific purpose of sending the N-EVENT-REPORT).



**Figure B.4.2-1**  
**SEQUENCING OF ACTIVITY – SEND IMAGES**

A possible sequence of interactions between the Storage AE and an Image Manager (e.g. a storage or archive device supporting the Storage and Storage Commitment SOP Classes as an SCP) is illustrated in Figure B.4.2-1:

1. The Storage AE opens an association with the Image Manager
2. An acquired RF image is transmitted to the Image Manager using a C-STORE request and the Image Manager replies with a C-STORE response (status success).
3. A GSPS instance is transmitted to the Image Manager using a C-STORE request and the Image Manager replies with a C-STORE response (status success).
4. Another acquired RF image is transmitted to the Image Manager using a C-STORE request and the Image Manager replies with a C-STORE response (status success).
5. Another GSPS instance is transmitted to the Image Manager using a C-STORE request and the Image Manager replies with a C-STORE response (status success).
6. An N-ACTION request is transmitted to the Image Manager to obtain storage commitment of previously transmitted RF images and GSPS instances. The Image Manager replies with a N-ACTION response indicating the request has been received and is being processed.
7. The Image Manager immediately transmits an N-EVENT-REPORT request notifying the Storage AE of the status of the Storage Commitment Request (sent in step 6 using the N-ACTION message). The Storage AE replies with a N-EVENT-REPORT response confirming receipt. The

Image Manager could send this message at any time or omit it entirely in favor of transmitting the N-EVENT-REPORT over a separate dedicated association (see note).

8. The Storage AE closes the association with the Image Manager.

NOTE: Many other message sequences are possible depending on the number of images and GSPS instances to be stored, support for Storage Commitment and when the SCP sends the N-EVENT-REPORT. The N-EVENT-REPORT can also be sent over a separate association initiated by the Image Manager (see Section 4.2.1.4.1 on Activity – Receive Storage Commitment Response).

#### B.4.2.1.3.1.2 Proposed Presentation Contexts

EXAMPLE-INTEGRATED-MODALITY is capable of proposing the Presentation Contexts shown in the following table:

**Table B.4.2-7  
PROPOSED PRESENTATION CONTEXTS FOR ACTIVITY SEND IMAGES**

| Presentation Context Table                    |                    |                           |                     |      |           |
|-----------------------------------------------|--------------------|---------------------------|---------------------|------|-----------|
| Abstract Syntax                               |                    | Transfer Syntax           |                     | Role | Ext. Neg. |
| Name                                          | UID                | Name List                 | UID List            |      |           |
| X-Ray Radio Fluoroscopic Image Storage        | 1.2.840.10008.5.1. | Implicit VR Little Endian | 1.2.840.10008.1.2   | SCU  | None      |
|                                               | 4.1.1.12.2         | Explicit VR Little Endian | 1.2.840.10008.1.2.1 |      |           |
| Grayscale Softcopy Presentation State Storage | 1.2.840.10008.5.1. | Implicit VR Little Endian | 1.2.840.10008.1.2   | SCU  | None      |
|                                               | 4.1.1.11.1         | Explicit VR Little Endian | 1.2.840.10008.1.2.1 |      |           |
| Storage Commitment Push Model                 | 1.2.840.10008.1.20 | Implicit VR Little Endian | 1.2.840.10008.1.2   | SCU  | None      |
|                                               | .1                 | Explicit VR Little Endian | 1.2.840.10008.1.2.1 |      |           |

Presentation Contexts for X-Ray Radio Fluoroscopic Image Storage or Grayscale Softcopy Presentation State Storage will only be proposed if the Send Job contains instances for these SOP Classes.

A Presentation Context for the Storage Commitment Push Model will only be proposed if the Remote AE is configured as an archive device.

#### B.4.2.1.3.1.3 SOP Specific Conformance Image & Pres State Storage SOP Classes

All Image & Presentation State Storage SOP Classes supported by the Storage AE exhibit the same behavior, except where stated, and are described together in this section.

If X-Ray Radio Fluoroscopic Image Storage SOP Instances are included in the Send Job and a corresponding Presentation Context is not accepted then the Association is aborted using AP-ABORT and the send job is marked as failed. The job failure is logged and reported to the user via the job control application.

If Grayscale Softcopy Presentation State Storage SOP Instances are included in the Send Job and a corresponding Presentation Context cannot be negotiated then Grayscale Softcopy Presentation State Storage SOP Instances will not be sent and a warning is logged. Any remaining Image Storage SOP Instances included in the Send Job will be transmitted. Failure to negotiate a Presentation Context for Grayscale Softcopy Presentation State Storage does not in itself cause the Send Job to be marked as failed. The behavior of Storage AE when encountering status codes in a C-STORE response is summarized in the Table below:

**Table B.4.2-8**

- Standard -

**STORAGE C-STORE RESPONSE STATUS HANDLING BEHAVIOR**

| <b>Service Status</b> | <b>Further Meaning</b>            | <b>Error Code</b>      | <b>Behavior</b>                                                                                                                                                                                                       |
|-----------------------|-----------------------------------|------------------------|-----------------------------------------------------------------------------------------------------------------------------------------------------------------------------------------------------------------------|
| Success               | Success                           | 0000                   | The SCP has successfully stored the SOP Instance. If all SOP Instances in a send job have status success then the job is marked as complete.                                                                          |
| Refused               | Out of Resources                  | A700-A7FF              | The Association is aborted using A-ABORT and the send job is marked as failed. The status meaning is logged and the job failure is reported to the user via the job control application. This is a transient failure. |
| Error                 | Data Set does not match SOP Class | A900-A9FF              | The Association is aborted using A-ABORT and the send job is marked as failed. The status meaning is logged and the job failure is reported to the user via the job control application.                              |
| Error                 | Cannot Understand                 | C000-CFFF              | The Association is aborted using A-ABORT and the send job is marked as failed. The status meaning is logged and the job failure is reported to the user via the job control application.                              |
| Warning               | Coercion of Data Elements         | B000                   | Image transmission is considered successful but the status meaning is logged.                                                                                                                                         |
| Warning               | Data Set does not match SOP Class | B007                   | Image transmission is considered successful but the status meaning is logged.                                                                                                                                         |
| Warning               | Elements Discarded                | B006                   | Image transmission is considered successful but the status meaning is logged.                                                                                                                                         |
| *                     | *                                 | Any other status code. | The Association is aborted using A-ABORT and the send job is marked as failed. The status code is logged and the job failure is reported to the user via the job control application.                                 |

The behavior of Storage AE during communication failure is summarized in the Table below:

**Table B.4.2-9  
STORAGE COMMUNICATION FAILURE BEHAVIOR**

| <b>Exception</b>                                 | <b>Behavior</b>                                                                                                                                                                  |
|--------------------------------------------------|----------------------------------------------------------------------------------------------------------------------------------------------------------------------------------|
| Timeout                                          | The Association is aborted using A-ABORT and the send job is marked as failed. The reason is logged and the job failure is reported to the user via the job control application. |
| Association aborted by the SCP or network layers | The send job is marked as failed. The reason is logged and the job failure is reported to the user via the job control application.                                              |

A failed send job can be restarted by user interaction. The system can be configured to automatically resend failed jobs if a transient status code is received. The delay between resending failed jobs and the number of retries is also configurable.

The contents of X-Ray Radio Fluoroscopic Image Storage SOP Instances created by EXAMPLE-INTEGRATED-MODALITY conform to the DICOM X-Ray Radio Fluoroscopic Image IOD definition and are described in section 8.1.

The contents of Grayscale Softcopy Presentation State Storage SOP Instances created by EXAMPLE-INTEGRATED-MODALITY conform to the DICOM Grayscale Softcopy Presentation State IOD and are described in section 8.1.

Grayscale Softcopy Presentation State Storage SOP Instances are created upon user request (e.g. explicitly via “Save” or implicitly via “Close Patient”) in order to save the most recent visual appearance of an image (e.g. window center/width, shutters, graphic annotations). When saving the visual appearance, a default Presentation Label will be supplied which the user can change. The user also has the possibility to enter a detailed Presentation Description. If multiple images from the same study are being displayed the request to save the visual appearance will create one or more Presentation States referencing all displayed images. If images from multiple studies are being displayed at least a separate Presentation State will be created for each study.

When displaying an existing image the most recently saved Grayscale Softcopy Presentation State containing references to the image will be automatically applied. The user has the option to select other Presentation States that also reference the image.

Grayscale Softcopy Presentation State Storage SOP Instances created by EXAMPLE-INTEGRATED-MODALITY will only reference instances of X-Ray Radio Fluoroscopic Image Storage SOP Instances.

Graphical annotations and shutters are only stored in Grayscale Softcopy Presentation State objects. Remote AEs that do not support the Grayscale Softcopy Presentation State Storage SOP Class will not have access to graphical annotations or shutters created by EXAMPLE-INTEGRATED-MODALITY.

**B.4.2.1.3.1.4 SOP Specific Conformance for Storage Commitment SOP Class**

**B.4.2.1.3.1.4.1 Storage Commitment Operations (N-ACTION)**

The Storage AE will request storage commitment for instances of the X-Ray Radio Fluoroscopic Image Storage SOP Class and Grayscale Softcopy Presentation State Storage SOP Class if the Remote AE is configured as an archive device and a presentation context for the Storage Commitment Push Model has been accepted.

The Storage AE will consider Storage Commitment failed if no N-EVENT-REPORT is received for a Transaction UID within a configurable time period after receiving a successful N-ACTION response (duration of applicability for a Transaction UID).

The Storage AE does not send the optional Storage Media FileSet ID & UID Attributes or the Referenced Study Component Sequence Attribute in the N-ACTION

The behavior of Storage AE when encountering status codes in a N-ACTION response is summarized in the Table below:

**Table B.4.2-10  
STORAGE COMMITMENT N-ACTION RESPONSE STATUS HANDLING BEHAVIOR**

| <b>Service Status</b> | <b>Further Meaning</b> | <b>Error Code</b>      | <b>Behavior</b>                                                                                                                                                                                      |
|-----------------------|------------------------|------------------------|------------------------------------------------------------------------------------------------------------------------------------------------------------------------------------------------------|
| Success               | Success                | 0000                   | The request for storage comment is considered successfully sent. A timer is started which will expire if no N-EVENT-REPORT for the Transaction UID is received within a configurable timeout period. |
| *                     | *                      | Any other status code. | The Association is aborted using A-ABORT and the request for storage comment is marked as failed. The status meaning is logged and reported to the user.                                             |

The behavior of Storage AE during communication failure is summarized in the Table below:

**Table B.4.2-11  
STORAGE COMMITMENT COMMUNICATION FAILURE BEHAVIOR**

| Exception                                        | Behavior                                                                                                                                                                         |
|--------------------------------------------------|----------------------------------------------------------------------------------------------------------------------------------------------------------------------------------|
| Timeout                                          | The Association is aborted using A-ABORT and the send job is marked as failed. The reason is logged and the job failure is reported to the user via the job control application. |
| Association aborted by the SCP or network layers | The send job is marked as failed. The reason is logged and the job failure is reported to the user via the job control application.                                              |

#### B.4.2.1.3.1.4.2 Storage Commitment Notifications (N-EVENT-REPORT)

The Storage AE is capable of receiving an N-EVENT-REPORT notification if it has successfully negotiated a Presentation Context for the Storage Commitment Push Model (i.e. only associations established with archive devices).

Upon receipt of a N-EVENT-REPORT the timer associated with the Transaction UID will be canceled.

The behavior of Storage AE when receiving Event Types within the N-EVENT-REPORT is summarized in the Table below.

**Table B.4.2-12  
STORAGE COMMITMENT N-EVENT-REPORT BEHAVIOUR**

| Event Type Name                                      | Event Type ID | Behavior                                                                                                                                                                                                                                                                                                                                                                                                                                                                                                                                                                   |
|------------------------------------------------------|---------------|----------------------------------------------------------------------------------------------------------------------------------------------------------------------------------------------------------------------------------------------------------------------------------------------------------------------------------------------------------------------------------------------------------------------------------------------------------------------------------------------------------------------------------------------------------------------------|
| Storage Commitment Request Successful                | 1             | The Referenced SOP Instances under Referenced SOP Sequence (0008,1199) are marked within the database as "Stored & Committed (SC)" to the value of Retrieve AE Title (0008,0054). Successfully committed SOP Instances are candidates for automatic deletion from the local database if local resources become scarce. The conditions under which automatic deletion is initiated and the amount of space freed are site configurable. SOP Instances will not be deleted if they are marked with a lock flag. The least recently accessed SOP Instances are deleted first. |
| Storage Commitment Request Complete – Failures Exist | 2             | The Referenced SOP Instances under Referenced SOP Sequence (0008,1199) are treated in the same way as in the success case (Event Type 1). The Referenced SOP Instances under Failed SOP Sequence (0008,1198) are marked within the database as "Store & Commit Failed (Sf)". The Failure Reasons are logged and the job failure is reported to the user via the job control application. A send job that failed storage commitment will not be automatically restarted but can be restarted by user interaction.                                                           |

The reasons for returning specific status codes in a N-EVENT-REPORT response are summarized in the Table below.

**Table B.4.2-13  
STORAGE COMMITMENT N-EVENT-REPORT RESPONSE STATUS REASONS**

| Service Status | Further Meaning        | Error Code | Reasons                                                                                                            |
|----------------|------------------------|------------|--------------------------------------------------------------------------------------------------------------------|
| Success        | Success                | 0000       | The storage commitment result has been successfully received.                                                      |
| Failure        | Unrecognized Operation | 0211H      | The Transaction UID in the N-EVENT-REPORT request is not recognized (was never issued within an N-ACTION request). |

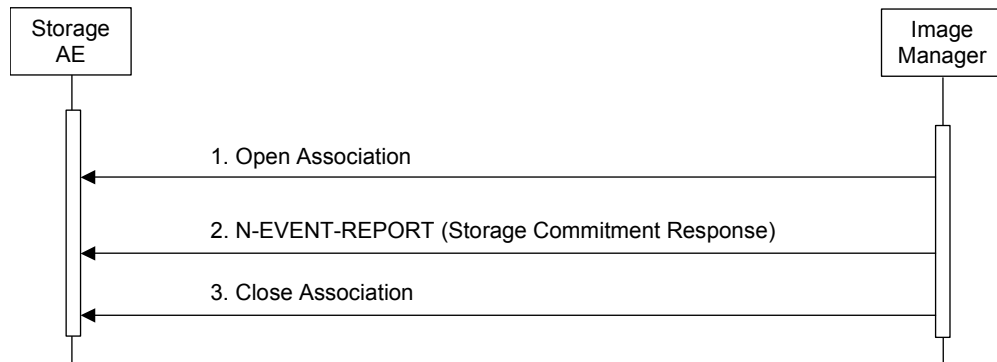
|         |                        |       |                                                                                                                                                                                                                                                                                                                         |
|---------|------------------------|-------|-------------------------------------------------------------------------------------------------------------------------------------------------------------------------------------------------------------------------------------------------------------------------------------------------------------------------|
| Failure | Resource Limitation    | 0213H | The Transaction UID in the N-EVENT-REPORT request has expired (no N-EVENT-REPORT was received within a configurable time limit).                                                                                                                                                                                        |
| Failure | No Such Event Type     | 0113H | An invalid Event Type ID was supplied in the N-EVENT-REPORT request.                                                                                                                                                                                                                                                    |
| Failure | Processing Failure     | 0110H | An internal error occurred during processing of the N-EVENT-REPORT. A short description of the error will be returned in Error Comment (0000,0902).                                                                                                                                                                     |
| Failure | Invalid Argument Value | 0115H | One or more SOP Instance UIDs with the Referenced SOP Sequence (0008,1199) or Failed SOP Sequence (0008,1198) was not included in the Storage Commitment Request associated with this Transaction UID. The unrecognized SOP Instance UIDs will be returned within the Event Information of the N-EVENT-REPORT response. |

**B.4.2.1.4 Association Acceptance Policy**

**B.4.2.1.4.1 Activity – Receive Storage Commitment Response**

**B.4.2.1.4.1.1 Description and Sequencing of Activities**

The Storage AE will accept associations in order to receive responses to a Storage Commitment Request.



**Figure B.4.2-2  
SEQUENCING OF ACTIVITY - RECEIVE STORAGE COMMITMENT RESPONSE**

A possible sequence of interactions between the Storage AE and an Image Manager (e.g. a storage or archive device supporting Storage Commitment SOP Classes as an SCP) is illustrated in the Figure above:

1. The Image Manager opens a new association with the Storage AE.
2. The Image Manager sends an N-EVENT-REPORT request notifying the Storage AE of the status of a previous Storage Commitment Request. The Storage AE replies with a N-EVENT-REPORT response confirming receipt.
3. The Image Manager closes the association with the Storage AE.

The Storage AE may reject association attempts as shown in the Table below. The Result, Source and Reason/Diag columns represent the values returned in the appropriate fields of an ASSOCIATE-RJ PDU

(see PS 3.8, Section 9.3.4). The contents of the Source column is abbreviated to save space and the meaning of the abbreviations are:

- a) 1 – DICOM UL service-user
- b) 2 – DICOM UL service-provider (ASCE related function)
- c) 3 – DICOM UL service-provider (Presentation related function)

**Table B.4.2-14**  
**ASSOCIATION REJECTION REASONS**

| <b>Result</b>          | <b>Source</b> | <b>Reason/Diag</b>                         | <b>Explanation</b>                                                                                                                                                                                                                                                                                                                                                   |
|------------------------|---------------|--------------------------------------------|----------------------------------------------------------------------------------------------------------------------------------------------------------------------------------------------------------------------------------------------------------------------------------------------------------------------------------------------------------------------|
| 2 – rejected-transient | c             | 2 – local-limit-exceeded                   | The (configurable) maximum number of simultaneous associations has been reached. An association request with the same parameters may succeed at a later time.                                                                                                                                                                                                        |
| 2 – rejected-transient | c             | 1 – temporary-congestion                   | No associations can be accepted at this time due to the real-time requirements of higher priority activities (e.g. during image acquisition no associations will be accepted) or because insufficient resources are available (e.g. memory, processes, threads). An association request with the same parameters may succeed at a later time.                        |
| 1 – rejected-permanent | a             | 2 – application-context-name-not-supported | The association request contained an unsupported Application Context Name. An association request with the same parameters will not succeed at a later time.                                                                                                                                                                                                         |
| 1 – rejected-permanent | a             | 7 – called-AE-title-not-recognized         | The association request contained an unrecognized Called AE Title. An association request with the same parameters will not succeed at a later time unless configuration changes are made. This rejection reason normally occurs when the association initiator is incorrectly configured and attempts to address the association acceptor using the wrong AE Title. |
| 1 – rejected-permanent | a             | 3 – calling-AE-title-not-recognized        | The association request contained an unrecognized Calling AE Title. An association request with the same parameters will not succeed at a later time unless configuration changes are made. This rejection reason normally occurs when the association acceptor has not been configured to recognize the AE Title of the association initiator.                      |
| 1 – rejected-permanent | b             | 1 – no-reason-given                        | The association request could not be parsed. An association request with the same format will not succeed at a later time.                                                                                                                                                                                                                                           |

**B.4.2.1.4.1.2 Accepted Presentation Contexts**

The Storage AE will accept Presentation Contexts as shown in the Table below.

**Table B.4.2-15**  
**ACCEPTABLE PRESENTATION CONTEXTS FOR**  
**ACTIVITY RECEIVE STORAGE COMMITMENT RESPONSE**

| Presentation Context Table    |                      |                           |                     |      |           |
|-------------------------------|----------------------|---------------------------|---------------------|------|-----------|
| Abstract Syntax               |                      | Transfer Syntax           |                     | Role | Ext. Neg. |
| Name                          | UID                  | Name List                 | UID List            |      |           |
| Storage Commitment Push Model | 1.2.840.10008.1.20.1 | Implicit VR Little Endian | 1.2.840.10008.1.2   | SCU  | None      |
|                               |                      | Explicit VR Little Endian | 1.2.840.10008.1.2.1 |      |           |
| Verification                  | 1.2.840.10008.1.1    | Implicit VR Little Endian | 1.2.840.10008.1.2   | SCP  | None      |
|                               |                      | Explicit VR Little Endian | 1.2.840.10008.1.2.1 |      |           |

The Storage AE will prefer to select the Explicit VR Little Endian Transfer Syntax if multiple transfer syntaxes are offered. The Storage AE will only accept the SCU role (which must be proposed via SCP/SCU Role Selection Negotiation) within a Presentation Context for the Storage Commitment Push Model SOP Class.

**B.4.2.1.4.1.3 SOP Specific Conformance for Storage Commitment SOP Class**

**B.4.2.1.4.1.3.1 Storage Commitment Notifications (N-EVENT-REPORT)**

Upon receipt of a N-EVENT-REPORT the timer associated with the Transaction UID will be canceled.

The behavior of Storage AE when receiving Event Types within the N-EVENT-REPORT is summarized in Table B.4.2-12.

The reasons for returning specific status codes in a N-EVENT-REPORT response are summarized in Table B.4.2-13.

**B.4.2.1.4.1.4 SOP Specific Conformance for Verification SOP Class**

The Storage AE provides standard conformance to the Verification SOP Class as an SCP. If the C-ECHO request was successfully received, a 0000 (Success) status code will be returned in the C-ECHO response. Otherwise, a C000 (Error – Cannot Understand) status code will be returned in the C-ECHO response.

**B.4.2.2 Workflow Application Entity Specification**

**B.4.2.2.1 SOP Classes**

EXAMPLE-INTEGRATED-MODALITY provides Standard Conformance to the following SOP Classes:

**Table B.4.2-16  
SOP CLASSES FOR AE WORKFLOW**

| SOP Class Name                             | SOP Class UID           | SCU | SCP |
|--------------------------------------------|-------------------------|-----|-----|
| Modality Worklist Information Model – FIND | 1.2.840.10008.5.1.4.31  | Yes | No  |
| Modality Performed Procedure Step          | 1.2.840.10008.3.1.2.3.3 | Yes | No  |

**B.4.2.2.2 Association Policies**

**B.4.2.2.2.1 General**

The DICOM standard application context name for DICOM 3.0 is always proposed:



**Table B.4.2-17  
DICOM APPLICATION CONTEXT FOR AE WORKFLOW**

|                          |                       |
|--------------------------|-----------------------|
| Application Context Name | 1.2.840.10008.3.1.1.1 |
|--------------------------|-----------------------|

**B.4.2.2.2 Number of Associations**

EXAMPLE-INTEGRATED-MODALITY initiates one Association at a time for a Worklist request.

**Table B.4.2-18  
NUMBER OF ASSOCIATIONS INITIATED FOR AE WORKFLOW**

|                                             |   |
|---------------------------------------------|---|
| Maximum number of simultaneous Associations | 1 |
|---------------------------------------------|---|

**B.4.2.2.3 Asynchronous Nature**

EXAMPLE-INTEGRATED-MODALITY does not support asynchronous communication (multiple outstanding transactions over a single Association).

**Table B.4.2-19  
ASYNCHRONOUS NATURE AS A SCU FOR AE WORKFLOW**

|                                                         |   |
|---------------------------------------------------------|---|
| Maximum number of outstanding asynchronous transactions | 1 |
|---------------------------------------------------------|---|

**B.4.2.2.4 Implementation Identifying Information**

The implementation information for this Application Entity is:

**Table B.4.2-20  
DICOM IMPLEMENTATION CLASS AND VERSION FOR AE WORKFLOW**

|                             |                              |
|-----------------------------|------------------------------|
| Implementation Class UID    | 1.xxxxxxx.yyy.etc.ad.inf.usw |
| Implementation Version Name | EXINTMOD_01                  |

**B.4.2.2.3 Association Initiation Policy**

**B.4.2.2.3.1 Activity – Worklist Update**

**B.4.2.2.3.1.1 Description and Sequencing of Activities**

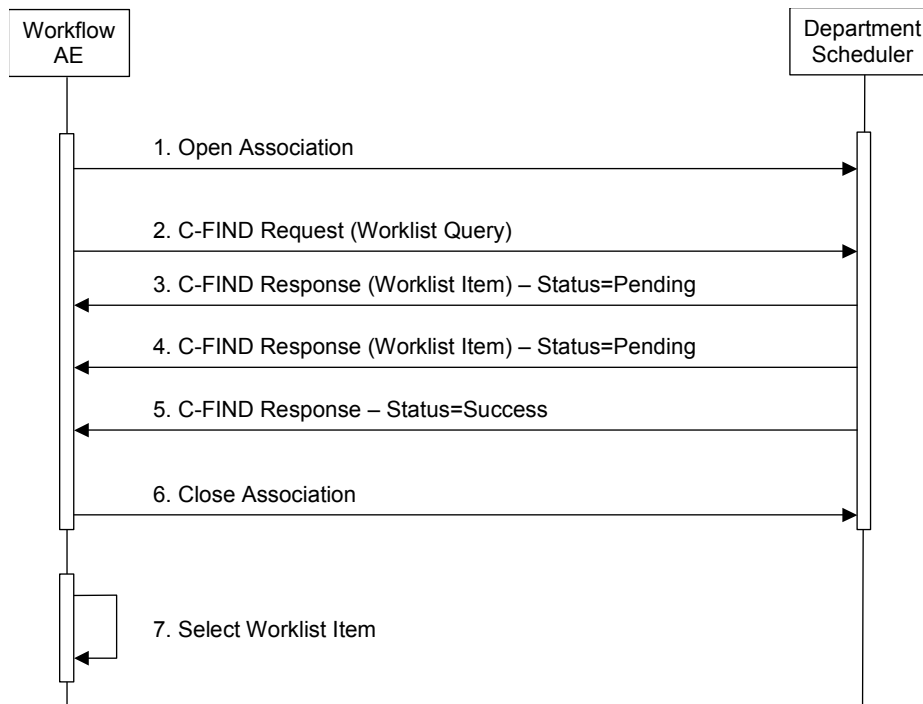
The request for a Worklist Update is initiated by user interaction, i.e. pressing the buttons “Worklist Update”/“Patient Worklist Query” or automatically at specific time intervals, configurable by the user. With “Worklist Update” the automated query mechanism is performed immediately on request, while with “Patient Worklist Query” a dialog to enter search criteria is opened and an interactive query can be performed.

The interactive Patient Worklist Query will display a dialog for entering data as search criteria. When the Query is started on user request, only the data from the dialog will be inserted as matching keys into the query.

With automated worklist queries (including “Worklist Update”) the EXAMPLE-INTEGRATED-MODALITY always requests all items for a Scheduled Procedure Step Start Date (actual date), Modality (RF) and Scheduled Station AE Title. Query for the Scheduled Station AE Title is configurable by a Service Engineer.

Upon initiation of the request, the EXAMPLE-INTEGRATED-MODALITY will build an Identifier for the C-FIND request, will initiate an Association to send the request and will wait for Worklist responses. After retrieval of all responses, EXAMPLE-INTEGRATED-MODALITY will access the local database to add or update patient demographic data. To protect the system from overflow, the EXAMPLE-INTEGRATED-MODALITY will limit the number of processed worklist responses to a configurable maximum. During receiving the worklist response items are counted and the query processing is canceled by issuing a C-FIND-CANCEL if the configurable limit of items is reached. The results will be displayed in a separate list, which will be cleared with the next worklist update.

EXAMPLE-INTEGRATED-MODALITY will initiate an Association in order to issue a C-FIND request according to the Modality Worklist Information Model.



**Figure B.4.2-3**  
**SEQUENCING OF ACTIVITY – WORKLIST UPDATE**

A possible sequence of interactions between the Workflow AE and a Departmental Scheduler (e.g. a device such as a RIS or HIS which supports the Modality Worklist SOP Class as an SCP) is illustrated in the Figure above:

1. The Worklist AE opens an association with the Departmental Scheduler
2. The Worklist AE sends a C-FIND request to the Departmental Scheduler containing the Worklist Query attributes.
3. The Departmental Scheduler returns a C-FIND response containing the requested attributes of the first matching Worklist Item.
4. The Departmental Scheduler returns another C-FIND response containing the requested attributes of the second matching Worklist Item.

5. The Departmental Scheduler returns another C-FIND response with status Success indicating that no further matching Worklist Items exist. This example assumes that only 2 Worklist items match the Worklist Query.
6. The Worklist AE closes the association with the Departmental Scheduler.
7. The user selects a Worklist Item from the Worklist and prepares to acquire new images.

**B.4.2.2.3.1.2 Proposed Presentation Contexts**

EXAMPLE-INTEGRATED-MODALITY will propose Presentation Contexts as shown in the following table:

**Table B.4.2-21  
PROPOSED PRESENTATION CONTEXTS FOR ACTIVITY WORKLIST UPDATE**

| Presentation Context Table                 |                        |                           |                     |      |           |
|--------------------------------------------|------------------------|---------------------------|---------------------|------|-----------|
| Abstract Syntax                            |                        | Transfer Syntax           |                     | Role | Ext. Neg. |
| Name                                       | UID                    | Name List                 | UID List            |      |           |
| Modality Worklist Information Model – FIND | 1.2.840.10008.5.1.4.31 | Implicit VR Little Endian | 1.2.840.10008.1.2   | SCU  | None      |
|                                            |                        | Explicit VR Little Endian | 1.2.840.10008.1.2.1 |      |           |

**B.4.2.2.3.1.3 SOP Specific Conformance for Modality Worklist**

The behavior of EXAMPLE-INTEGRATED-MODALITY when encountering status codes in a Modality Worklist C-FIND response is summarized in the Table below. If any other SCP response status than "Success" or "Pending" is received by EXAMPLEINTEGRATED-MODALITY, a message "query failed" will appear on the user interface.

**Table B.4.2-22  
MODALITY WORKLIST C-FIND RESPONSE STATUS HANDLING BEHAVIOR**

| Service Status | Further Meaning                           | Error Code  | Behavior                                                                                                                                                                                                                                                                                                                                        |
|----------------|-------------------------------------------|-------------|-------------------------------------------------------------------------------------------------------------------------------------------------------------------------------------------------------------------------------------------------------------------------------------------------------------------------------------------------|
| Success        | Matching is complete                      | 0000        | The SCP has completed the matches. Worklist items are available for display or further processing.                                                                                                                                                                                                                                              |
| Refused        | Out of Resources                          | A700        | The Association is aborted using A-ABORT and the worklist query is marked as failed. The status meaning is logged and reported to the user if an interactive query. Any additional error information in the Response will be logged.                                                                                                            |
| Failed         | Identifier does not match SOP Class       | A900        | The Association is aborted using A-ABORT and the worklist query is marked as failed. The status meaning is logged and reported to the user if an interactive query. Any additional error information in the Response will be logged.                                                                                                            |
| Failed         | Unable to Process                         | C000 – CFFF | The Association is aborted using A-ABORT and the worklist query is marked as failed. The status meaning is logged and reported to the user if an interactive query. Any additional error information in the Response will be logged.                                                                                                            |
| Cancel         | Matching terminated due to Cancel request | FE00        | If the query was cancelled due to too may worklist items then the SCP has completed the matches. Worklist items are available for display or further processing. Otherwise, the Association is aborted using A-ABORT and the worklist query is marked as failed. The status meaning is logged and reported to the user if an interactive query. |

|         |                                                                                    |                        |                                                                                                                                                                                                                                |
|---------|------------------------------------------------------------------------------------|------------------------|--------------------------------------------------------------------------------------------------------------------------------------------------------------------------------------------------------------------------------|
| Pending | Matches are continuing                                                             | FF00                   | The worklist item contained in the Identifier is collected for later display or further processing.                                                                                                                            |
| Pending | Matches are continuing – Warning that one or more Optional Keys were not supported | FF01                   | The worklist item contained in the Identifier is collected for later display or further processing. The status meaning is logged only once for each C-FIND operation.                                                          |
| *       | *                                                                                  | Any other status code. | The Association is aborted using A-ABORT and the worklist is marked as failed. The status meaning is logged and reported to the user if an interactive query. Any additional error information in the Response will be logged. |

The behavior of EXAMPLE-INTEGRATED-MODALITY during communication failure is summarized in the Table below.

**Table B4.2-23  
MODALITY WORKLIST COMMUNICATION FAILURE BEHAVIOR**

| Exception                                        | Behavior                                                                                                                                                 |
|--------------------------------------------------|----------------------------------------------------------------------------------------------------------------------------------------------------------|
| Timeout                                          | The Association is aborted using A-ABORT and the worklist query marked as failed. The reason is logged and reported to the user if an interactive query. |
| Association aborted by the SCP or network layers | The worklist query is marked as failed. The reason is logged and reported to the user if an interactive query.                                           |

Acquired images will always use the Study Instance UID specified for the Scheduled Procedure Step (if available). If an acquisition is unscheduled, a Study Instance UID will be generated locally.

The Table below provides a description of the EXAMPLEINTEGRATED-MODALITY Worklist Request Identifier and specifies the attributes that are copied into the images. Unexpected attributes returned in a C-FIND response are ignored.

Requested return attributes not supported by the SCP are set to have no value. Non-matching responses returned by the SCP due to unsupported optional matching keys are ignored. No attempt is made to filter out possible duplicate entries.

**Table B.4.2-24  
WORKLIST REQUEST IDENTIFIER**

| Module Name<br>Attribute Name        | Tag         | VR | M | R | Q | D | IOD |
|--------------------------------------|-------------|----|---|---|---|---|-----|
| SOP Common<br>Specific Character Set | (0008,0005) | CS |   | x |   |   |     |

|                                            |             |    |     |   |   |   |   |
|--------------------------------------------|-------------|----|-----|---|---|---|---|
| Scheduled Procedure Step                   |             |    |     |   |   |   |   |
| Scheduled Procedure Step Sequence          | (0040,0100) | SQ |     | x |   |   |   |
| > Scheduled Station AET                    | (0040,0001) | AE | (S) |   |   | x |   |
| > Scheduled Procedure Step Start Date      | (0040,0002) | DA | S   |   |   | x |   |
| > Scheduled Procedure Step Start Time      | (0040,0003) | TM |     | x |   | x |   |
| > Modality                                 | (0008,0060) | CS | S   | x |   |   |   |
| > Scheduled Performing Physician's Name    | (0040,0006) | PN |     | x | x | x | x |
| > Scheduled Procedure Step Description     | (0040,0007) | LO |     | x |   | x | x |
| > Scheduled Station Name                   | (0040,0010) | SH |     | x |   |   |   |
| > Scheduled Procedure Step Location        | (0040,0011) | SH |     | x |   |   |   |
| > Scheduled Protocol Code Sequence         | (0040,0008) | SQ |     | x |   |   | x |
| > Pre-Medication                           | (0040,0012) | LO |     | x |   | x |   |
| > Scheduled Procedure Step ID              | (0040,0009) | SH |     | x |   | x | x |
| > Requested Contrast Agent                 | (0032,1070) | LO |     | x |   | x |   |
| Requested Procedure                        |             |    |     |   |   |   |   |
| Requested Procedure ID                     | (0040,1001) | SH |     | x | x | x | x |
| Requested Procedure Description            | (0032,1060) | LO |     | x |   | x | x |
| Study Instance UID                         | (0020,000D) | UI |     | x |   |   | x |
| Requested Procedure Priority               | (0040,1003) | SH |     | x |   |   |   |
| Patient Transport Arrangements             | (0040,1004) | LO |     | x |   |   |   |
| Referenced Study Sequence                  | (0008,1110) | SQ |     | x |   |   | x |
| Requested Procedure Code Sequence          | (0032,1064) | SQ |     | x |   |   | x |
| Imaging Service Request                    |             |    |     |   |   |   |   |
| Accession Number                           | (0008,0050) | SH |     | x | x | x | x |
| Requesting Physician                       | (0032,1032) | PN |     | x |   | x | x |
| Referring Physician's Name                 | (0008,0090) | PN |     | x | x | x | x |
| Visit Identification                       |             |    |     |   |   |   |   |
| Admission ID                               | (0038,0010) | LO |     | x |   |   |   |
| Visit Status                               |             |    |     |   |   |   |   |
| Current Patient Location                   | (0038,0300) | LO |     | x | x |   |   |
| Visit Admission                            |             |    |     |   |   |   |   |
| Admitting Diagnosis Description            | (0008,1080) | LO |     | x |   | x |   |
| Patient Identification                     |             |    |     |   |   |   |   |
| Patient Name                               | (0010,0010) | PN |     | x | x | x | x |
| Patient ID                                 | (0010,0020) | LO |     | x | x | x | x |
| Patient Demographic                        |             |    |     |   |   |   |   |
| Patient's Birth Date                       | (0010,0030) | DA |     | x | x | x | x |
| Patient's Sex                              | (0010,0040) | CS |     | x | x | x | x |
| Patient's Weight                           | (0010,1030) | DS |     | x |   | x | x |
| Confidentiality constraint on patient data | (0040,3001) | LO |     | x |   | x |   |
| Patient Medical                            |             |    |     |   |   |   |   |
| Patient State                              | (0038,0500) | LO |     | x |   | x |   |
| Pregnancy Status                           | (0010,21C0) | US |     | x |   | x |   |
| Medical Alerts                             | (0010,2000) | LO |     | x |   | x |   |
| Allergies                                  | (0010,2110) | LO |     | x |   | x |   |
| Special Needs                              | (0038,0050) | LO |     | x |   | x |   |

The above table should be read as follows:

Module Name: The name of the associated module for supported worklist attributes.

Attribute Name: Attributes supported to build an EXAMPLEINTEGRATED-MODALITY Worklist Request Identifier.

- Tag: DICOM tag for this attribute.
- VR: DICOM VR for this attribute.
- M: Matching keys for (automatic) Worklist Update. A "S" will indicate that EXAMPLE-INTEGRATED-MODALITY will supply an attribute value for Single Value Matching, a "R" will indicate Range Matching and a "\*" will denote wildcard matching. It can be configured if "Scheduled Station AE Title" is additionally supplied "(S)" and if Modality is set to RF or SC.
- R: Return keys. An "x" will indicate that EXAMPLE-INTEGRATED-MODALITY will supply this attribute as Return Key with zero length for Universal Matching. The EXAMPLE-INTEGRATED-MODALITY will support retired date format (yyyy.mm.dd) for "Patient's Birth Date" and "Scheduled Procedure Step Start Date" in the response identifiers. For "Scheduled Procedure Step Start Time" also retired time format as well as unspecified time components are supported.
- Q: Interactive Query Key. An "x" will indicate that EXAMPLE-INTEGRATED-MODALITY will supply this attribute as matching key, if entered in the Query Patient Worklist dialog. For example, the Patient Name can be entered thereby restricting Worklist responses to Procedure Steps scheduled for the patient.
- D: Displayed keys. An "x" indicates that this worklist attribute is displayed to the user during a patient registration dialog. For example, Patient Name will be displayed when registering the patient prior to an examination.
- IOD: An "x" indicates that this Worklist attribute is included into all Object Instances created during performance of the related Procedure Step.

The default Query Configuration is set to "Modality" (RF) and "Date" (date of today). Optionally, additional matching for the own AET is configurable.

#### **B.4.2.2.3.2 Activity – Acquire Images**

##### **B.4.2.2.3.2.1 Description and Sequencing of Activities**

After Patient registration, the EXAMPLE-INTEGRATED-MODALITY is awaiting the 1st application of X-Ray Dose to the patient. The trigger to create a MPPS SOP Instance is derived from this event. An Association to the configured MPPS SCP system is established immediately and the related MPPS SOP Instance will be created.

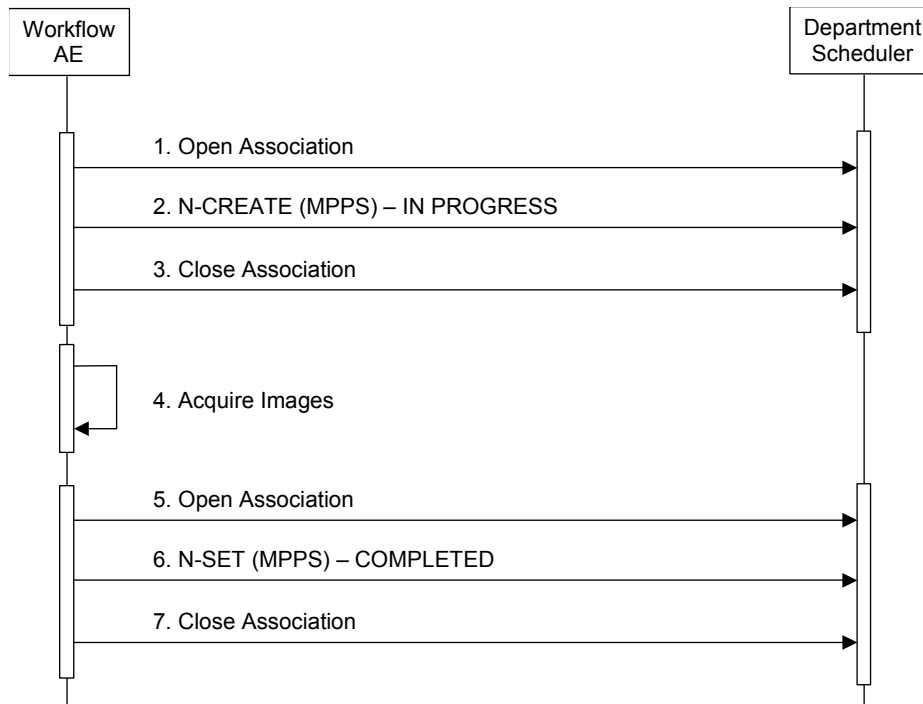
A manual update can be performed with the MPPS user interface where is it possible to set the final state of the MPPS to "COMPLETED" or "DISCONTINUED". In the "Discontinued" case the user can also select the discontinuation reason from a list corresponding to Context Group 9300. A MPPS Instance that has been sent with a state of "COMPLETED" or "DISCONTINUED" can no longer be updated.

The EXAMPLE-INTEGRATED-MODALITY will support creation of "unscheduled cases" by allowing MPPS Instances to be communicated for locally registered Patients.

The EXAMPLE-INTEGRATED-MODALITY only supports a 0-to-1 relationship between Scheduled and Performed Procedure Steps.

EXAMPLE-INTEGRATED-MODALITY will initiate an Association to issue an:

- N-CREATE request according to the CREATE Modality Performed Procedure Step SOP Instance operation or a
- N-SET request to update the contents and state of the MPPS according to the SET Modality Performed Procedure Step Information operation.



**Figure B.4.2-4  
SEQUENCING OF ACTIVITY – ACQUIRE IMAGES**

A possible sequence of interactions between the Workflow AE and a Departmental Scheduler (e.g. a device such as a RIS or HIS which supports the MPPS SOP Class as an SCP) is illustrated in Figure B.4.2-4:

1. The Worklist AE opens an association with the Departmental Scheduler
2. The Worklist AE sends an N-CREATE request to the Departmental Scheduler to create an MPPS instance with status of "IN PROGRESS" and create all necessary attributes. The Departmental Scheduler acknowledges the MPPS creation with an N-CREATE response (status success).
3. The Worklist AE closes the association with the Departmental Scheduler.
4. All images are acquired and stored in the local database.
5. The Worklist AE opens an association with the Departmental Scheduler.
6. The Worklist AE sends an N-SET request to the Departmental Scheduler to update the MPPS instance with status of "COMPLETED" and set all necessary attributes. The Departmental Scheduler acknowledges the MPPS update with an N-SET response (status success).
7. The Worklist AE closes the association with the Departmental Scheduler.

**B.4.2.2.3.2.2 Proposed Presentation Contexts**

EXAMPLE-INTEGRATED-MODALITY will propose Presentation Contexts as shown in the following table:

**Table B.4.2-25  
PROPOSED PRESENTATION CONTEXTS FOR REAL-WORLD ACTIVITY ACQUIRE IMAGES**

- Standard -

| Presentation Context Table        |                         |                           |                     |      |           |
|-----------------------------------|-------------------------|---------------------------|---------------------|------|-----------|
| Abstract Syntax                   |                         | Transfer Syntax           |                     | Role | Ext. Neg. |
| Name                              | UID                     | Name List                 | UID List            |      |           |
| Modality Performed Procedure Step | 1.2.840.10008.3.1.2.3.3 | Implicit VR Little Endian | 1.2.840.10008.1.2   | SCU  | None      |
|                                   |                         | Explicit VR Little Endian | 1.2.840.10008.1.2.1 |      |           |

**B.4.2.2.3.2.3 SOP Specific Conformance for MPPS**

The behavior of EXAMPLE-INTEGRATED-MODALITY when encountering status codes in an MPPS N-CREATE or N-SET response is summarized in Table B.4.2-26. If any other SCP response status than "Success" or "Warning" is received by EXAMPLEINTEGRATED-MODALITY, a message "MPPS update failed" will appear on the user interface.

**Table 4.2-26  
MPPS N-CREATE / N-SET RESPONSE STATUS HANDLING BEHAVIOR**

| Service Status | Further Meaning                                                               | Error Code             | Behavior                                                                                                                                                                                                                            |
|----------------|-------------------------------------------------------------------------------|------------------------|-------------------------------------------------------------------------------------------------------------------------------------------------------------------------------------------------------------------------------------|
| Success        | Success                                                                       | 0000                   | The SCP has completed the operation successfully.                                                                                                                                                                                   |
| Failure        | Processing Failure – Performed Procedure Step Object may no longer be updated | 0110                   | The Association is aborted using A-ABORT and the MPPS is marked as failed. The status meaning is logged and reported to the user. Additional information in the Response will be logged (i.e. Error Comment and Error ID).          |
| Warning        | Attribute Value Out of Range                                                  | 0116H                  | The MPPS operation is considered successful but the status meaning is logged. Additional information in the Response identifying the attributes out of range will be logged (i.e. Elements in the Modification List/Attribute List) |
| *              | *                                                                             | Any other status code. | The Association is aborted using A-ABORT and the MPPS is marked as failed. The status meaning is logged and reported to the user.                                                                                                   |

The behavior of EXAMPLE-INTEGRATED-MODALITY during communication failure is summarized in the Table below:

**Table B.4.2-27  
MPPS COMMUNICATION FAILURE BEHAVIOR**

| Exception                                        | Behavior                                                                                                           |
|--------------------------------------------------|--------------------------------------------------------------------------------------------------------------------|
| Timeout                                          | The Association is aborted using A-ABORT and MPPS marked as failed. The reason is logged and reported to the user. |
| Association aborted by the SCP or network layers | The MPPS is marked as failed. The reason is logged and reported to the user.                                       |

Table B.4.2-28 provides a description of the MPPS N-CREATE and N-SET request identifiers sent by EXAMPLE-INTEGRATED-MODALITY. Empty cells in the N-CREATE and N-SET columns indicate that the attribute is not sent. An "x" indicates that an appropriate value will be sent. A "Zero length" attribute will be sent with zero length.



**Table B.4.2-28**  
**MPPS N-CREATE / N-SET REQUEST IDENTIFIER**

| Attribute Name                      | Tag         | VR | N-CREATE                                                                                                            | N-SET                     |
|-------------------------------------|-------------|----|---------------------------------------------------------------------------------------------------------------------|---------------------------|
| Specific Character Set              | (0008,0005) | CS | "ISO_IR 100" or "ISO_IR 144"                                                                                        |                           |
| Modality                            | (0008,0060) | CS | RF                                                                                                                  |                           |
| Referenced Patient Sequence         | (0008,1120) | SQ | Zero length                                                                                                         |                           |
| Patient's Name                      | (0010,0010) | PN | From Modality Worklist or user input (all 5 components). The user can modify values provided via Modality Worklist. |                           |
| Patient ID                          | (0010,0020) | LO | From Modality Worklist or user input. The user can modify values provided via Modality Worklist.                    |                           |
| Patient's Birth Date                | (0010,0030) | DA | From Modality Worklist or user input. The user can modify values provided via Modality Worklist.                    |                           |
| Patient's Sex                       | (0010,0040) | CS | From Modality Worklist or user input. The user can modify values provided via Modality Worklist.                    |                           |
| Distance Source to Detector (SID)   | (0018,1110) | DS | Zero length                                                                                                         | x                         |
| Image Area Dose Product             | (0018,115E) | DS | Zero length                                                                                                         | x                         |
| Study ID                            | (0020,0010) | SH | From Modality Worklist or user input. The user can modify values provided via Modality Worklist.                    |                           |
| Performed Station AE Title          | (0040,0241) | AE | MPPS AE Title                                                                                                       |                           |
| Performed Station Name              | (0040,0242) | SH | From configuration                                                                                                  |                           |
| Performed Location                  | (0040,0243) | SH | From configuration                                                                                                  |                           |
| Performed Procedure Step Start Date | (0040,0244) | DA | Actual start date                                                                                                   |                           |
| Performed Procedure Step Start Time | (0040,0245) | TM | Actual start time                                                                                                   |                           |
| Performed Procedure Step End Date   | (0040,0250) | DA | Zero length                                                                                                         | Actual end date           |
| Performed Procedure Step End Time   | (0040,0251) | TM | Zero length                                                                                                         | Actual end time           |
| Performed Procedure Step Status     | (0040,0252) | CS | IN PROGRESS                                                                                                         | DISCONTINUED or COMPLETED |

|                                                               |             |    |                                                                                                           |                                                                                                                                                                     |
|---------------------------------------------------------------|-------------|----|-----------------------------------------------------------------------------------------------------------|---------------------------------------------------------------------------------------------------------------------------------------------------------------------|
| Performed Procedure Step Discontinuation Reason Code Sequence | (0040,0281) | SQ | Zero length                                                                                               | If Performed Procedure Step Status (0040,0252) is "DISCONTINUED" then a single item will be present containing a user-selected entry drawn from Context Group 9300. |
| Performed Procedure Step ID                                   | (0040,0253) | SH | Automatically created but can be modified by the user.                                                    |                                                                                                                                                                     |
| Performed Procedure Step Description                          | (0040,0254) | LO | From Modality Worklist or user input. The user can modify the description provided via Modality Worklist. |                                                                                                                                                                     |
| Performed Procedure Type Description                          | (0040,0255) | LO | Zero length                                                                                               |                                                                                                                                                                     |
| Performed Protocol Code Sequence                              | (0040,0260) | SQ | Zero length                                                                                               | Zero or more items                                                                                                                                                  |
| Scheduled Step Attributes Sequence                            | (0040,0270) | SQ | If 1st dose applied results in an Instance                                                                |                                                                                                                                                                     |
| > Accession Number                                            | (0008,0050) | SH | From Modality Worklist or user input. The user can modify values provided via Modality Worklist.          |                                                                                                                                                                     |
| > Referenced Study Sequence                                   | (0008,1110) | SQ | From Modality Worklist                                                                                    |                                                                                                                                                                     |
| >> Referenced SOP Class UID                                   | (0008,1150) | UI | From Modality Worklist                                                                                    |                                                                                                                                                                     |
| >> Referenced SOP Instance UID                                | (0008,1155) | UI | From Modality Worklist                                                                                    |                                                                                                                                                                     |
| > Study Instance UID                                          | (0020,000D) | UI | From Modality Worklist                                                                                    |                                                                                                                                                                     |
| > Requested Procedure Description                             | (0032,1060) | LO | From Modality Worklist                                                                                    |                                                                                                                                                                     |
| > Scheduled Procedure Step Description                        | (0040,0007) | LO | From Modality Worklist                                                                                    |                                                                                                                                                                     |
| > Scheduled Protocol Code Sequence                            | (0040,0008) | SQ | From Modality Worklist                                                                                    |                                                                                                                                                                     |
| > Scheduled Procedure Step ID                                 | (0040,0009) | SH | From Modality Worklist                                                                                    |                                                                                                                                                                     |
| > Requested Procedure ID                                      | (0040,1001) | SH | From Modality Worklist                                                                                    |                                                                                                                                                                     |
| Performed Series Sequence                                     | (0040,0340) | SQ | if 1st dose applied results in an instance                                                                | One or more items                                                                                                                                                   |
| > Retrieve AE Title                                           | (0008,0054) | AE | x                                                                                                         | x                                                                                                                                                                   |
| > Series Description                                          | (0008,103E) | LO | x                                                                                                         | x                                                                                                                                                                   |
| > Performing Physician's Name                                 | (0008,1050) | PN | x                                                                                                         | x                                                                                                                                                                   |
| > Operator's Name                                             | (0008,1070) | PN | x                                                                                                         | x                                                                                                                                                                   |

|                                           |             |    |                                         |                                         |
|-------------------------------------------|-------------|----|-----------------------------------------|-----------------------------------------|
| > Referenced Image Sequence               | (0008,1140) | SQ | One or more items                       | One or more items                       |
| >> Referenced SOP Class UID               | (0008,1150) | UI | x                                       | x                                       |
| >> Referenced SOP Instance UID            | (0008,1155) | UI | x                                       | x                                       |
| > Protocol Name                           | (0018,1030) | LO | x                                       | x                                       |
| > Series Instance UID                     | (0020,000E) | UI | x                                       | x                                       |
| > Referenced Standalone SOP Instance Seq. | (0040,0220) | SQ | Zero length (SOP classes not supported) | Zero length (SOP classes not supported) |
| Total Time of Fluoroscopy                 | (0040,0300) | US | Zero length                             | Total time                              |
| Total Number of Exposures                 | (0040,0301) | US | Zero length                             | Number of exposures                     |
| Entrance Dose                             | (0040,0302) | US | Zero length                             | Entrance dose                           |
| Exposed Area                              | (0040,0303) | US | Zero length                             | Exposed area                            |
| Film Consumption Sequence                 | (0040,0321) | SQ | Zero length                             | Zero or more items                      |
| > Medium Type                             | (2000,0030) | CS |                                         | x                                       |
| > Film Size ID                            | (2010,0050) | CS |                                         | x                                       |
| > Number of Films                         | (2100,0170) | IS |                                         | x                                       |

#### B.4.2.2.4 Association Acceptance Policy

The Workflow Application Entity does not accept Associations.

#### B.4.2.3 Hardcopy Application Entity Specification

##### B.4.2.3.1 SOP Classes

EXAMPLE-INTEGRATED-MODALITY provides Standard Conformance to the following SOP Classes:

**Table B.4.2-29  
SOP CLASSES FOR AE HARDCOPY**

| SOP Class Name                        | SOP Class UID          | SCU | SCP |
|---------------------------------------|------------------------|-----|-----|
| Basic Grayscale Print Management Meta | 1.2.840.10008.5.1.1.9  | Yes | No  |
| Presentation LUT                      | 1.2.840.10008.5.1.1.23 | Yes | No  |

##### B.4.2.3.2 Association Policies

###### B.4.2.3.2.1 General

The DICOM standard application context name for DICOM 3.0 is always proposed:

**Table B.4.2-30**

- Standard -

**DICOM APPLICATION CONTEXT FOR AE HARDCOPY**

|                          |                       |
|--------------------------|-----------------------|
| Application Context Name | 1.2.840.10008.3.1.1.1 |
|--------------------------|-----------------------|

**B.4.2.3.2.2 Number of Associations**

EXAMPLE-INTEGRATED-MODALITY initiates one Association at a time for each configured hardcopy device. Multiple hardcopy devices can be configured.

**Table B.4.2-31  
NUMBER OF ASSOCIATIONS INITIATED FOR AE HARDCOPY**

|                                             |                                         |
|---------------------------------------------|-----------------------------------------|
| Maximum number of simultaneous Associations | (number of configured hardcopy devices) |
|---------------------------------------------|-----------------------------------------|

**B.4.2.3.2.3 Asynchronous Nature**

EXAMPLE-INTEGRATED-MODALITY does not support asynchronous communication (multiple outstanding transactions over a single Association).

**Table B.4.2-32  
ASYNCHRONOUS NATURE AS A SCU FOR AE HARDCOPY**

|                                                         |   |
|---------------------------------------------------------|---|
| Maximum number of outstanding asynchronous transactions | 1 |
|---------------------------------------------------------|---|

**B.4.2.3.2.4 Implementation Identifying Information**

The implementation information for this Application Entity is:

**Table B.4.2-33  
DICOM IMPLEMENTATION CLASS AND VERSION FOR AE HARDCOPY**

|                             |                              |
|-----------------------------|------------------------------|
| Implementation Class UID    | 1.xxxxxxx.yyy.etc.ad.inf.usw |
| Implementation Version Name | EXINTMOD_01                  |

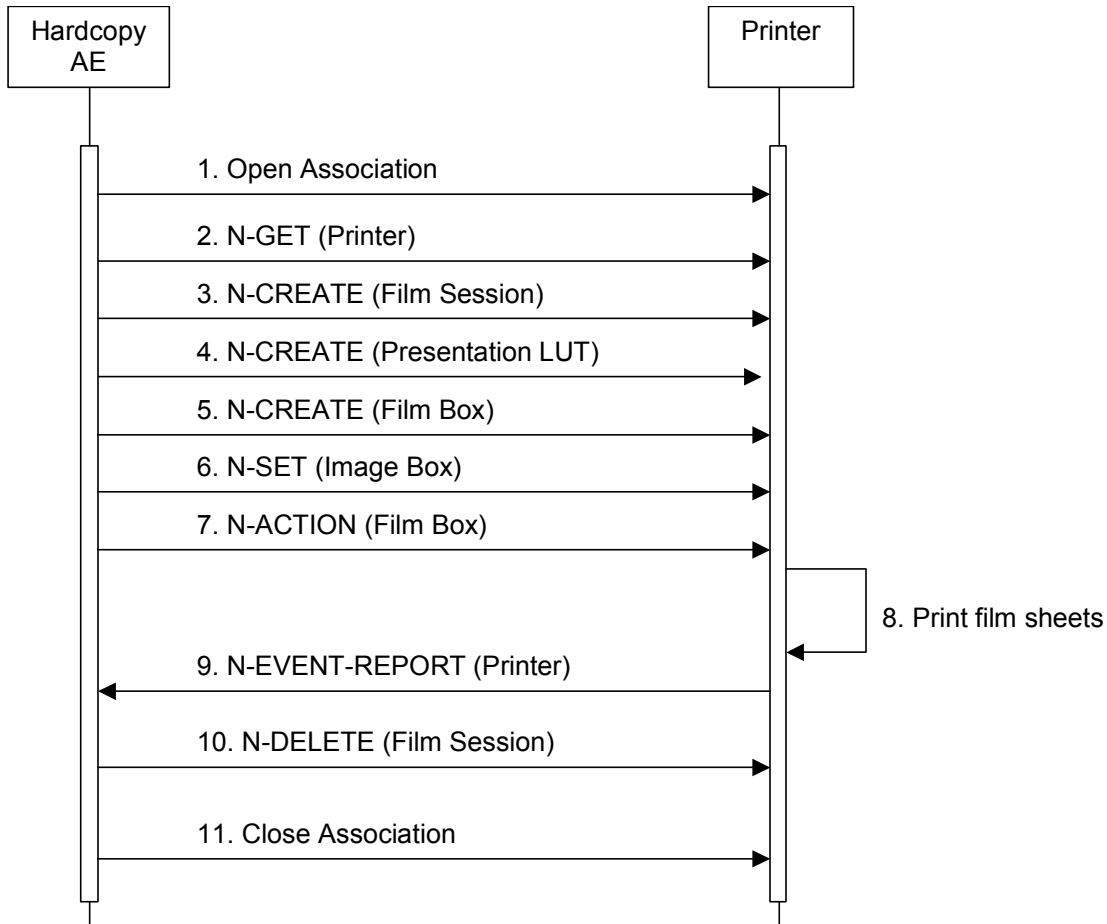
**B.4.2.3.3 Association Initiation Policy**

**B.4.2.3.3.1 Activity – Film Images**

**B.4.2.3.3.1.1 Description and Sequencing of Activities**

A user composes images onto film sheets and requests them to be sent to a specific hardcopy device. The user can select the desired film format and number of copies. Each print-job is forwarded to the job queue and processed individually.

The Hardcopy AE is invoked by the job control interface that is responsible for processing network tasks. The job consists of data describing the images and graphics to be printed as well as the requested layout and other parameters. The film sheet is internally processed, converted to a STANDARD/1,1 page and then the page image is sent. If no association to the printer can be established, the print-job is switched to a failed state and the user informed.



**Figure B.4.2-5**  
**SEQUENCING OF ACTIVITY – FILM IMAGES**

A typical sequence of DIMSE messages sent over an association between Hardcopy AE and a Printer is illustrated in Figure B.4.2-5:

1. Hardcopy AE opens an association with the Printer
2. N-GET on the Printer SOP Class is used to obtain current printer status information. If the Printer reports a status of FAILURE, the print-job is switched to a failed state and the user informed.
3. N-CREATE on the Film Session SOP Class creates a Film Session.
4. N-CREATE on the Presentation LUT SOP Class creates a Presentation LUT (if supported by the printer).
5. N-CREATE on the Film Box SOP Class creates a Film Box linked to the Film Session. A single Image Box will be created as the result of this operation (Hardcopy AE only uses the format STANDARD\1,1)
6. N-SET on the Image Box SOP Class transfers the contents of the film sheet to the printer. If the printer does not support the Presentation LUT SOP Class, the image data will be passed through a printer-specific correction LUT before being sent.
7. N-ACTION on the Film Box SOP Class instructs the printer to print the Film Box
8. The printer prints the requested number of film sheets

9. The Printer asynchronously reports its status via N-EVENT-REPORT notification (Printer SOP Class). The printer can send this message at any time. Hardcopy AE does not require the N-EVENT-REPORT to be sent. Hardcopy AE is capable of receiving an N-EVENT-REPORT notification at any time during an association. If the Printer reports a status of FAILURE, the print-job is switched to a failed state and the user informed.
10. N-DELETE on the Film Session SOP Class deletes the complete Film Session SOP Instance hierarchy.
11. Hardcopy AE closes the association with the Printer

Status of the print-job is reported through the job control interface. Only one job will be active at a time for each separate hardcopy device. If any Response from the remote Application contains a status other than Success or Warning, the Association is aborted and the related Job is switched to a failed state. It can be restarted any time by user interaction or, if configured, by automated retry.

**B.4.2.3.3.1.2 Proposed Presentation Contexts**

EXAMPLE-INTEGRATED-MODALITY is capable of proposing the Presentation Contexts shown in the Table below:

**Table B.4.2-34  
PROPOSED PRESENTATION CONTEXTS FOR ACTIVITY FILM IMAGES**

| Presentation Context Table            |                        |                           |                     |      |           |
|---------------------------------------|------------------------|---------------------------|---------------------|------|-----------|
| Abstract Syntax                       |                        | Transfer Syntax           |                     | Role | Ext. Neg. |
| Name                                  | UID                    | Name List                 | UID List            |      |           |
| Basic Grayscale Print Management Meta | 1.2.840.10008.5.1.1.9  | Implicit VR Little Endian | 1.2.840.10008.1.2   | SCU  | None      |
|                                       |                        | Explicit VR Little Endian | 1.2.840.10008.1.2.1 |      |           |
| Presentation LUT                      | 1.2.840.10008.5.1.1.23 | Implicit VR Little Endian | 1.2.840.10008.1.2   | SCU  | None      |
|                                       |                        | Explicit VR Little Endian | 1.2.840.10008.1.2.1 |      |           |

**B.4.2.3.3.1.3 Common SOP Specific Conformance for all Print SOP Classes**

The general behavior of Hardcopy AE during communication failure is summarized in the Table below. This behavior is common for all SOP Classes supported by Hardcopy AE.

**Table B.4.2-35  
HARDCOPY COMMUNICATION FAILURE BEHAVIOR**

| Exception                                        | Behavior                                                                                                                                                                          |
|--------------------------------------------------|-----------------------------------------------------------------------------------------------------------------------------------------------------------------------------------|
| Timeout                                          | The Association is aborted using A-ABORT and the print-job is marked as failed. The reason is logged and the job failure is reported to the user via the job control application. |
| Association aborted by the SCP or network layers | The print-job is marked as failed. The reason is logged and the job failure is reported to the user via the job control application.                                              |

**B.4.2.3.3.1.4 SOP Specific Conformance for the Printer SOP Class**

Hardcopy AE supports the following DIMSE operations and notifications for the Printer SOP Class:

- N-GET
- N-EVENT-REPORT

Details of the supported attributes and status handling behaviour are described in the following subsections.

**B.4.2.3.3.1.4.1 Printer SOP Class Operations (N-GET)**

Hardcopy AE uses the Printer SOP Class N-GET operation to obtain information about the current printer status. The attributes obtained via N-GET are listed in the Table below:

**Table B.4.2-36  
PRINTER SOP CLASS N-GET REQUEST ATTRIBUTES**

| Attribute Name      | Tag         | VR | Value               | Presence of Value | Source  |
|---------------------|-------------|----|---------------------|-------------------|---------|
| Printer Status      | (2110,0010) | CS | Provided by Printer | ALWAYS            | Printer |
| Printer Status Info | (2110,0020) | CS | Provided by Printer | ALWAYS            | Printer |

The Printer Status information is evaluated as follows:

1. If Printer status (2110,0010) is NORMAL, the print-job continues to be printed.
2. If Printer status (2110,0010) is FAILURE, the print-job is marked as failed. The contents of Printer Status Info (2110,0020) is logged and reported to the user via the job control application.
3. If Printer status (2110,0010) is WARNING, the print-job continues to be printed. The contents of Printer Status Info (2110,0020) is logged and reported to the user via the job control application.

The behavior of Hardcopy AE when encountering status codes in a N-GET response is summarized in the Table below:

**Table B.4.2-37  
PRINTER SOP CLASS N-GET RESPONSE STATUS HANDLING BEHAVIOR**

| Service Status | Further Meaning | Error Code             | Behavior                                                                                                                               |
|----------------|-----------------|------------------------|----------------------------------------------------------------------------------------------------------------------------------------|
| Success        | Success         | 0000                   | The request to get printer status information was success.                                                                             |
| *              | *               | Any other status code. | The Association is aborted using A-ABORT and the print-job is marked as failed. The status meaning is logged and reported to the user. |

**B.4.2.3.3.1.4.2 Printer SOP Class Notifications (N-EVENT-REPORT)**

Hardcopy AE is capable of receiving an N-EVENT-REPORT request at any time during an association.

The behavior of Hardcopy AE when receiving Event Types within the N-EVENT-REPORT is summarized in the Table below:

**Table B.4.2-38  
PRINTER SOP CLASS N-EVENT-REPORT BEHAVIOUR**

| Event Type Name | Event Type ID | Behavior                                                                                                                                                   |
|-----------------|---------------|------------------------------------------------------------------------------------------------------------------------------------------------------------|
| Normal          | 1             | The print-job continues to be printed.                                                                                                                     |
| Warning         | 2             | The print-job continues to be printed. The contents of Printer Status Info (2110,0020) is logged and reported to the user via the job-control application. |
| Failure         | 3             | The print-job is marked as failed. The contents of Printer Status Info (2110,0020) is logged and reported to the user via the job-control application.     |
| *               | *             | An invalid Event Type ID will cause a status code of 0113H to be returned in a N-EVENT-REPORT response.                                                    |

The reasons for returning specific status codes in a N-EVENT-REPORT response are summarized in the Table below:

**Table B.4.2-39  
PRINTER SOP CLASS N-EVENT-REPORT RESPONSE STATUS REASONS**

| Service Status | Further Meaning    | Error Code | Reasons                                                                                                                                             |
|----------------|--------------------|------------|-----------------------------------------------------------------------------------------------------------------------------------------------------|
| Success        | Success            | 0000       | The notification event has been successfully received.                                                                                              |
| Failure        | No Such Event Type | 0113H      | An invalid Event Type ID was supplied in the N-EVENT-REPORT request.                                                                                |
| Failure        | Processing Failure | 0110H      | An internal error occurred during processing of the N-EVENT-REPORT. A short description of the error will be returned in Error Comment (0000,0902). |

**B.4.2.3.3.1.5 SOP Specific Conformance for the Film Session SOP Class**

Hardcopy AE supports the following DIMSE operations for the Film Session SOP Class:

- N-CREATE
- N-DELETE

Details of the supported attributes and status handling behavior are described in the following subsections.

**B.4.2.3.3.1.5.1 Film Session SOP Class Operations (N-CREATE)**

The attributes supplied in an N-CREATE Request are listed in the Table below:

**Table B4.2-40  
FILM SESSION SOP CLASS N-CREATE REQUEST ATTRIBUTES**

| Attribute Name   | Tag         | VR | Value                          | Presence of Value | Source |
|------------------|-------------|----|--------------------------------|-------------------|--------|
| Number of Copies | (2000,0010) | IS | 1 .. 10                        | ALWAYS            | User   |
| Medium Type      | (2000,0030) | CS | BLUE FILM, CLEAR FILM or PAPER | ALWAYS            | User   |
| Film Destination | (2000,0040) | CS | MAGAZINE or PROCESSOR          | ALWAYS            | User   |



The behavior of Hardcopy AE when encountering status codes in a N-CREATE response is summarized in the Table below:

**Table B.4.2-41  
FILM SESSION SOP CLASS N-CREATE RESPONSE STATUS HANDLING BEHAVIOR**

| Service Status | Further Meaning              | Error Code             | Behavior                                                                                                                                                                                                                                |
|----------------|------------------------------|------------------------|-----------------------------------------------------------------------------------------------------------------------------------------------------------------------------------------------------------------------------------------|
| Success        | Success                      | 0000                   | The SCP has completed the operation successfully.                                                                                                                                                                                       |
| Warning        | Attribute Value Out of Range | 0116H                  | The N-CREATE operation is considered successful but the status meaning is logged. Additional information in the Response identifying the attributes out of range will be logged (i.e. Elements in the Modification List/Attribute List) |
| Warning        | Attribute List Error         | 0107H                  | The N-CREATE operation is considered successful but the status meaning is logged. Additional information in the Response identifying the attributes will be logged (i.e. Elements in the Attribute Identifier List)                     |
| *              | *                            | Any other status code. | The Association is aborted using A-ABORT and the print-job is marked as failed. The status meaning is logged and reported to the user.                                                                                                  |

**B.4.2.3.3.1.5.2 Film Session SOP Class Operations (N-DELETE)**

The behavior of Hardcopy AE when encountering status codes in a N-DELETE response is summarized in the Table below:

**Table B.4.2-42  
PRINTER SOP CLASS N-DELETE RESPONSE STATUS HANDLING BEHAVIOR**

| Service Status | Further Meaning | Error Code             | Behavior                                                                                                                               |
|----------------|-----------------|------------------------|----------------------------------------------------------------------------------------------------------------------------------------|
| Success        | Success         | 0000                   | The SCP has completed the operation successfully.                                                                                      |
| *              | *               | Any other status code. | The Association is aborted using A-ABORT and the print-job is marked as failed. The status meaning is logged and reported to the user. |

**B.4.2.3.3.1.6 SOP Specific Conformance for the Presentation LUT SOP Class**

Hardcopy AE supports the following DIMSE operations for the Presentation LUT SOP Class:

— N-CREATE

Details of the supported attributes and status handling behavior are described in the following subsections.

**B.4.2.3.3.1.6.1 Presentation LUT SOP Class Operations (N-CREATE)**

The attributes supplied in an N-CREATE Request are listed in the Table below:

**Table B.4.2-43  
PRESENTATION LUT SOP CLASS N-CREATE REQUEST ATTRIBUTES**

| Attribute Name         | Tag         | VR | Value    | Presence of Value | Source |
|------------------------|-------------|----|----------|-------------------|--------|
| Presentation LUT Shape | (2050,0020) | CS | IDENTITY | ALWAYS            | Auto   |

The behavior of Hardcopy AE when encountering status codes in a N-CREATE response is summarized in the Table below:

**Table B.4.2-44  
PRESENTATION LUT SOP CLASS N-CREATE RESPONSE STATUS HANDLING BEHAVIOR**

| Service Status | Further Meaning                                                           | Error Code             | Behavior                                                                                                                               |
|----------------|---------------------------------------------------------------------------|------------------------|----------------------------------------------------------------------------------------------------------------------------------------|
| Success        | Success                                                                   | 0000                   | The SCP has completed the operation successfully.                                                                                      |
| Warning        | Requested Min Density or Max Density outside of printer's operating range | B605H                  | The N-CREATE operation is considered successful but the status meaning is logged.                                                      |
| *              | *                                                                         | Any other status code. | The Association is aborted using A-ABORT and the print-job is marked as failed. The status meaning is logged and reported to the user. |
| Service Status | Further Meaning                                                           | Error Code             | Behavior                                                                                                                               |
| Success        | Success                                                                   | 0000                   | The SCP has completed the operation successfully.                                                                                      |

**B.4.2.3.3.1.7 SOP Specific Conformance for the Film Box SOP Class**

Hardcopy AE supports the following DIMSE operations for the Presentation LUT SOP Class:

- N-CREATE
- N-ACTION

Details of the supported attributes and status handling behavior are described in the following subsections.

**B.4.2.3.3.1.7.1 Film Box SOP Class Operations (N-CREATE)**

The attributes supplied in an N-CREATE Request are listed in the Table below:

**Table B.4.2-45  
FILM BOX SOP CLASS N-CREATE REQUEST ATTRIBUTES**

| Attribute Name                   | Tag         | VR | Value                                  | Presence of Value | Source |
|----------------------------------|-------------|----|----------------------------------------|-------------------|--------|
| Image Display Format             | (2010,0010) | CS | STANDARD\1,1                           | ALWAYS            | Auto   |
| Referenced Film Session Sequence | (2010,0500) | SQ |                                        | ALWAYS            | Auto   |
| >Referenced SOP Class UID        | (0008,1150) | UI | 1.2.840.10008.5.1.1.1                  | ALWAYS            | Auto   |
| >Referenced SOP Instance UID     | (0008,1155) | UI | From created Film Session SOP Instance | ALWAYS            | Auto   |

|                                      |             |    |                                                                 |        |      |
|--------------------------------------|-------------|----|-----------------------------------------------------------------|--------|------|
| Film Orientation                     | (2010,0040) | CS | PORTRAIT or LANDSCAPE                                           | ALWAYS | User |
| Film Size ID                         | (2010,0050) | CS | 14INX17IN, 14INX14IN, 11INX14IN, 11INX11IN, 85INX11IN, 8INX10IN | ALWAYS | User |
| Magnification Type                   | (2010,0060) | CS | REPLICATE, BILINEAR, CUBIC or NONE                              | ALWAYS | User |
| Border Density                       | (2010,0100) | CS | BLACK or WHITE                                                  | ALWAYS | User |
| Max Density                          | (2010,0130) | US | 0 .. 310                                                        | ALWAYS | Auto |
| Min Density                          | (2010,0120) | US | 0 .. 50                                                         | ALWAYS | Auto |
| Illumination                         | (2010,015E) | US | 0 .. 5000                                                       | ALWAYS | User |
| Reflective Ambient Light             | (2010,0160) | US | 0 .. 100                                                        | ALWAYS | User |
| Referenced Presentation LUT Sequence | (2050,0500) | SQ | Only sent if Presentation LUT SOP Class has been negotiated.    | ANAP   | Auto |
| >Referenced SOP Class UID            | (0008,1150) | UI | 1.2.840.10008.5.1.1.23                                          | ALWAYS | Auto |
| >Referenced SOP Instance UID         | (0008,1155) | UI | From created Presentation LUT SOP Instance                      | ALWAYS | Auto |

The behavior of Hardcopy AE when encountering status codes in a N-CREATE response is summarized in the Table below:

**Table B.4.46**  
**FILM BOX SOP CLASS N-CREATE RESPONSE STATUS HANDLING BEHAVIOR**

| Service Status | Further Meaning                                                           | Error Code             | Behavior                                                                                                                               |
|----------------|---------------------------------------------------------------------------|------------------------|----------------------------------------------------------------------------------------------------------------------------------------|
| Success        | Success                                                                   | 0000                   | The SCP has completed the operation successfully.                                                                                      |
| Warning        | Requested Min Density or Max Density outside of printer's operating range | B605H                  | The N-CREATE operation is considered successful but the status meaning is logged.                                                      |
| *              | *                                                                         | Any other status code. | The Association is aborted using A-ABORT and the print-job is marked as failed. The status meaning is logged and reported to the user. |

#### **B.4.2.3.3.1.7.2 Film Box SOP Class Operations (N-ACTION)**

An N-ACTION Request is issued to instruct the Print SCP to print the contents of the Film Box. The Action Reply argument in an N-ACTION response is not evaluated.

The behavior of Hardcopy AE when encountering status codes in a N-ACTION response is summarized in the Table below:

**Table B.4.2-47**  
**FILM BOX SOP CLASS N-ACTION RESPONSE STATUS HANDLING BEHAVIOR**

| Service Status | Further Meaning                                                                                                                     | Error Code             | Behavior                                                                                                                               |
|----------------|-------------------------------------------------------------------------------------------------------------------------------------|------------------------|----------------------------------------------------------------------------------------------------------------------------------------|
| Success        | Success                                                                                                                             | 0000                   | The SCP has completed the operation successfully. The film has been accepted for printing.                                             |
| Warning        | Film Box SOP Instance hierarchy does not contain Image Box SOP Instances (empty page)                                               | B603H                  | The Association is aborted using A-ABORT and the print-job is marked as failed. The status meaning is logged and reported to the user. |
| Warning        | Image size is larger than Image Box size. The image has been demagnified.                                                           | B604H                  | The N-ACTION operation is considered successful but the status meaning is logged.                                                      |
| Warning        | Image size is larger than Image Box size. The image has been cropped to fit.                                                        | B609H                  | The N-ACTION operation is considered successful but the status meaning is logged.                                                      |
| Warning        | Image size or Combined Print Image Size is larger than Image Box size. The image or combined Print Image has been decimated to fit. | B60AH                  | The N-ACTION operation is considered successful but the status meaning is logged.                                                      |
| Failure        | Unable to create Print Job SOP Instance; print queue is full.                                                                       | C602                   | The Association is aborted using A-ABORT and the print-job is marked as failed. The status meaning is logged and reported to the user. |
| Failure        | Image size is larger than Image Box size.                                                                                           | C603                   | The Association is aborted using A-ABORT and the print-job is marked as failed. The status meaning is logged and reported to the user. |
| Failure        | Combined Print Image Size is larger than Image Box size.                                                                            | C613                   | The Association is aborted using A-ABORT and the print-job is marked as failed. The status meaning is logged and reported to the user. |
| *              | *                                                                                                                                   | Any other status code. | The Association is aborted using A-ABORT and the print-job is marked as failed. The status meaning is logged and reported to the user. |

#### B.4.2.3.3.1.8 SOP Specific Conformance for the Image Box SOP Class

Hardcopy AE supports the following DIMSE operations for the Image Box SOP Class:

— N-SET

Details of the supported attributes and status handling behavior are described in the following subsections.

#### B.4.2.3.3.1.8.1 Image Box SOP Class Operations (N-SET)

The attributes supplied in an N-SET Request are listed in the Table below:

**Table B.4.2-48  
IMAGE BOX SOP CLASS N-SET REQUEST ATTRIBUTES**

| Attribute Name                 | Tag         | VR | Value                         | Presence of Value | Source |
|--------------------------------|-------------|----|-------------------------------|-------------------|--------|
| Image Position                 | (2020,0010) | US | 1                             | ALWAYS            | Auto   |
| Basic Grayscale Image Sequence | (2020,0110) | SQ |                               | ALWAYS            | Auto   |
| >Samples Per Pixel             | (0028,0002) | US | 1                             | ALWAYS            | Auto   |
| >Photometric Interpretation    | (0028,0004) | CS | MONOCHROME2                   | ALWAYS            | Auto   |
| >Rows                          | (0028,0010) | US | Depends on film size          | ALWAYS            | Auto   |
| >Columns                       | (0028,0011) | US | Depends on film size          | ALWAYS            | Auto   |
| >Pixel Aspect Ratio            | (0028,0034) | IS | 1:1                           | ALWAYS            | Auto   |
| >Bits Allocated                | (0028,0100) | US | 8                             | ALWAYS            | Auto   |
| >Bits Stored                   | (0028,0101) | US | 8                             | ALWAYS            | Auto   |
| >High Bit                      | (0028,0102) | US | 7                             | ALWAYS            | Auto   |
| >Pixel Representation          | (0028,0103) | US | 0                             | ALWAYS            | Auto   |
| >Pixel Data                    | (7FE0,0010) | OB | Pixels of rendered film sheet | ALWAYS            | Auto   |

The behavior of Hardcopy AE when encountering status codes in a N-SET response is summarized in the Table below:

**Table B.4.2-49**  
**IMAGE BOX SOP CLASS N-SET RESPONSE STATUS HANDLING BEHAVIOR**

| Service Status | Further Meaning                                                                                                                     | Error Code | Behavior                                                                                                     |
|----------------|-------------------------------------------------------------------------------------------------------------------------------------|------------|--------------------------------------------------------------------------------------------------------------|
| Success        | Success                                                                                                                             | 0000       | The SCP has completed the operation successfully. Image successfully stored in Image Box.                    |
| Warning        | Image size is larger than Image Box size. The image has been demagnified.                                                           | B604H      | The N-SET operation is considered successful but the status meaning is logged.                               |
| Warning        | Requested Min Density or Max Density outside of printer's operating range.                                                          | B605H      | The N-SET operation is considered successful but the status meaning is logged.                               |
| Warning        | Image size is larger than Image Box size. The image has been cropped to fit.                                                        | B609H      | The N-SET operation is considered successful but the status meaning is logged.                               |
| Warning        | Image size or Combined Print Image Size is larger than Image Box size. The image or combined Print Image has been decimated to fit. | B60AH      | The N-SET operation is considered successful but the status meaning is logged.                               |
| Failure        | Image size is larger than Image Box size.                                                                                           | C603       | The Association is aborted using A-ABORT and the print-job is marked as failed. The status meaning is logged |

|         |                                                          |                        |                                                                                                                                        |
|---------|----------------------------------------------------------|------------------------|----------------------------------------------------------------------------------------------------------------------------------------|
|         |                                                          |                        | and reported to the user.                                                                                                              |
| Failure | Insufficient memory in printer to store the image.       | C605                   | The Association is aborted using A-ABORT and the print-job is marked as failed. The status meaning is logged and reported to the user. |
| Failure | Combined Print Image Size is larger than Image Box size. | C613                   | The Association is aborted using A-ABORT and the print-job is marked as failed. The status meaning is logged and reported to the user. |
| *       | *                                                        | Any other status code. | The Association is aborted using A-ABORT and the print-job is marked as failed. The status meaning is logged and reported to the user. |

#### B.4.2.3.4 Association Acceptance Policy

The Hardcopy Application Entity does not accept Associations.

### B.4.3 NETWORK INTERFACES

#### B.4.3.1 Physical Network Interface

EXAMPLE-INTEGRATED-MODALITY supports a single network interface. One of the following physical network interfaces will be available depending on installed hardware options:

**Table B.4.3-1  
SUPPORTED PHYSICAL NETWORK INTERFACES**

|                   |
|-------------------|
| Ethernet 100baseT |
| Ethernet 10baseT  |

#### B.4.3.2 Additional Protocols

EXAMPLE-INTEGRATED-MODALITY conforms to the System Management Profiles listed in the Table below. All requested transactions for the listed profiles and actors are supported. Support for optional transactions are listed in the Table below:

**Table B.4.3-2  
SUPPORTED SYSTEM MANAGEMENT PROFILES**

| Profile Name                               | Actor       | Protocols Used | Optional Transactions     | Security Support |
|--------------------------------------------|-------------|----------------|---------------------------|------------------|
| Network Address Management                 | DHCP Client | DHCP           | N/A                       |                  |
|                                            | DNS Client  | DNS            | N/A                       |                  |
| Time Synchronization                       | NTP Client  | NTP            | Find NTP Server           |                  |
|                                            | DHCP Client | DHCP           | N/A                       |                  |
| DICOM Application Configuration Management | LDAP Client | LDAP           | Client Update LDAP Server | See Section      |

### B.4.3.2.1 DHCP

DHCP can be used to obtain TCP/IP network configuration information. The network parameters obtainable via DHCP are shown in the Table below. The Default Value column of the table shows the default used if the DHCP server does not provide a value. Values for network parameters set in the Service/Installation tool take precedence over values obtained from the DHCP server. Support for DHCP can be configured via the Service/Installation Tool. The Service/Installation tool can be used to configure the machine name. If DHCP is not in use, TCP/IP network configuration information can be manually configured via the Service/Installation Tool.

**Table B.4.3-3  
SUPPORTED DHCP PARAMETERS**

| DHCP Parameter      | Default Value                                |
|---------------------|----------------------------------------------|
| IP Address          | None                                         |
| Hostname            | Requested machine name                       |
| List of NTP servers | Empty list                                   |
| List of DNS servers | Empty list                                   |
| Routers             | Empty list                                   |
| Static routes       | None                                         |
| Domain name         | None                                         |
| Subnet mask         | Derived from IP Address (see service manual) |
| Broadcast address   | Derived from IP Address (see service manual) |
| Default router      | None                                         |
| Time offset         | Site configurable (from Timezone)            |
| MTU                 | Network Hardware Dependent                   |
| Auto-IP permission  | No permission                                |

If the DHCP server refuses to renew a lease on the assigned IP address all active DICOM Associations will be aborted.

### B.4.3.2.2 DNS

DNS can be used for address resolution. If DHCP is not in use or the DHCP server does not return any DNS server addresses, the identity of a DNS server can be configured via the Service/Installation Tool. If a DNS server is not in use, local mapping between hostname and IP address can be manually configured via the Service/Installation Tool.

### B.4.3.2.3 NTP

The NTP client implements the optional Find NTP Server Transaction. The NTP client will issue an NTP broadcast to identify any local NTP servers. If no local servers can be found via NTP broadcast, the NTP Servers identified by DHCP will be used as time references. Additionally, one or more NTP Servers can be configured via the Service/Installation Tool. If no NTP Servers are identified then the local clock will be used as a time reference and a warning written to the system log files.

### B.4.3.2.4 LDAP

LDAP can be used to obtain information about network Application Entities. The identity of an LDAP server can be obtained using the Find LDAP Server Transaction of the DICOM Application Configuration Management Profile (i.e. a DNS SRV RR query for the LDAP service) and the first LDAP server returned will be used. The Service/Installation Tool can also be used to manually configure the identity of an LDAP server (a manually entered value takes precedence).

LDAP Basic Authentication can be configured via the Service/Installation Tool by specifying a bind DN and password. If LDAP Basic Authentication is not configured the LDAP client will bind anonymously.

The supported LDAP Security Profiles are:

- Basic
- Basic-Manual
- Anonymous
- Anonymous-Manual

The use of LDAP to publish and obtain device configuration information is described in Section 4.4.

### **B.4.3.3 IPv4 and IPv6 Support**

This product only supports IPv4 connections.

## **B.4.4 CONFIGURATION**

### **B.4.4.1 AE Title/Presentation Address Mapping**

#### **B.4.4.1.1 Local AE Titles**

All local applications use the AE Titles and TCP/IP Ports configured via the Service/Installation Tool. The Field Service Engineer can configure the TCP Port via the Service/Installation Tool. No Default AE Titles are provided. The AE Titles must be configured during installation. The local AE Title used by each individual application can be configured independently of the AE Title used by other local applications. If so configured, all local AEs are capable of using the same AE Title.

**Table B.4.4-1  
AE TITLE CONFIGURATION TABLE**

| <b>Application Entity</b> | <b>Default AE Title</b> | <b>Default TCP/IP Port</b> |
|---------------------------|-------------------------|----------------------------|
| Storage                   | No Default              | 104                        |
| Workflow                  | No Default              | Not Applicable             |
| Hardcopy                  | No Default              | Not Applicable             |

#### **B.4.4.1.1.1 Obtaining Local Configuration from LDAP Server**

The Service/Installation Tool can be used to specify that an LDAP Server be the master of local configuration information. The Query LDAP Server transaction of the Network Configuration Profile is used to obtain configuration information. The LDAP

Server will be queried for updated information at boot time but the query can also be manually invoked from the Service/Installation Tool. A search is performed for an LDAP entity within the DICOM configuration sub-tree having an identical device name (as entered in the Service/Installation Tool). The local configuration will be updated to match the central configuration (i.e. AE Titles, TCP Port Numbers, Peer AEs, Private Data, etc). The central configuration information will be checked for consistency before the local configuration is updated.

The configuration parameters that can be updated by the central LDAP server and can affect the local configuration for the device are listed in the Table below:

**Table B.4.4-2  
DEVICE CONFIGURATION PARAMETERS OBTAINED FROM LDAP SERVER**

- Standard -



| LDAP object class | LDAP attribute   | Local Meaning                                                                            |
|-------------------|------------------|------------------------------------------------------------------------------------------|
| dicomDevice       | dicomDescription | Displayed in the Service/Installation Tool                                               |
| dicomDevice       | dicomVendorData  | Private device configuration parameters (e.g. examination protocol codes and parameters) |
| dicomDevice       | dicomDeviceType  | Displayed in the Service/Installation Tool                                               |

The Application Entities described by the LDAP server are matched to the supported local application entities (Storage, Workflow or Hardcopy) by inspecting the private information within the dicomVendorData attribute for each dicomNetworkAE.

The configuration parameters that can be updated by the central LDAP server and affect the local configuration for each supported local AE are listed in the Table below:

**Table B.4.4-3  
AE CONFIGURATION PARAMETERS OBTAINED FROM LDAP SERVER**

| LDAP object class | LDAP attribute                  | Local Meaning                                                                                                      |
|-------------------|---------------------------------|--------------------------------------------------------------------------------------------------------------------|
| dicomNetworkAE    | dicomAETitle                    | Local AE Title(s)                                                                                                  |
| dicomNetworkAE    | dicomDescription                | Displayed in the Service/Installation Tool                                                                         |
| dicomNetworkAE    | dicomNetworkConnectionReference | Associated network connection parameters                                                                           |
| dicomNetworkAE    | dicomPeerAETitle                | Default collection of Peer AE                                                                                      |
| dicomNetworkAE    | dicomVendorData                 | Private AE configuration parameters (e.g. timeouts, max PDU lengths, maximum number of simultaneous associations). |
| dicomNetworkAE    | dicomApplicationCluster         | Displayed in the Service/Installation Tool                                                                         |

The configuration parameters that can be updated by the central LDAP server and affect the local configuration for the network connection are listed in the Table below:

**Table B.4.4-4  
NETWORK CONNECTION CONFIGURATION PARAMETERS OBTAINED FROM LDAP SERVER**

| LDAP object class      | LDAP attribute | Local Meaning |
|------------------------|----------------|---------------|
| dicomNetworkConnection | dicomHostname  | Hostname      |
| dicomNetworkConnection | dicomPort      | TCP Port      |

#### **B.4.4.1.1.2 Publishing Local Configuration to LDAP Server**

The Service/Installation Tool can be used to publish local configuration information to the LDAP Server.

The LDAP client will bind to the server using LDAP Basic Authentication (or anonymously if LDAP Basic Authentication is not configured). The LDAP Client expects that the necessary DICOM Root objects exist in the LDAP DIT and performed searches to identify the following information:

- a)The DN of the dicomConfigurationRoot identifying the root if all DICOM Configuration information.
- b)The DN of the dicomDevicesRoot under which new devices can be inserted
- c)The DN of the dicomUniqueAETitlesRegistryRoot under which unique AE Titles can be registered

- d) The DN of any existing dicomDevice object that represents the device hosting the LDAP client (dicomDeviceName identical to locally configured device name).

Modifications can be made to existing LDAP entries for the device or new entries will be created if necessary. It is possible to manually assign AE Titles for each local Application Entity or to automatically generate random AE Titles. In both cases, the LDAP server is queried to determine that the AE Titles are currently unused.

Two different methods (Manual and Automatic) are supported to update the LDAP server and an appropriate method must be selected depending on the security policies enforced by the LDAP server.

#### Manual Update

- An LDIF file (RFC 2489) will be created containing all new or updated LDAP objects and attributes. The objects will be appropriately located in the server's LDAP tree. The LDIF file will be written to the local file system or to exchangeable media (e.g. floppy). The file can be transferred to the LDAP server and imported using server specific tools.

#### Automatic Update

- The LDAP client will attempt to register unique AE Titles. If the manually chosen AE Titles are manually already in use the update will be aborted and new AE Titles must be chosen. If AE Titles were randomly selected the LDAP client will use the random AE Title allocation technique described by the "Update LDAP Server" transaction of the DICOM Application Configuration Management Profile.
- The LDAP client will create new LDAP objects or update existing objects as necessary at appropriate locations in the server's LDAP tree.
- If the server refuses any object creation or update operation the Automatic Update will be aborted. In case of failure, the LDAP server may contain partial configuration information that must be corrected by the LDAP server administrator.

The same set of LDAP objects and attributes will be entered into the LDAP DIT for both the Manual and Automatic Update methods. Values for all configurable attributes can be entered using Service/Installation Tool. Table 59 lists the attributes and default values created for the installed device.

**Table B.4.4-5  
DEVICE CONFIGURATION PARAMETERS UPDATED ON LDAP SERVER**

| LDAP object class | LDAP attribute             | Configurable (Yes/No) | Default Value                                 |
|-------------------|----------------------------|-----------------------|-----------------------------------------------|
| dicomDevice       | dicomDeviceName            | Yes                   |                                               |
|                   | dicomDescription           | Yes                   | Radio-Fluoroscopic Image Acquisition Modality |
|                   | dicomManufacturer          | No                    | EXAMPLE-IMAGING-PRODUCTS                      |
|                   | dicomManufacturerModelName | No                    | Example-Integrated-Modality                   |
|                   | dicomVersion               | No                    | 1                                             |
|                   | dicomPrimaryDeviceType     | No                    | RF                                            |
|                   | dicomVendorData            | Yes                   |                                               |

Table 60 lists the attributes and default values used to describe the network configuration:

**Table B.4.4-6  
NETWORK CONNECTION CONFIGURATION PARAMETERS UPDATED ON LDAP SERVER**

| LDAP object class      | LDAP attribute | Configurable (Yes/No) | Default Value |
|------------------------|----------------|-----------------------|---------------|
| dicomNetworkConnection | dicomHostname  | Yes                   |               |
|                        | dicomPort      | Yes                   | 104           |

The Table below lists the attributes and default values used to describe the Storage AE:

**Table B.4.4-7  
STORAGE AE CONFIGURATION PARAMETERS UPDATED ON LDAP SERVER**

| LDAP object class       | LDAP attribute            | Configurable (Yes/No) | Default Value                                                                                                           |
|-------------------------|---------------------------|-----------------------|-------------------------------------------------------------------------------------------------------------------------|
| dicomNetworkAE          | dicomAETitle              | Yes                   |                                                                                                                         |
|                         | dicomDescription          | Yes                   | Storage Application                                                                                                     |
|                         | dicomPeerAETitle          | Yes                   |                                                                                                                         |
|                         | dicomVendorData           | Yes                   |                                                                                                                         |
|                         | dicomApplicationCluster   | Yes                   |                                                                                                                         |
|                         | dicomAssociationInitiator | No                    | TRUE                                                                                                                    |
|                         | dicomAssociationAcceptor  | No                    | TRUE                                                                                                                    |
| dicomTransferCapability | dicomSOPClass             | No                    | X-Ray RadioFluoroscopic Image Storage<br>Grayscale Softcopy Presentation State Storage<br>Storage Commitment Push Model |
|                         | dicomTransferRole         | No                    | SCU                                                                                                                     |
|                         | dicomTransferSyntax       | Yes                   | Explicit VR Little Endian<br>Implicit VR Little Endian                                                                  |

The Table below lists the attributes and default values used to describe the Workflow AE:

**Table B.4.4-8  
WORKFLOW AE CONFIGURATION PARAMETERS UPDATED ON LDAP SERVER**

| LDAP object class | LDAP attribute   | Configurable (Yes/No) | Default Value        |
|-------------------|------------------|-----------------------|----------------------|
| dicomNetworkAE    | dicomAETitle     | Yes                   |                      |
|                   | dicomDescription | Yes                   | Workflow Application |
|                   | dicomPeerAETitle | Yes                   |                      |
|                   | dicomVendorData  | Yes                   |                      |

|                         |                           |     |                                                                                       |
|-------------------------|---------------------------|-----|---------------------------------------------------------------------------------------|
|                         | dicomApplicationCluster   | Yes |                                                                                       |
|                         | dicomAssociationInitiator | No  | TRUE                                                                                  |
|                         | dicomAssociationAcceptor  | No  | FALSE                                                                                 |
| dicomTransferCapability | dicomSOPClass             | No  | Modality Worklist<br>Information Model – FIND<br>Modality Performed<br>Procedure Step |
|                         | dicomTransferRole         | No  | SCU                                                                                   |
|                         | dicomTransferSyntax       | Yes | Explicit VR Little Endian<br>Implicit VR Little Endian                                |

The Table below lists the attributes and default values used to describe the Hardcopy AE:

**Table B.4.4-9  
HARDCOPY AE CONFIGURATION PARAMETERS UPDATED ON LDAP SERVER**

| LDAP object class       | LDAP attribute                   | Configurable (Yes/No) | Default Value                                                |
|-------------------------|----------------------------------|-----------------------|--------------------------------------------------------------|
| dicomNetworkAE          | dicomAETitle                     | Yes                   |                                                              |
|                         | dicomDescription                 | Yes                   | Hardcopy Application                                         |
|                         | dicomNetworkConnection Reference | n/a                   |                                                              |
|                         | dicomPeerAETitle                 | Yes                   |                                                              |
|                         | dicomVendorData                  | Yes                   |                                                              |
|                         | dicomApplicationCluster          | Yes                   |                                                              |
|                         | dicomAssociationInitiator        | No                    | TRUE                                                         |
|                         | dicomAssociationAcceptor         | No                    | FALSE                                                        |
| dicomTransferCapability | dicomSOPClass                    | No                    | Basic Grayscale Print<br>Management Meta<br>Presentation LUT |
|                         | dicomTransferRole                | No                    | SCU                                                          |
|                         | dicomTransferSyntax              | Yes                   | Explicit VR Little Endian<br>Implicit VR Little Endian       |

#### **B.4.4.1.2 Remote AE Title/Presentation Address Mapping**

The AE Title, host names and port numbers of remote applications are configured using the EXAMPLE-INTEGRATED-MODALITY Service/Installation Tool.

##### **B.4.4.1.2.1 Storage**

The EXAMPLE-INTEGRATED-MODALITY Service/Installation Tool must be used to set the AE Titles, port-numbers, host-names and capabilities for the remote Storage SCPs. Associations will only be accepted from known AE Titles and associations from unknown AE Titles will be rejected (an AE Title is known if it can be selected within the Service/Installation Tool). Multiple remote Storage SCPs can be defined. Any Storage SCP can be configured to be an “Archive” device causing storage commitment to be requested for images or presentation states transmitted to the device.

If an LDAP server is available, the Service/Installation Tool will search for suitable remote Storage SCPs and present these for selection. If the LDAP object for the Storage AE contains one or more dicomPeerAETitle attributes then only these Peer AEs will be available for selection. Otherwise, remote

AEs will only be available for selection if they support compatible SOP Classes as an SCP. If a remote AE is attached to a device containing a dicomDeviceType attribute with value "ARCHIVE" it will be automatically configured as an "Archive" device provided the AE also supports Storage Commitment as an SCP.

These LDAP-assisted selection policies can be overridden and a search performed for a specific device or AE Title.

#### **B.4.4.1.2.2 Workflow**

The EXAMPLE-INTEGRATED-MODALITY Service/Installation Tool must be used to set the AE Title, port-number, host-name and capabilities of the remote Modality Worklist SCP. Only a single remote Modality Worklist SCP can be defined.

If an LDAP server is available, the Service/Installation Tool will search for suitable remote Modality Worklist SCPs and present these for selection. Remote AEs will only be available for selection if they support the Modality Worklist SOP Class as an SCP. If a remote AE is attached to a device containing a dicomDeviceType attribute with value "DSS" (Department System Scheduler) it will be presented as the preferred selection.

The EXAMPLE-INTEGRATED-MODALITY Service/Installation Tool must be used to set the AE Title, port-number, host-name and capabilities of the remote MPPS SCP. Only a single remote MPPS SCP can be defined.

If an LDAP server is available, the Service/Installation Tool will search for suitable remote MPPS SCPs and present these for selection. Remote AEs will only be available for selection if they support the MPPS SOP Class as an SCP. If a remote AE is attached to a device containing a dicomDeviceType attribute with value "DSS" (Department System Scheduler) it will be presented as the preferred selection.

#### **B.4.4.1.2.3 Hardcopy**

The EXAMPLE-INTEGRATED-MODALITY Service/Installation Tool must be used to set the AETsAE Titles, port-numbers, host-names, IPaddresses and capabilities for the remote Print SCPs.

Multiple remote Print SCPs can be defined.

If an LDAP server is available, the Service/Installation Tool will search for suitable remote Print SCPs and present these for selection. Remote AEs will only be available for selection if they support the Basic Grayscale Print Management Meta SOP Class as an SCP. If a remote AE is attached to a device containing a dicomDeviceType attribute with value "PRINT" (Hard Copy Print Server) it will be presented as the preferred selection.

#### **B.4.4.2 Parameters**

A large number of parameters related to acquisition and general operation can be configured using the Service/Installation Tool. The Table below only shows those configuration parameters relevant to DICOM communication. See the EXAMPLEINTEGRATED-MODALITY Service Manual for details on general configuration capabilities.

**Table B.4.4-10  
CONFIGURATION PARAMETERS TABLE**

| <b>Parameter</b>                                                                                                                                      | <b>Configurable<br/>(Yes/No)</b> | <b>Default Value</b>   |
|-------------------------------------------------------------------------------------------------------------------------------------------------------|----------------------------------|------------------------|
| <b>General Parameters</b>                                                                                                                             |                                  |                        |
| Max PDU Receive Size                                                                                                                                  | Yes                              | 65536 Bytes<br>(64 kB) |
| Max PDU Send Size<br>(larger PDUs will never be sent, even if the receiver supports a larger Max PDU Receive Size. If the receiver supports a smaller | No                               | 65536 Bytes<br>(64 kB) |

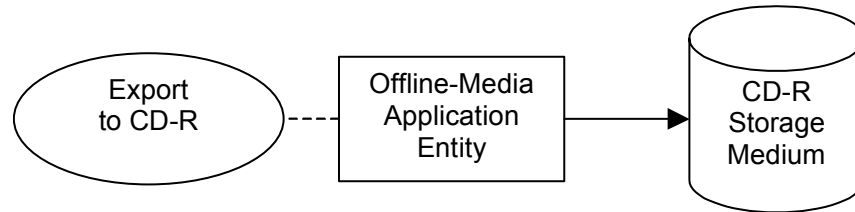
| Parameter                                                                                                                                                                                                                                                                      | Configurable (Yes/No) | Default Value                                          |
|--------------------------------------------------------------------------------------------------------------------------------------------------------------------------------------------------------------------------------------------------------------------------------|-----------------------|--------------------------------------------------------|
| Max PDU Receive Size then the Max PDU Send Size will be reduced accordingly for the duration of the Association. Max PDU Receive Size information is exchanged during DICOM Association Negotiation in the Maximum Length Sub-Item of the A-ASSOCIATION-RQ and A-ASSOCIATE-AC) |                       |                                                        |
| Time-out waiting for a acceptance or rejection response to an Association Request (Application Level Timeout)                                                                                                                                                                  | Yes                   | 15 s                                                   |
| Time-out waiting for a response to an Association release request (Application Level Timeout)                                                                                                                                                                                  | Yes                   | 30 s                                                   |
| Time-out waiting for completion of a TCP/IP connect request (Low-level timeout)                                                                                                                                                                                                | Yes                   | 15 s                                                   |
| Time-out awaiting a Response to a DIMSE Request (Low-Level Timeout)                                                                                                                                                                                                            | Yes                   | 360 s                                                  |
| Time-out for waiting for data between TCP/IP-packets (Low Level Timeout)                                                                                                                                                                                                       | Yes                   | 30 s                                                   |
| <b>Storage Parameters</b>                                                                                                                                                                                                                                                      |                       |                                                        |
| Storage SCU time-out waiting for a response to a C-STORE-RQ                                                                                                                                                                                                                    | Yes                   | 120 s                                                  |
| Number of times a failed send job may be retried                                                                                                                                                                                                                               | Yes                   | 0 (Failed send jobs are not retried)                   |
| Delay between retrying failed send jobs                                                                                                                                                                                                                                        | Yes                   | 60 s                                                   |
| Maximum number of simultaneously initiated Associations by the Storage AE                                                                                                                                                                                                      | Yes                   | 1                                                      |
| Supported Transfer Syntaxes (separately configurable for each remote AE)                                                                                                                                                                                                       | Yes                   | Implicit VR Little Endian<br>Explicit VR Little Endian |
| <b>Storage Commitment Parameters</b>                                                                                                                                                                                                                                           |                       |                                                        |
| Timeout waiting for a Storage Commitment Notification (maximum duration of applicability for a Storage Commitment Transaction UID).                                                                                                                                            | Yes                   | 24 hours                                               |
| Maximum number of simultaneously accepted Associations by the Storage AE                                                                                                                                                                                                       | Yes                   | 5                                                      |
| Delay association release after sending a Storage Commitment Request (wait for a Storage Commitment Notification over the same association).                                                                                                                                   | Yes                   | 120 s                                                  |
| <b>Modality Worklist Parameters</b>                                                                                                                                                                                                                                            |                       |                                                        |
| Modality Worklist SCU time-out waiting for the final response to a C-FIND-RQ                                                                                                                                                                                                   | Yes                   | 600 s                                                  |
| Maximum number of Worklist Items                                                                                                                                                                                                                                               | Yes                   | 100                                                    |
| Supported Transfer Syntaxes for Modality Worklist                                                                                                                                                                                                                              | Yes                   | Implicit VR Little Endian<br>Explicit VR Little Endian |
| Delay between automatic Worklist Updates                                                                                                                                                                                                                                       | Yes                   | 10 mins                                                |
| Query Worklist for specific Scheduled Station AE Title                                                                                                                                                                                                                         | Yes                   | EXINTMOD_WFL                                           |

| Parameter                                                                     | Configurable<br>(Yes/No) | Default Value                                          |
|-------------------------------------------------------------------------------|--------------------------|--------------------------------------------------------|
| Query Worklist for specific Modality Value                                    | Yes                      | RF                                                     |
| <b>MPPS Parameters</b>                                                        |                          |                                                        |
| MPPS SCU time-out waiting for a response to a N-CREATE-RQ                     | Yes                      | 60 s                                                   |
| MPPS SCU time-out waiting for a response to a N-SET-RQ                        | Yes                      | 30 s                                                   |
| Supported Transfer Syntaxes for MPPS                                          | Yes                      | Implicit VR Little Endian<br>Explicit VR Little Endian |
| <b>Print Parameters</b>                                                       |                          |                                                        |
| Print SCU time-out waiting for a response to a N-CREATE-RQ                    | Yes                      | 60 s                                                   |
| Print SCU time-out waiting for a response to a N-SET-RQ                       | Yes                      | 30 s                                                   |
| Print SCU time-out waiting for a response to a N-ACTION-RQ                    | Yes                      | 360s                                                   |
| Supported Transfer Syntaxes (separately configurable for each remote printer) | Yes                      | Implicit VR Little Endian<br>Explicit VR Little Endian |
| Number of times a failed print-job may be retried                             | Yes                      | 0 (Failed send jobs are not retried)                   |
| Delay between retrying failed print-jobs                                      | Yes                      | 60 s                                                   |
| Printer correction LUT (separately configurable for each remote printer)      | Yes                      | Identity LUT                                           |

## B.5 MEDIA INTERCHANGE

### B.5.1 IMPLEMENTATION MODEL

#### B.5.1.1 Application Data Flow



**Figure B.5.1-1  
APPLICATION DATA FLOW DIAGRAM FOR MEDIA STORAGE**

- The Offline-Media Application Entity exports images and Presentation States to a CD-R Storage medium. It is associated with the local real-world activity “Export to CD-R”. “Export to CD-R” is performed upon user request for selected patients, studies, series or instances (images or presentation states).

#### B.5.1.2 Functional Definition of AEs

##### B.5.1.2.1 Functional Definition of Offline-Media Application Entity

Activation of the “Export to CD-R” icon or menu entry will pass the currently selected patients, studies, series or instances (images or presentation states) to the Offline-Media Application Entity. The SOP Instances associated with the selection will be collected into one or more export jobs. The contents of each export job will be written to a single CD-R media.

##### B.5.1.3 Sequencing of Real-World Activities

At least one image or presentation state must exist and be selected before the Offline-Media Application Entity can be invoked. The operator can insert a new CD-R media at any time before or after invocation of the Offline-Media Application Entity. The Offline-Media Application Entity will wait indefinitely for a media to be inserted before starting to write to the CD-R device. If no CD-R media is available the export job can be canceled from the job queue.

##### B.5.1.4 File Meta Information Options

The implementation information written to the File Meta Header in each file is:

**Table B.5.1-1  
DICOM IMPLEMENTATION CLASS AND VERSION FOR MEDIA STORAGE**

|                             |                              |
|-----------------------------|------------------------------|
| Implementation Class UID    | 1.xxxxxxx.yyy.etc.ad.inf.usw |
| Implementation Version Name | EXINTMOD_01                  |



## B.5.2 AE SPECIFICATIONS

### B.5.2.1 Offline-Media Application Entity Specification

The Offline-Media Application Entity provides standard conformance to the Media Storage Service Class. The Application Profiles and roles are listed below:

**Table B.5.2-1  
APPLICATION PROFILES, ACTIVITIES AND ROLES FOR OFFLINE-MEDIA**

| Application Profiles Supported | Real World Activity | Role |  |
|--------------------------------|---------------------|------|--|
| STD-GEN-CD                     | Export to CD-R      | FSC  |  |

#### B.5.2.1.1 File Meta Information for the Application Entity

The Source Application Entity Title included in the File Meta Header is configurable (see section 5.4).

#### B.5.2.1.2 Real-World Activities

##### B.5.2.1.2.1 Activity – Export to CD-R

The Offline-Media Application Entity acts as an FSC when requested to export SOP Instances from the local database to a CD-R medium.

A dialogue will be presented allowing the user to modify the suggested media label and provides control over the available media capacity. If the contents of the current selection do not fit on a single media an automatic separation into multiple export jobs will be suggested which can be adapted by the user.

The user will be prompted to insert an empty CD-R for each export job. The contents of the export job will be written together with a corresponding DICOMDIR to a single-session CDR. Writing in multi-session mode is not supported. The user can cancel an export job in the job queue.

##### B.5.2.1.2.1.1 Media Storage Application Profiles

The Offline-Media Application Entity support the STD-GEN-CD Application Profile.

##### B.5.2.1.2.1.1.1 Options

The Offline-Media Application Entity supports the SOP Classes and Transfer Syntaxes listed in the Table below:

**Table B.5.2-2  
IODS, SOP CLASSES AND TRANSFER SYNTAXES FOR OFFLINEMEDIA**

| Information Object Definition                 | SOP Class UID                | Transfer Syntax           | Transfer Syntax UID |
|-----------------------------------------------|------------------------------|---------------------------|---------------------|
| Media Storage Directory Storage               | 1.2.840.10008.1.3.10         | Explicit VR Little Endian | 1.2.840.10008.1.2.1 |
| X-Ray Radio Fluoroscopic Image Storage        | 1.2.840.10008.5.1.4.1.1.12.2 | Explicit VR Little Endian | 1.2.840.10008.1.2.1 |
| Grayscale Softcopy Presentation State Storage | 1.2.840.10008.5.1.4.1.1.11.1 | Explicit VR Little Endian | 1.2.840.10008.1.2.1 |

## B.5.3 AUGMENTED AND PRIVATE APPLICATION PROFILES

EXAMPLE-INTEGRATED-MODALITY does not support any augmented for private application profiles.

#### **B.5.4 MEDIA CONFIGURATION**

All local applications use the AE Titles configured via the Service/Installation Tool. The Application Entity Titles configurable for Media Services are listed in the Table below:

**Table B.5.4-1  
AE TITLE CONFIGURATION TABLE**

| <b>Application Entity</b> | <b>Default AE Title</b> |
|---------------------------|-------------------------|
| Offline-Media             | EXINTMOD_MEDIA          |

## **B.6 SUPPORT OF CHARACTER SETS**

All EXAMPLE-INTEGRATED-MODALITY DICOM applications support the

ISO\_IR 100 (ISO 8859-1:1987 Latin Alphabet No. 1 supplementary set)

ISO\_IR 144 (ISO 8859-5:1988 Latin/Cyrillic Alphabet supplementary set)

If the EXAMPLE-INTEGRATED-MODALITY is configured for Cyrillic character set support, ISO\_IR 144 will be used automatically.

## B.7 SECURITY

EXAMPLE-INTEGRATED-MODALITY does not support any specific security measures.

It is assumed that EXAMPLE-INTEGRATED-MODALITY is used within a secured environment. It is assumed that a secured environment includes at a minimum:

- a. Firewall or router protections to ensure that only approved external hosts have network access to EXAMPLEINTEGRATED-MODALITY.
- b. Firewall or router protections to ensure that EXAMPLEINTEGRATED-MODALITY only has network access to approved external hosts and services.
- c. Any communication with external hosts and services outside the locally secured environment use appropriate secure network channels (e.g. such as a Virtual Private Network (VPN))

Other network security procedures such as automated intrusion detection may be appropriate in some environments. Additional security features may be established by the local security policy and are beyond the scope of this conformance statement.

## B.8 ANNEXES

### B.8.1 IOD CONTENTS

#### B.8.1.1 Created SOP Instances

Examples of X-Ray Radiofluoroscopic images and Grayscale Softcopy Presentation States created by EXAMPLE-INTEGRATED-MODALITY can be downloaded from:

<http://www.example-imaging-products.nocom/example-integrated-modality/example-images>

Table B.8.1-1 specifies the attributes of an X-Ray Radiofluoroscopic Image transmitted by the EXAMPLE-INTEGRATED-MODALITY storage application.

Table B.8.1-2 specifies the attributes of a Grayscale Softcopy Presentation State transmitted by the EXAMPLEINTEGRATED-MODALITY storage application.

The following tables use a number of abbreviations. The abbreviations used in the "Presence of ..." column are:

|        |                                                                              |
|--------|------------------------------------------------------------------------------|
| VNAP   | Value Not Always Present (attribute sent zero length if no value is present) |
| ANAP   | Attribute Not Always Present                                                 |
| ALWAYS | Always Present                                                               |
| EMPTY  | Attribute is sent without a value                                            |

The abbreviations used in the "Source" column:

|        |                                                                                   |
|--------|-----------------------------------------------------------------------------------|
| MWL    | the attribute value source Modality Worklist                                      |
| USER   | the attribute value source is from User input                                     |
| AUTO   | the attribute value is generated automatically                                    |
| MPPS   | the attribute value is the same as that use for Modality Performed Procedure Step |
| CONFIG | the attribute value source is a configurable parameter                            |

NOTE: All dates and times are encoded in the local configured calendar and time. Date, Time and Time zone are configured using the Service/Installation Tool.

#### B.8.1.1.1 X-Ray Radiofluoroscopic Image IOD

**Table B.8.1-1**  
**IOD OF CREATED RF SOP INSTANCES**

| IE        | Module            | Reference     | Presence of Module |
|-----------|-------------------|---------------|--------------------|
| Patient   | Patient           | Table B.8.1-3 | ALWAYS             |
| Study     | General Study     | Table B.8.1-4 | ALWAYS             |
|           | Patient Study     | Table B.8.1-5 | ALWAYS             |
| Series    | General Series    | Table B.8.1-6 | ALWAYS             |
| Equipment | General Equipment | Table B.8.1-7 | ALWAYS             |
| Image     | General Image     | Table B.8.1-8 | ALWAYS             |

|  |                     |                |                                                         |
|--|---------------------|----------------|---------------------------------------------------------|
|  | Image Pixel         | Table B.8.1-10 | ALWAYS                                                  |
|  | Cine                | Table B.8.1-11 | Only if Multi-frame                                     |
|  | Multi-Frame         | Table B.8.1-12 | Only if Multi-frame                                     |
|  | Frame Pointers      | Table B.8.1-13 | Only if Multi-frame                                     |
|  | Mask                | Table B.8.1-14 | ALWAYS                                                  |
|  | X-Ray Image         | Table B.8.1-15 | ALWAYS                                                  |
|  | X-Ray Acquisition   | Table B.8.1-16 | ALWAYS                                                  |
|  | Modality LUT        | Table B.8.1-17 | Only if Pixel Intensity Relationship (0028,1040) is LOG |
|  | VOI LUT             | Table B.8.1-18 | ALWAYS                                                  |
|  | SOP Common          | Table B.8.1-19 | ALWAYS                                                  |
|  | Private Application | Table B.8.1-8  | ALWAYS                                                  |

**B.8.1.1.2 Grayscale Softcopy Presentation State IOD**

**Table B.8.1-2  
IOD OF CREATED GRAYSCALE SOFTCOPY PRESENTATION STATE SOP INSTANCES**

| <b>IE</b>           | <b>Module</b>             | <b>Reference</b> | <b>Presence of Module</b>               |
|---------------------|---------------------------|------------------|-----------------------------------------|
| Patient             | Patient                   | Table B.8.1-3    | ALWAYS                                  |
| Study               | General Study             | Table B.8.1-4    | ALWAYS                                  |
|                     | Patient Study             | Table B.8.1-5    | ALWAYS                                  |
| Series              | General Series            | Table B.8.1-6    | ALWAYS                                  |
|                     | Presentation Series       | Table B.8.1-20   | ALWAYS                                  |
| Equipment           | General Equipment         | Table B.8.1-7    | ALWAYS                                  |
| Presentation State  | Presentation State        | Table B.8.1-21   | ALWAYS                                  |
|                     | Display Shutter           | Table B.8.1-22   | Only if Shutter applied                 |
|                     | Displayed Area            | Table B.8.1-23   | ALWAYS                                  |
|                     | Graphic Annotation        | Table B.8.1-24   | Only if Graphic Annotations are present |
|                     | Spatial Transformation    | Table B.8.1-25   | Only if Spacial Transformation applied  |
|                     | Graphic Layer             | Table B.8.1-26   | Only if Graphic Annotations are present |
|                     | Modality LUT              | Table B.8.1-27   | ALWAYS                                  |
|                     | Softcopy VOI LUT          | Table B.8.1-28   | ALWAYS                                  |
|                     | Softcopy Presentation LUT | Table B.8.1-29   | ALWAYS                                  |
|                     | SOP Common                | Table B.8.1-19   | ALWAYS                                  |
| Private Application | Table B.8.1-8             | ALWAYS           |                                         |

**B.8.1.1.3 Common Modules**

**Table B.8.1-3  
PATIENT MODULE OF CREATED SOP INSTANCES**

| Attribute Name       | Tag         | VR | Value                                                                                                                                                                                                                 | Presence of Value | Source       |
|----------------------|-------------|----|-----------------------------------------------------------------------------------------------------------------------------------------------------------------------------------------------------------------------|-------------------|--------------|
| Patient's Name       | (0010,0010) | PN | From Modality Worklist or user input. Values supplied via Modality Worklist will be entered as received. Values supplied via user input will contain all 5 components (some possibly empty). . Maximum 64 characters. | VNAP              | MWL/<br>USER |
| Patient ID           | (0010,0020) | LO | From Modality Worklist or user input. Maximum 64 characters.                                                                                                                                                          | VNAP              | MWL/<br>USER |
| Patient's Birth Date | (0010,0030) | DA | From Modality Worklist or user input                                                                                                                                                                                  | VNAP              | MWL/<br>USER |
| Patient's Sex        | (0010,0040) | CS | From Modality Worklist or user input                                                                                                                                                                                  | VNAP              | MWL/<br>USER |
| Patient Comments     | (0010,4000) | LT | From User Input. Maximum 1024 characters.                                                                                                                                                                             | VNAP              | USER         |

**Table B.8.1-4  
GENERAL STUDY MODULE OF CREATED SOP INSTANCES**

| Attribute Name               | Tag         | VR | Value                                                    | Presence of Value | Source       |
|------------------------------|-------------|----|----------------------------------------------------------|-------------------|--------------|
| Study Instance UID           | (0020,000D) | UI | From Modality Worklist or generated by device            | ALWAYS            | MWL/<br>AUTO |
| Study Date                   | (0008,0020) | DA | <yyyymmdd>                                               | ALWAYS            | AUTO         |
| Study Time                   | (0008,0030) | TM | <hhmmss>                                                 | ALWAYS            | AUTO         |
| Referring Physician's Name   | (0008,0090) | PN | From Modality Worklist                                   | VNAP              | MWL          |
| Study ID                     | (0020,0010) | SH | Requested Procedure ID from Worklist or User Input       | VNAP              | MWL/<br>USER |
| Accession Number             | (0008,0050) | SH | From Modality Worklist or user input                     | VNAP              | MWL/<br>USER |
| Study Description            | (0008,1030) | LO | Comment text box in study list. Maximum 1024 characters. | VNAP              | USER         |
| Referenced Study Sequence    | (0008,1110) | SQ | From Modality Worklist                                   | VNAP              | MWL          |
| >Referenced SOP Class UID    | (0008,1150) | UI | From Modality Worklist                                   | VNAP              | MWL          |
| >Referenced SOP Instance UID | (0008,1155) | UI | From Modality Worklist                                   | VNAP              | MWL          |

**Table B.8.1-5  
PATIENT STUDY MODULE OF CREATED SOP INSTANCES**

| Attribute Name                  | Tag         | VR | Value                  | Presence of Value | Source |
|---------------------------------|-------------|----|------------------------|-------------------|--------|
| Admitting Diagnosis Description | (0008,1080) | LO | From Modality Worklist | VNAP              | MWL    |

|                  |             |    |                                                  |        |              |
|------------------|-------------|----|--------------------------------------------------|--------|--------------|
| Patient's Age    | (0010,1010) | AS | Calculated from DoB input on base of actual Date | ALWAYS | AUTO         |
| Patient's Weight | (0010,1030) | DS | From Modality Worklist or user input             | VNAP   | MWL/<br>USER |

**Table B.8.1-6  
GENERAL SERIES MODULE OF CREATED SOP INSTANCES**

| Attribute Name                               | Tag         | VR | Value                                                           | Presence of Value | Source |
|----------------------------------------------|-------------|----|-----------------------------------------------------------------|-------------------|--------|
| Modality                                     | (0008,0060) | CS | RF                                                              | ALWAYS            | AUTO   |
| Series Instance UID                          | (0020,000E) | UI | Generated by device                                             | ALWAYS            | AUTO   |
| Series Number                                | (0020,0011) | IS | Generated by device                                             | ALWAYS            | AUTO   |
| Series Date                                  | (0008,0021) | DA | <yyyymmdd>                                                      | ALWAYS            | AUTO   |
| Series Time                                  | (0008,0031) | TM | <hhmmss>                                                        | ALWAYS            | AUTO   |
| Performing Physician's Name                  | (0008,1050) | PN | Physician field in Study list. Maximum 64 characters.           | VNAP              | USER   |
| Protocol Name                                | (0018,1030) | LO | Organ program                                                   | ALWAYS            | AUTO   |
| Series Description                           | (0008,103E) | LO | Organ from Study list. Maximum 512 characters.                  | VNAP              | USER   |
| Operator's Name                              | (0008,1070) | PN | Operator field in Study list. Maximum 64 characters.            | VNAP              | USER   |
| Referenced Performed Procedure Step Sequence | (0008,1111) | SQ | Identifies the MPPS SOP Instance to which this image is related | ALWAYS            | MPPS   |
| >Referenced SOP Class UID                    | (0008,1150) | UI | MPPS SOP Class UID                                              | ALWAYS            | MPPS   |
| >Referenced SOP Instance UID                 | (0008,1155) | UI | MPPS SOP Instance UID                                           | ALWAYS            | MPPS   |
| Request Attributes Sequence                  | (0040,0275) | SQ | Zero or 1 item will be present                                  | ALWAYS            | AUTO   |
| >Requested Procedure ID                      | (0040,1001) | SH | From Modality Worklist                                          | VNAP              | MWL    |
| >Scheduled Procedure Step ID                 | (0040,0009) | SH | From Modality Worklist                                          | VNAP              | MWL    |
| >Scheduled Procedure Step Description        | (0040,0007) | LO | From Modality Worklist                                          | VNAP              | MWL    |
| >Scheduled Protocol Code Sequence            | (0040,0008) | SQ | From Modality Worklist                                          | VNAP              | MWL    |
| Performed Procedure Step ID                  | (0040,0253) | SH | Same as MPPS.                                                   | ALWAYS            | MPPS   |
| Performed Procedure Step Start Date          | (0040,0244) | DA | Same as MPPS                                                    | ALWAYS            | MPPS   |
| Performed Procedure Step Start Time          | (0040,0245) | TM | Same as MPPS                                                    | ALWAYS            | MPPS   |
| Performed Procedure Step Description         | (0040,0254) | LO | Same as MPPS. From user input. Maximum 64 characters.           | VNAP              | MPPS   |
| Performed Protocol Code Sequence             | (0040,0260) | SQ | Same as MPPS                                                    | ALWAYS            | MPPS   |



|                                          |             |    |                                                       |      |      |
|------------------------------------------|-------------|----|-------------------------------------------------------|------|------|
| Comments on the Performed Procedure Step | (0040,0280) | LO | Same as MPPS. From user input. Maximum 64 characters. | VNAP | MPPS |
|------------------------------------------|-------------|----|-------------------------------------------------------|------|------|

**Table B.8.1-7  
GENERAL EQUIPMENT MODULE OF CREATED SOP INSTANCES**

| Attribute Name            | Tag         | VR | Value                       | Presence of Value | Source |
|---------------------------|-------------|----|-----------------------------|-------------------|--------|
| Manufacturer              | (0008,0070) | LO | EXAMPLE-IMAGING-PRODUCTS    | ALWAYS            | AUTO   |
| Institution Name          | (0008,0080) | LO | From Configuration          | VNAP              | CONFIG |
| Station Name              | (0008,1010) | SH | From Configuration          | ALWAYS            | CONFIG |
| Manufacturer's Model Name | (0008,1090) | LO | EXAMPLE-INTEGRATED-MODALITY | ALWAYS            | AUTO   |
| Device Serial Number      | (0018,1000) | LO | From Configuration          | ALWAYS            | CONFIG |
| Software Version          | (0018,1020) | LO | From Configuration          | ALWAYS            | CONFIG |
| Private Creator           | (0009,00xx) | LO | EXINTMOD_EQ_01              | ALWAYS            | AUTO   |
| Equipment UID             | (0009,xx01) | UI | From Configuration          | ALWAYS            | CONFIG |
| Service UID               | (0009,xx02) | UI | From Configuration          | ALWAYS            | CONFIG |

**Table B.8.1-8  
PRIVATE APPLICATION MODULE OF CREATED SOP INSTANCES**

| Attribute Name               | Tag         | VR | Value                                                                                         | Presence of Value | Source |
|------------------------------|-------------|----|-----------------------------------------------------------------------------------------------|-------------------|--------|
| Private Creator              | (0029,10xx) | LO | EXINTMOD_IM_01                                                                                | ALWAYS            | AUTO   |
| Application Header Sequence  | (0029,xx40) | SQ | Zero or more items. Each item contains private application data from a different application. | VNAP              | AUTO   |
| > Application Header Type    | (0029,xx41) | CS | One of PLATFORM or PLUGIN                                                                     | ALWAYS            | AUTO   |
| > Application Header ID      | (0029,xx42) | LO | One of ACQUISITION, IMAGE PROCESSING, VIEWER, AUDIT, ACCESS, ROUTING or STATUS                | ALWAYS            | AUTO   |
| > Application Header Version | (0029,xx43) | LO | From Application                                                                              | ALWAYS            | AUTO   |
| > Application Header Data    | (0029,xx44) | OB | From Application                                                                              | ALWAYS            | AUTO   |
| Workflow Control Flags       | (0029,xx50) | LO | One or more of:<br>P: printed<br>com: completed<br>rea: read<br>ver: verified                 | VNAP              | AUTO   |

|                                          |             |    |                                                                             |        |      |
|------------------------------------------|-------------|----|-----------------------------------------------------------------------------|--------|------|
|                                          |             |    | RI: received<br>AC: archived and committed<br>E: exported<br>m: marked      |        |      |
| Archive Management Flag – Keep Online    | (0029,xx51) | CS | 00 = remote control not required (default)<br>01 = keep instance online.    | ALWAYS | AUTO |
| Archive Management Flag – Do Not Archive | (0029,xx52) | CS | 00 = remote control not required (default)<br>01 = do not archive instance. | ALWAYS | AUTO |

**B.8.1.1.4 X-Ray Radiofluoroscopic Image Modules**

**Table B.8.1-9  
GENERAL IMAGE MODULE OF CREATED RF SOP INSTANCES**

| Attribute Name                  | Tag         | VR | Value                                               | Presence of Value | Source |
|---------------------------------|-------------|----|-----------------------------------------------------|-------------------|--------|
| Instance Number                 | (0020,0013) | IS | Generated by device                                 | ALWAYS            | AUTO   |
| Patient Orientation             | (0020,0020) | CS | Zero length                                         | EMPTY             | AUTO   |
| Content Date                    | (0008,0023) | DA | <yyyymmdd>                                          | ALWAYS            | AUTO   |
| Content Time                    | (0008,0033) | TM | <hhmmss>                                            | ALWAYS            | AUTO   |
| Acquisition Number              | (0020,0012) | IS | Generated by device                                 | ALWAYS            | AUTO   |
| Image Comments                  | (0020,4000) | LT | From user input. Maximum 1024 characters.           | VNAP              | USER   |
| Anatomic Region Sequence        | (0008,2218) | SQ | From user input.                                    | ALWAYS            | USER   |
| > Include 'Code Sequence Macro' |             |    | Baseline Context ID is 4009 (see also section B8.6) |                   |        |

**Table B.8.1-10  
IMAGE PIXEL MODULE OF CREATED RF SOP INSTANCES**

| Attribute Name | Tag         | VR | Value                                                            | Presence of Value | Source |
|----------------|-------------|----|------------------------------------------------------------------|-------------------|--------|
| Pixel Data     | (7FE0,0010) | OW | The Pixel Data itself does not contain any burned-in annotation. | ALWAYS            | AUTO   |

**Table B.8.1-11  
CINE MODULE OF CREATED RF SOP**

| Attribute Name            | Tag         | VR | Value                                 | Presence of Value | Source |
|---------------------------|-------------|----|---------------------------------------|-------------------|--------|
| Frame Time                | (0018,1063) | DS | Only if multi-frame.                  | ANAP              | AUTO   |
| Recommended Display Frame | (0008,2144) | IS | Only if multi-frame Same as Cine Rate | ANAP              | AUTO   |

|           |             |    |                     |      |      |
|-----------|-------------|----|---------------------|------|------|
| Rate      |             |    |                     |      |      |
| Cine Rate | (0018,0040) | IS | Only if multi-frame | ANAP | AUTO |

**Table B.8.1-12**  
**MULTI-FRAME MODULE OF CREATED RF SOP INSTANCES**

| Attribute Name   | Tag         | VR | Value               | Presence of Value | Source |
|------------------|-------------|----|---------------------|-------------------|--------|
| Number of Frames | (0028,0008) | IS | Only if multi-frame | ANAP              | AUTO   |

**Table B.8.1-13**  
**FRAME POINTERS MODULE OF CREATED RF SOP INSTANCES**

| Attribute Name              | Tag         | VR | Value               | Presence of Value | Source |
|-----------------------------|-------------|----|---------------------|-------------------|--------|
| Representative Frame Number | (0028,6010) | US | Only if multi-frame | ANAP              | AUTO   |

**Table B.8.1-14**  
**MASK MODULE OF CREATED RF SOP INSTANCES**

| Attribute Name            | Tag         | VR | Value                                     | Presence of Value | Source |
|---------------------------|-------------|----|-------------------------------------------|-------------------|--------|
| Mask Subtraction Sequence | (0028,6100) | SQ | Only if multi-frame and (0028,1040) = LOG | ANAP              | AUTO   |
| > Mask Operation          | (0028,6101) | CS | AVG_SUB                                   | ANAP              | AUTO   |
| > Mask Frame Numbers      | (0028,6110) | US | Mask Frame Number                         | ANAP              | AUTO   |
| Recommended Viewing Mode  | (0028,1090) | CS | NAT or SUB                                | ALWAYS            | AUTO   |

**Table B.8.1-15**  
**X-RAY IMAGE MODULE OF CREATED RF SOP INSTANCES**

| Attribute Name               | Tag         | VR | Value                                                                                                              | Presence of Value | Source |
|------------------------------|-------------|----|--------------------------------------------------------------------------------------------------------------------|-------------------|--------|
| Frame Increment Pointer      | (0028,0009) | AT | <0018,1063> only if multi-frame                                                                                    | ANAP              | AUTO   |
| Image Type                   | (0008,0008) | CS | ORIGINAL\PRIMARY\SINGLE PLANE\DAS<br>(acquired images)<br>ORIGINAL\DERIVED\SINGLE PLANE<br>(post-processed images) | ALWAYS            | AUTO   |
| Pixel Intensity Relationship | (0028,1040) | CS | LIN or LOG                                                                                                         | ALWAYS            | AUTO   |
| Samples per Pixel            | (0028,0002) | US | 1                                                                                                                  | ALWAYS            | AUTO   |

|                            |             |    |             |        |      |
|----------------------------|-------------|----|-------------|--------|------|
| Photometric Interpretation | (0028,0004) | CS | MONOCHROME2 | ALWAYS | AUTO |
| Rows                       | (0028,0010) | US | 1024        | ALWAYS | AUTO |
| Columns                    | (0028,0011) | US | 1024        | ALWAYS | AUTO |
| Bits Allocated             | (0028,0100) | US | 16          | ALWAYS | AUTO |
| Bits Stored                | (0028,0101) | US | 10          | ALWAYS | AUTO |
| High Bit                   | (0028,0102) | US | 9           | ALWAYS | AUTO |
| Pixel Representation       | (0028,0103) | US | 0000H       | ALWAYS | AUTO |

**Table B.8.1.16**  
**X-RAY ACQUISITION MODULE OF CREATED RF SOP INSTANCES**

| Attribute Name           | Tag         | VR | Value                       | Presence of Value | Source |
|--------------------------|-------------|----|-----------------------------|-------------------|--------|
| KVP                      | (0018,0060) | DS | From Acquisition parameters | ALWAYS            | AUTO   |
| Radiation Setting        | (0018,1155) | CS | GR                          | ALWAYS            | AUTO   |
| X-Ray Tube Current       | (0018,1151) | IS | From Acquisition parameters | ALWAYS            | AUTO   |
| Exposure Time            | (0018,1150) | IS | From Acquisition parameters | ALWAYS            | AUTO   |
| Radiation Mode           | (0018,115A) | CS | CONTINUOUS                  | ALWAYS            | AUTO   |
| Intensifier Size         | (0018,1162) | DS | From Acquisition parameters | ALWAYS            | AUTO   |
| Private Creator          | (0019,10xx) | LO | EXINTMOD_AQ_01              | ALWAYS            | AUTO   |
| Edge Enhancement Percent | (0019,xx10) | IS | 0 .. 100                    | VNAP              | AUTO   |
| Landmark                 | (0019,xx20) | IS | 0 .. 100                    | VNAP              | AUTO   |
| Pixel Shift Horizontal   | (0019,xx30) | DS | -20 .. +20                  | VNAP              | AUTO   |
| Pixel Shift Vertical     | (0019,xx40) | DS | -20 .. +20                  | VNAP              | AUTO   |

**Table B.8.1-17**  
**MODALITY LUT MODULE OF CREATED RF SOP INSTANCES**

| Attribute Name        | Tag         | VR | Value                        | Presence of Value | Source |
|-----------------------|-------------|----|------------------------------|-------------------|--------|
| Modality LUT Sequence | (0028,3000) | SQ | present if (0028,1040) = LOG | ANAP              | AUTO   |
| > LUT Descriptor      | (0028,3002) | US | <1024,0,16>                  | ANAP              | AUTO   |
| > Modality LUT Type   | (0028,3004) | LO | US                           | ANAP              | AUTO   |
| > LUT Data            | (0028,3006) | US | LUT                          | ANAP              | AUTO   |

**Table B.8.1-18  
VOI LUT MODULE OF CREATED RF SOP INSTANCES**

| Attribute Name | Tag         | VR | Value    | Presence of Value | Source |
|----------------|-------------|----|----------|-------------------|--------|
| Window Center  | (0028,1050) | DS | 0...1023 | ALWAYS            | AUTO   |
| Window Width   | (0028,1051) | DS | 1...1024 | ALWAYS            | AUTO   |

**Table B.8.1-19  
SOP COMMON MODULE OF CREATED RF SOP INSTANCES**

| Attribute Name         | Tag         | VR | Value                        | Presence of Value | Source |
|------------------------|-------------|----|------------------------------|-------------------|--------|
| Specific Character Set | (0008,0005) | CS | "ISO_IR 100" or "ISO_IR 144" | ALWAYS            | CONFIG |
| SOP Class UID          | (0008,0016) | UI | 1.2.840.10008.5.1.4.1.1.12.2 | ALWAYS            | AUTO   |
| SOP Instance UID       | (0008,0018) | UI | Generated by device          | ALWAYS            | AUTO   |

**B.8.1.1.5 Grayscale Softcopy Presentation State Modules**

**Table B.8.1-20  
PRESENTATION SERIES MODULE OF CREATED GSPS SOP INSTANCES**

| Attribute Name | Tag         | VR | Value | Presence of Value | Source |
|----------------|-------------|----|-------|-------------------|--------|
| Modality       | (0008,0060) | CS | PR    | ALWAYS            | AUTO   |

**Table B.8.1-21  
PRESENTATION STATE MODULE OF CREATED GSPS SOP INSTANCES**

| Attribute Name              | Tag         | VR | Value                                                   | Presence of Value | Source |
|-----------------------------|-------------|----|---------------------------------------------------------|-------------------|--------|
| Instance Number             | (0020,0013) | IS | Generated by device                                     | ALWAYS            | AUTO   |
| Presentation Label          | (0070,0080) | CS | From user input.                                        | ALWAYS            | USER   |
| Presentation Description    | (0070,0081) | LO | From user input.                                        | VNAP              | USER   |
| Presentation Creation Date  | (0070,0082) | DA | Generated by device                                     | ALWAYS            | AUTO   |
| Presentation Creation Time  | (0070,0083) | TM | Generated by device                                     | ALWAYS            | AUTO   |
| Presentation Creator's Name | (0070,0084) | PN | Generated by device according to currently active user. | ALWAYS            | AUTO   |
| Referenced                  | (0008,1115) | SQ | One or more items.                                      | ALWAYS            | AUTO   |

|                               |             |    |                                           |        |      |
|-------------------------------|-------------|----|-------------------------------------------|--------|------|
| Series Sequence               |             |    |                                           |        |      |
| >Series Instance UID          | (0020,000E) | UI | From referenced image                     | ALWAYS | AUTO |
| >Referenced Image Sequence    | (0008,1140) | SQ | From referenced image                     | ALWAYS | AUTO |
| >>Referenced SOP Class UID    | (0008,1150) | UI | From referenced image                     | ALWAYS | AUTO |
| >>Referenced SOP Instance UID | (0008,1155) | UI | From referenced image                     | ALWAYS | AUTO |
| >>Referenced Frame Number     | (0008,1160) | IS | If referenced image is a multiframe image | ANAP   | AUTO |
| Shutter Presentation Value    | (0018,1622) | US | Generated by device if shutter present    | ANAP   | AUTO |

**Table B.8.1-22  
DISPLAY SHUTTER MODULE OF CREATED GSPS SOP INSTANCES**

| Attribute Name                | Tag         | VR | Value                                       | Presence of Value | Source |
|-------------------------------|-------------|----|---------------------------------------------|-------------------|--------|
| Shutter Shape                 | (0018,1600) | CS | If shutter applied:<br>RECTANGULAR\CIRCULAR | ANAP              | AUTO   |
| Shutter Left Vertical Edge    | (0018,1602) | IS | If RECTANGULAR shutter applied              | ANAP              | AUTO   |
| Shutter Right Vertical Edge   | (0018,1604) | IS | If RECTANGULAR shutter applied              | ANAP              | AUTO   |
| Shutter Upper Horizontal Edge | (0018,1606) | IS | If RECTANGULAR shutter applied              | ANAP              | AUTO   |
| Shutter Lower Horizontal Edge | (0018,1608) | IS | If RECTANGULAR shutter applied              | ANAP              | AUTO   |
| Center of Circular Shutter    | (0018,1610) | IS | If CIRCULAR shutter applied                 | ANAP              | AUTO   |
| Radius of Circular Shutter    | (0018,1612) | IS | If CIRCULAR shutter applied                 | ANAP              | AUTO   |

**Table B.8.1.23  
DISPLAYED AREA MODULE OF CREATED GSPS SOP INSTANCES**

| Attribute Name                    | Tag         | VR | Value                 | Presence of Value | Source |
|-----------------------------------|-------------|----|-----------------------|-------------------|--------|
| Displayed Area Selection Sequence | (0070,005A) | SQ | One or more items     | ALWAYS            | AUTO   |
| >Referenced Image Sequence        | (0008,1140) | SQ | One or more items     | ALWAYS            | AUTO   |
| >>Referenced SOP Class UID        | (0008,1150) | UI | From referenced image | ALWAYS            | AUTO   |
| >>Referenced SOP Instance UID     | (0008,1155) | UI | From referenced image | ALWAYS            | AUTO   |

|                                          |             |    |                                           |        |      |
|------------------------------------------|-------------|----|-------------------------------------------|--------|------|
| >>Referenced Frame Number                | (0008,1160) | IS | If referenced image is a multiframe image | ANAP   | AUTO |
| >Displayed Area Top Left Hand Corner     | (0070,0052) | SL | From current display setting              | ALWAYS | AUTO |
| >Displayed Area Bottom Right Hand Corner | (0070,0053) | SL | From current display setting              | ALWAYS | AUTO |
| >Presentation Size Mode                  | (0070,0100) | CS | From current display setting              | ALWAYS | AUTO |
| >Presentation Pixel Spacing              | (0070,0101) | DS | From current display setting              | ANAP   | AUTO |
| >Presentation Pixel Aspect Ratio         | (0070,0102) | IS | From current display setting              | ANAP   | AUTO |
| >Presentation Pixel Magnification Ratio  | (0070,0103) | FL | From current display setting              | ANAP   | AUTO |

**Table B.8.1-24**  
**GRAPHIC ANNOTATION MODULE OF CREATED GSPS SOP INSTANCES**

| Attribute Name                  | Tag         | VR | Value                                           | Presence of Value | Source |
|---------------------------------|-------------|----|-------------------------------------------------|-------------------|--------|
| Graphic Annotation Sequence     | (0070,0001) | SQ | One or more items                               | ANAP              | AUTO   |
| >Referenced Image Sequence      | (0008,1140) | SQ | One or more items                               | ALWAYS            | AUTO   |
| >>Referenced SOP Class UID      | (0008,1150) | UI | From referenced image                           | ALWAYS            | AUTO   |
| >>Referenced SOP Instance UID   | (0008,1155) | UI | From referenced image                           | ALWAYS            | AUTO   |
| >>Referenced Frame Number       | (0008,1160) | IS | If referenced image is a multiframe image       | ANAP              | AUTO   |
| >Graphic Layer                  | (0070,0002) | CS | Layer in Graphic Layer Module                   | ALWAYS            | AUTO   |
| >Text Object Sequence           | (0070,0008) | SQ | One or more items if text annotation present    | ANAP              | AUTO   |
| >>Anchor Point Annotation Units | (0070,0004) | CS | PIXEL                                           | ALWAYS            | AUTO   |
| >>Unformatted Text Value        | (0070,0006) | ST | From user input                                 | ALWAYS            | USER   |
| >>Anchor Point                  | (0070,0014) | FL | From user input                                 | ALWAYS            | USER   |
| >>Anchor Point Visibility       | (0070,0015) | CS | From user input                                 | ALWAYS            | USER   |
| >Graphic Object Sequence        | (0070,0009) | SQ | One or more items if graphic annotation present | ANAP              | AUTO   |
| >>Graphic Annotation Units      | (0070,0005) | CS | PIXEL                                           | ALWAYS            | AUTO   |
| >>Graphic Dimensions            | (0070,0020) | US | 2                                               | ALWAYS            | AUTO   |
| >>Number of Graphic Points      | (0070,0021) | US | From user input                                 | ALWAYS            | USER   |
| >>Graphic Data                  | (0070,0022) | FL | From user input                                 | ALWAYS            | USER   |

|                                 |             |    |                                                         |                   |        |
|---------------------------------|-------------|----|---------------------------------------------------------|-------------------|--------|
| >>Graphic Type                  | (0070,0023) | CS | One of POINT, POLYLINE, INTERPOLATED, CIRCLE or ELLIPSE | ALWAYS            | USER   |
| >>Graphic Filled                | (0070,0024) | CS | From user input                                         | ANAP              | USER   |
| Attribute Name                  | Tag         | VR | Value                                                   | Presence of Value | Source |
| Graphic Annotation Sequence     | (0070,0001) | SQ | One or more items                                       | ANAP              | AUTO   |
| >Referenced Image Sequence      | (0008,1140) | SQ | One or more items                                       | ALWAYS            | AUTO   |
| >>Referenced SOP Class UID      | (0008,1150) | UI | From referenced image                                   | ALWAYS            | AUTO   |
| >>Referenced SOP Instance UID   | (0008,1155) | UI | From referenced image                                   | ALWAYS            | AUTO   |
| >>Referenced Frame Number       | (0008,1160) | IS | If referenced image is a multiframe image               | ANAP              | AUTO   |
| >Graphic Layer                  | (0070,0002) | CS | Layer in Graphic Layer Module                           | ALWAYS            | AUTO   |
| >Text Object Sequence           | (0070,0008) | SQ | One or more items if text annotation present            | ANAP              | AUTO   |
| >>Anchor Point Annotation Units | (0070,0004) | CS | PIXEL                                                   | ALWAYS            | AUTO   |
| >>Unformatted Text Value        | (0070,0006) | ST | From user input                                         | ALWAYS            | USER   |
| >>Anchor Point                  | (0070,0014) | FL | From user input                                         | ALWAYS            | USER   |
| >>Anchor Point Visibility       | (0070,0015) | CS | From user input                                         | ALWAYS            | USER   |
| >Graphic Object Sequence        | (0070,0009) | SQ | One or more items if graphic annotation present         | ANAP              | AUTO   |
| >>Graphic Annotation Units      | (0070,0005) | CS | PIXEL                                                   | ALWAYS            | AUTO   |
| >>Graphic Dimensions            | (0070,0020) | US | 2                                                       | ALWAYS            | AUTO   |
| >>Number of Graphic Points      | (0070,0021) | US | From user input                                         | ALWAYS            | USER   |
| >>Graphic Data                  | (0070,0022) | FL | From user input                                         | ALWAYS            | USER   |
| >>Graphic Type                  | (0070,0023) | CS | One of POINT, POLYLINE, INTERPOLATED, CIRCLE or ELLIPSE | ALWAYS            | USER   |
| >>Graphic Filled                | (0070,0024) | CS | From user input                                         | ANAP              | USER   |

**Table B.8.1-25  
SPATIAL TRANSFORMATION MODULE OF CREATED GSPS SOP INSTANCES**

| Attribute Name | Tag         | VR | Value                        | Presence of Value | Source |
|----------------|-------------|----|------------------------------|-------------------|--------|
| Image Rotation | (0070,0042) | US | From current display setting | ANAP              | AUTO   |
| Image          | (0070,0041) | CS | From current display setting | ANAP              | AUTO   |



|                 |  |  |  |  |  |
|-----------------|--|--|--|--|--|
| Horizontal Flip |  |  |  |  |  |
|-----------------|--|--|--|--|--|

**Table 8.1-26  
GRAPHIC LAYER MODULE OF CREATED GSPS SOP INSTANCES**

| Attribute Name         | Tag         | VR | Value                        | Presence of Value | Source |
|------------------------|-------------|----|------------------------------|-------------------|--------|
| Graphic Layer Sequence | (0070,0060) | SQ | One or more items            | ANAP              | AUTO   |
| >Graphic Layer         | (0070,0002) | CS | LAYER1. LAYER2, LAYER3, ...  | ALWAYS            | AUTO   |
| >Graphic Layer Order   | (0070,0062) | IS | From current display setting | ALWAYS            | AUTO   |

**Table B.8.1-27  
MODALITY LUT MODULE OF CREATED GSPS SOP INSTANCES**

| Attribute Name        | Tag         | VR | Value       | Presence of Value | Source |
|-----------------------|-------------|----|-------------|-------------------|--------|
| Modality LUT Sequence | (0028,3000) | SQ | One item    | ANAP              | AUTO   |
| >LUT Descriptor       | (0028,3002) | US | <1024,0,16> | ALWAYS            | AUTO   |
| >Modality LUT Type    | (0028,3004) | LO | US          | ALWAYS            | AUTO   |
| >LUT Data             | (0028,3006) | US | LUT         | ALWAYS            | AUTO   |
| Rescale Intercept     | (0028,1052) | DS | 1           | ANAP              | AUTO   |
| Rescale Slope         | (0028,1053) | DS | 0           | ANAP              | AUTO   |
| Rescale Type          | (0028,1054) | LO | US          | ANAP              | AUTO   |

**Table B.8.1-28  
SOFTCOPY VOI LUT MODULE OF CREATED GSPS SOP INSTANCES**

| Attribute Name                | Tag         | VR | Value                                     | Presence of Value | Source |
|-------------------------------|-------------|----|-------------------------------------------|-------------------|--------|
| Softcopy VOI LUT Sequence     | (0028,3110) | SQ | One or more items                         | ALWAYS            | AUTO   |
| >Referenced Image Sequence    | (0008,1140) | SQ | One or more items                         | ALWAYS            | AUTO   |
| >>Referenced SOP Class UID    | (0008,1150) | UI | From referenced image                     | ALWAYS            | AUTO   |
| >>Referenced SOP Instance UID | (0008,1155) | UI | From referenced image                     | ALWAYS            | AUTO   |
| >>Referenced Frame Number     | (0008,1160) | IS | If referenced image is a multiframe image | ANAP              | AUTO   |

|                                    |             |    |                                        |        |      |
|------------------------------------|-------------|----|----------------------------------------|--------|------|
| >Window Center                     | (0028,1050) | DS | From current display setting: 0...1023 | ALWAYS | AUTO |
| >Window Width                      | (0028,1051) | DS | From current display setting: 1...1024 | ALWAYS | AUTO |
| >Window Center & Width Explanation | (0028,1055) | LO | Name of Window Preset                  | ANAP   | AUTO |

**Table B.8.1-29  
SOFTCOPY PRESENTATION LUT MODULE OF CREATED GSPS SOP INSTANCES**

| Attribute Name         | Tag         | VR | Value    | Presence of Value | Source |
|------------------------|-------------|----|----------|-------------------|--------|
| Presentation LUT Shape | (2050,0020) | CS | IDENTITY | ALWAYS            | AUTO   |

**Table B.8.1-30  
SOP COMMON MODULE OF CREATED GSPS SOP INSTANCES**

| Attribute Name         | Tag         | VR | Value                        | Presence of Value | Source |
|------------------------|-------------|----|------------------------------|-------------------|--------|
| Specific Character Set | (0008,0005) | CS | "ISO_IR 100" or "ISO_IR 144" | ALWAYS            | CONFIG |
| SOP Class UID          | (0008,0016) | UI | 1.2.840.10008.5.1.4.1.1.11.1 | ALWAYS            | AUTO   |
| SOP Instance UID       | (0008,0018) | UI | Generated by device          | ALWAYS            | AUTO   |

**B.8.1.2 Used Fields in received IOD by application**

The EXAMPLE-INTEGRATED-MODALITY storage application does not receive SOP Instances. The usage of attributes received via Modality Worklist is described in section 4.2.2.3.1.3.

**B.8.1.3 Attribute mapping**

The relationships between attributes received via Modality Worklist, stored in acquired images and communicated via MPPS are summarized in Table B.8.1-31. The format and conventions used in Table 99Table 99 are the same as the corresponding table in DICOM Part 4, Annex M.6 [DICOM].

**Table B.8.1-31  
ATTRIBUTE MAPPING BETWEEN MODALITY WORKLIST, IMAGE AND MPPS**

| Modality Worklist          | Image IOD                  | MPPS IOD                           |
|----------------------------|----------------------------|------------------------------------|
| Patient Name               | Patient Name               | Patient Name                       |
| Patient ID                 | Patient ID                 | Patient ID                         |
| Patient's Birth Date       | Patient's Birth Date       | Patient's Birth Date               |
| Patient's Sex              | Patient's Sex              | Patient's Sex                      |
| Patient's Weight           | Patient's Weight           |                                    |
| Referring Physician's Name | Referring Physician's Name |                                    |
| ----                       | ----                       | Scheduled Step Attributes Sequence |

|                                       |                                          |                                          |
|---------------------------------------|------------------------------------------|------------------------------------------|
| Study Instance UID                    | Study Instance UID                       | >Study Instance UID                      |
| Referenced Study Sequence             | Referenced Study Sequence                | >Referenced Study Sequence               |
| Accession Number                      | Accession Number                         | >Accession Number                        |
| ----                                  | Request Attributes Sequence              | ----                                     |
| Requested Procedure ID                | >Requested Procedure ID                  | >Requested Procedure ID                  |
| Requested Procedure Description       |                                          | >Requested Procedure Description         |
| Scheduled Procedure Step ID           | >Scheduled Procedure Step ID             | >Scheduled Procedure Step ID             |
| Scheduled Procedure Step Description  | >Scheduled Procedure Step Description    | >Scheduled Procedure Step Description    |
| Scheduled Protocol Code Sequence      | >Scheduled Protocol Code Sequence        | ----                                     |
| ----                                  | Performed Protocol Code Sequence         | Performed Protocol Code Sequence         |
| ----                                  | Study ID                                 | Study ID                                 |
| ----                                  | Performed Procedure Step ID              | Performed Procedure Step ID              |
| ----                                  | Performed Procedure Step Start Date      | Performed Procedure Step Start Date      |
| ----                                  | Performed Procedure Step Start Time      | Performed Procedure Step Start Time      |
| ----                                  | Performed Procedure Step Description     | Performed Procedure Step Description     |
| ----                                  | Comments on the Performed Procedure Step | Comments on the Performed Procedure Step |
| ----                                  | ----                                     | Performed Series Sequence                |
| Scheduled Performing Physician's Name | Performing Physician's Name              | >Performing Physician's Name             |
| Requested Procedure Code Sequence     | ----                                     | Procedure Code Sequence                  |
| ----                                  | Referenced Study Component Sequence      | ----                                     |
| ----                                  | >Referenced SOP Class UID                | SOP Class UID                            |
| ----                                  | >Referenced SOP Instance UID             | SOP Instance UID                         |
| ----                                  | Protocol Name                            | Protocol Name                            |

#### B.8.1.4 Coerced/Modified Fields

The Modality Worklist AE will truncate attribute values received in the response to a Modality Worklist Query if the value length is longer than the maximum length permitted by the attribute's VR.

#### B.8.2 DATA DICTIONARY OF PRIVATE ATTRIBUTES

The Private Attributes added to created SOP Instances are listed in the Table below. EXAMPLE-INTEGRATED-MODALITY reserves blocks of private attributes in groups 0009, 0019 and 0029. Further details on usage of these private attributes are contained in Section 8.1.

**Table B.8.2-1  
DATA DICTIONARY OF PRIVATE ATTRIBUTES**

- Standard -

| Tag         | Attribute Name                           | VR | VM |
|-------------|------------------------------------------|----|----|
| (0009,00xx) | Private Creator                          | LO | 1  |
| (0009,xx01) | Equipment UID                            | UI | 1  |
| (0009,xx02) | Service UID                              | UI | 1  |
| (0019,00xx) | Private Creator                          | LO | 1  |
| (0019,xx10) | Edge Enhancement Percent                 | IS | 1  |
| (0019,xx20) | Landmark                                 | IS | 1  |
| (0019,xx30) | Pixel Shift Horizontal                   | DS | 1  |
| (0019,xx40) | Pixel Shift Vertical                     | DS | 1  |
| (0029,00xx) | Private Creator                          | LO | 1  |
| (0029,xx40) | Application Header Sequence              | SQ | 1  |
| (0029,xx41) | Application Header Type                  | CS | 1  |
| (0029,xx42) | Application Header ID                    | LO | 1  |
| (0029,xx43) | Application Header Version               | LO | 1  |
| (0029,xx44) | Application Header Data                  | OB | 1  |
| (0029,xx50) | Workflow Control Flags                   | LO | 8  |
| (0029,xx51) | Archive Management Flag – Keep Online    | CS | 1  |
| (0029,xx52) | Archive Management Flag – Do Not Archive | CS | 1  |

### B.8.3 CODED TERMINOLOGY AND TEMPLATES

The Workflow AE is capable of supporting arbitrary coding schemes for Procedure and Protocol Codes. The contents of Requested Procedure Code Sequence (0032,1064) and Scheduled Protocol Code Sequence (0040,0008) supplied in Worklist Items will be mapped to Image IOD and MPPS attributes as described in Table B.8.1-31. During installation, a service technician will establish a mapping between the site-specific codes and the Protocol Names used internally to identify acquisition protocols.

The contents of Anatomic Region Sequence (0008,2218) in generated images will be filled with an anatomic code selected by the user from a catalog. The default catalog of anatomic codes corresponds to Context Group 4009 but can be extended using the Service/Installation Tool.

The contents of Performed Procedure Step Discontinuation Reason Code Sequence (0040,0281) for a discontinued MPPS will be filled with a code selected by the user from a fixed list corresponding to Context Group 9300.

### B.8.4 GRAYSCALE IMAGE CONSISTENCY

The high resolution display monitor attached to EXAMPLEINTEGRATED-MODALITY can be calibrated according to the Grayscale Standard Display Function (GSDF). The Service/Installation Tool is used together with a luminance meter to measure the Characteristic Curve of the display system and the current ambient light. See the EXAMPLE-INTEGRATED-MODALITY Service Manual for details on the calibration procedure and supported calibration hardware. The result of the calibration procedure is a Monitor Correction LUT that will be active within the display subsystem after a system reboot.

### B.8.5 STANDARD EXTENDED / SPECIALIZED / PRIVATE SOP CLASSES

No Specialized or Private SOP Classes are supported.

#### **B.8.5.1 X-Ray Radiofluoroscopic Image Storage SOP Class**

The X-Ray Radiofluoroscopic Image Storage SOP Class is extended to create a Standard Extended SOP Class by addition of standard and private attributes to the created SOP Instances as documented in section 8.1.

#### **B.8.6 PRIVATE TRANSFER SYNTAXES**

No Private Transfer Syntaxes are supported.

**ANNEX C (Informative) CONFORMANCE STATEMENT  
SAMPLE DICOMRIS INTERFACE**

Disclaimer:

This document is an example DICOM Conformance Statement for a product that supports DICOM SOP Classes frequently associated with a Radiology Information System or RIS. The product whose conformance is being documented, DICOMRIS, and the manufacturer, Hospital Systems, are fictional.

As stated in the annex title, this document is truly informative, and not normative. A conformance statement of an actual product might implement additional services and options as appropriate for its specific purpose. In addition, an actual product might implement the services described in a different manner and, for example, with different characteristics and/or sequencing of activities. In other words, this conformance statement example does not intend to standardize a particular manner that a product might implement DICOM functionality.

**C.0 COVER PAGE**

Company Name: EXAMPLE RIS Products.

Product Name: SAMPLE DICOMRis Interface

Version: 1.0-rev. A.1

Internal document number: 4226-xxx-yyy-zzz rev 1

Date: YYYYMMDD

### C.1 CONFORMANCE STATEMENT OVERVIEW

Hospital Systems' DICOMRIS is a suite of applications that implement a full-featured Radiology Information System (RIS). DICOMRIS includes features typically associated with a RIS, including interfaces to various Hospital Information Systems, Patient Tracking, Results Reporting, Film Tracking, Management Reporting, PACS Integration, etc. The DICOMRIS GUI-based client application, RisView, runs on a Windows 95/98/NT platform; the server platform is Digital Unix.

As part of PACS Integration DICOMRIS supports several DICOM Service Classes, using DICOMTool's DICOM Toolkit, to provide the following capabilities:

Allowing Modalities to query for worklists of procedures to be performed and for patient and procedure demographics. DICOMRIS processes these queries by directly accessing the DICOMRIS database, which is automatically updated with appropriate data through the normal operations of the RIS.

Updating the DICOMRIS database in response to Procedure Step transactions initiated by Modalities as they perform examinations. Relevant data contained in these transactions may be viewed using RisView.

**Table C.1-1  
NETWORK SERVICES**

| <b>SOP Classes</b>                | <b>User of Service (SCU)</b> | <b>Provider of Service (SCP)</b> |
|-----------------------------------|------------------------------|----------------------------------|
| <b>Workflow Management</b>        |                              |                                  |
| Modality Worklist                 | No                           | Yes                              |
| Modality Performed Procedure Step | No                           | Yes                              |



## **C.2 TABLE OF CONTENTS**

A table of contents shall be provided to assist readers in easily finding the needed information.

## C.3 INTRODUCTION

### C.3.1 REVISION HISTORY

| Document Version | Revision Date    | Revision Author | Revision Description   |
|------------------|------------------|-----------------|------------------------|
| 1.1              | October 30, 2003 | WG 6            | Version for Final Text |
| 1.2              | August 30, 2007  | WG 6            | Revised Introduction   |

### C.3.2 AUDIENCE, REMARKS, TERMS AND DEFINITIONS, BASICS OF DICOM COMMUNICATION, ABBREVIATIONS, REFERENCES

*See example text in Annex A.3.*

### C.3.3 ADDITIONAL REFERENCES FOR THIS EXAMPLE

IHE Radiology Technical Framework, Revision 7.0, ACC/HIMSS/RSNA, 2006

CPT 2002 Professional Edition, American Medical Association, 2001

### C.3.4 ADDITIONAL REMARKS AND DEFINITIONS FOR THIS EXAMPLE

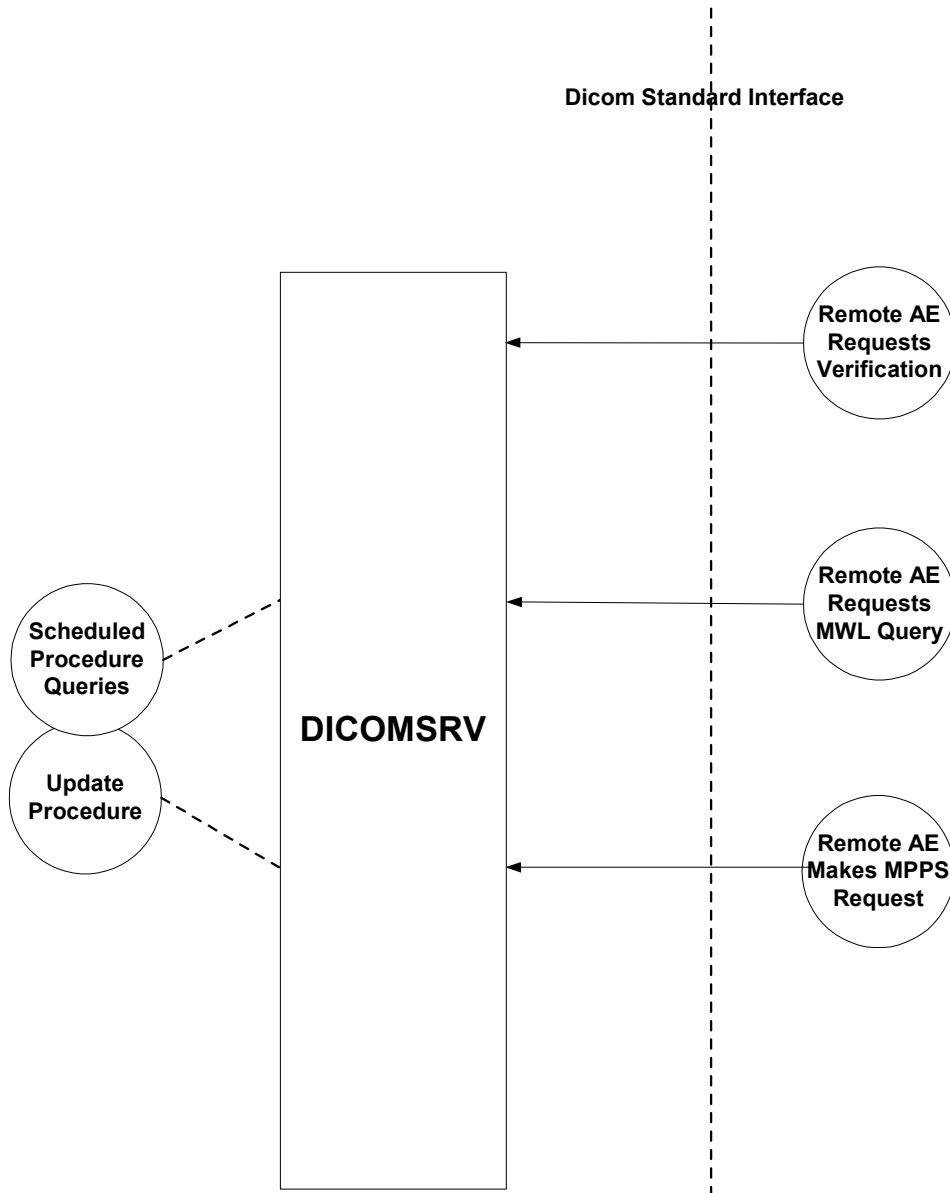
This document is a sample DICOM Conformance Statement created for DICOM PS3.2. It is to be used solely as an example to illustrate how to create a DICOM Conformance Statement for a departmental information system supporting DICOM Modality Worklist and Modality Performed Procedure Step Services. The subject of the document, DICOMRis, is a fictional product.

|                   |                                                                                                       |
|-------------------|-------------------------------------------------------------------------------------------------------|
| DICOMRis Database | The database that indexes procedures, orders and patients                                             |
| DICOMSRV          | DICOM MWL and MPPS application                                                                        |
| RisView           | DICOMRis' GUI-based application providing views into the DICOMRis' Database, reporting function, etc. |

## C.4 NETWORKING

### C.4.1 IMPLEMENTATION MODEL

#### C.4.1.1 Application Data Flow



**Figure C.4.1-1**  
**DICOM STANDARD INTERFACE**

The DICOMRIS DICOMSRV application provides access to Scheduled Procedure information, supports updating of the RIS database as procedures are performed. The various flows in the diagram above are described as follows

DICOMSRV accepts associations for Verification from Verification SCUs and responds automatically with Success status

DICOMSRV accepts Association Requests for Modality Worklist from MWL SCUs and responds to queries from these SCUs. When a query is received DICOMSRV engages in local real-world activity Scheduled Procedure Queries. This results in a set of matching responses that DICOMSRV returns to the MWL SCU.

DICOMSRV accepts Association Requests for Modality Performed Procedure Step from MPPS SCUs and responds to N-CREATE and N-SET Requests from these SCUs. When an N-CREATE or N-SET is received DICOMSRV engages in local real-world activity Update Procedure. This results in updates to the DICOMRIS Database per the contents of the received message. DICOMSRV then returns N-SET or N-CREATE status to the MPPS SCU.

#### **C.4.1.2 Functional Definition of AEs**

##### **C.4.1.2.1 Functional Definition of DICOMSRV Application Entity**

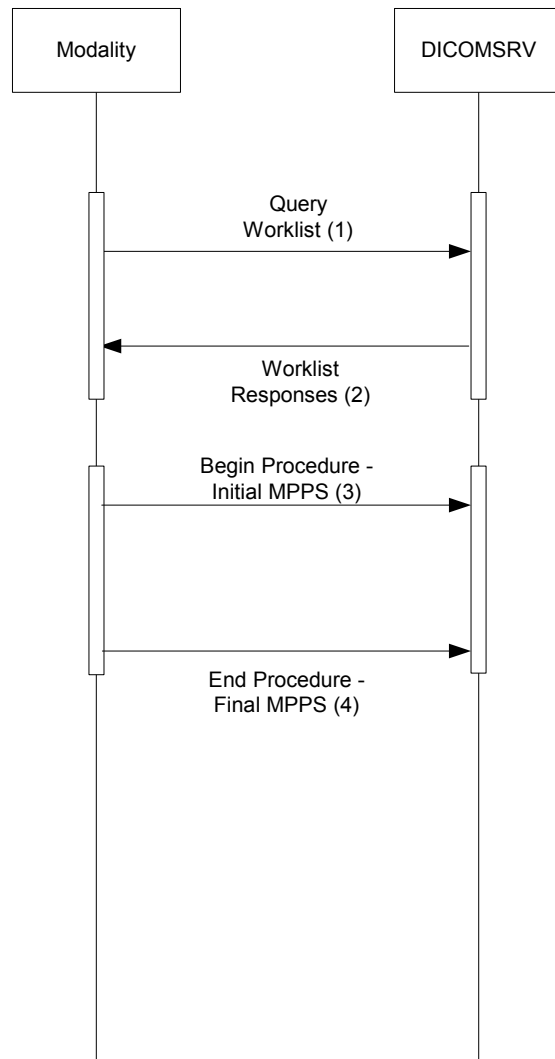
DICOMSRV is a background process running on a Unix server. A single instance of DICOMSRV is started at System boot but multiple instances may be running at any one time as a result of forking of additional processes. The application may be started/restarted interactively via a utility. In addition, there is a monitoring process that may be configured to restart the application automatically should it crash. Events are logged to application-specific log files with a time stamp. Multiple logging levels are supported. At the lowest logging level the following are logged:

- The AE Title of the remote AE when the Association is created
- The status of each DICOM Service Request
- Any updates to the DICOMRIS Database

Higher levels of logging can be configured to cause dumping of the contents of DICOM Service and Association messages..

DICOMSRV will listen for connection requests at the Presentation Address configured for its AE Title. This application is an implementation of a concurrent server; it forks a new process for each connection request it receives. Each forked process exists for the life of a single association and then exits. DICOMSRV will accept Presentation Contexts for the Modality Worklist , Modality Performed Procedure Step and Verification SOP Classes. Validation of DICOM Service Request messages is configurable using command-line parameters and may return Failure status in the event of an invalid Service Request according to the specifications in the standard. Upon receipt of a Verification Request DICOMSRV will respond with a successful Verification response. When a MWL query is received DICOMSRV will query the DICOMRIS database for a list of Scheduled Procedure Steps matching the query and will return a pending C-Find response for each match. Before DICOMRIS can include patient and order information in response to a Modality Worklist query, patients must be registered and there must be orders for those patients in the DICOMRIS database.. Registration and order information is typically interfaced to DICOMRIS from a HIS but can also be entered directly into DICOMRIS using DICOMRIS's registration and order entry applications. Reception of an MPPS N-Create or N-Set Request may result in updates to various tables in the DICOMRIS database and may result in changes to the procedure state of the Requested Procedure(s) referenced within the message. If an MPPS message containing non-matching demographic data is received, this will be logged, an exception document generated and an entry added to an exception table in the database.

#### **C.4.1.3 Sequencing of Real World Activities**



**Figure C.4.1.-2**  
**SEQUENCING CONSTRAINTS**

Under normal circumstances the sequencing depicted above applies:

1. The Modality queries for a worklist of Scheduled Procedure Steps
2. DICOMSRV searches its database and returns matches to the query
3. The Modality begins performance of a Procedure Step and sends the MPPS N-CREATE
4. The Modality completes or discontinues the procedure and sends the MPPS N-SET with status of COMPLETED or DISCONTINUED

The workflow above is not the only one possible. For example, in a Trauma or unscheduled flow there may be no worklist query prior to the performance of the procedure and the sending of MPPS messages. The flow would also be altered if the Modality did not support both Modality Worklist and MPPS. The

Description and Sequencing of Activities and the SOP Specific Conformance sections below for the respective Real World Activities provide additional detail

**C.4.2 AE SPECIFICATIONS**

**C.4.2.1 DICOMSRV AE Specification**

This application provides Standard Conformance to the following DICOM V3.0 SOP Classes:

**C.4.2.1.1 SOP Classes**

**Table C.4.2-1  
SOP CLASSES FOR AE DICOMSRV**

| SOP Class Name                    | SOP Class UID           | SCU | SCP |
|-----------------------------------|-------------------------|-----|-----|
| Verification                      | 1.2.840.10008.1.1       | No  | Yes |
| Modality Worklist                 | 1.2.840.10008.5.1.4.31  | No  | Yes |
| Modality Performed Procedure Step | 1.2.840.10008.3.1.2.3.3 | No  | Yes |

**C.4.2.1.2 Association Policies**

**C.4.2.1.2.1 General**

The Application Context Name for DICOM 3.0 is the only Application Context proposed.

**Table C.4.2-2  
DICOM APPLICATION CONTEXT**

|                          |                       |
|--------------------------|-----------------------|
| Application Context Name | 1.2.840.10008.3.1.1.1 |
|--------------------------|-----------------------|

**C.4.2.1.2.2 Number of Associations**

DICOMSRV will support as many simultaneous associations as SCP as are requested by Workflow SCUs up to a configurable maximum. DICOMSRV limits the number of concurrent associations to a given Workflow SCU as described below.

**Table C.4.2-3  
NUMBER OF ASSOCIATIONS AS AN SCP FOR AE DICOMSRV**

|                                             |                                                                                    |
|---------------------------------------------|------------------------------------------------------------------------------------|
| Maximum number of simultaneous associations | Configurable value.<br>Maximum of 3<br>simultaneous associations<br>to a given SCU |
|---------------------------------------------|------------------------------------------------------------------------------------|

**C.4.2.1.2.3 Asynchronous Nature**

Asynchronous communication (multiple outstanding transactions over a single association) is not supported.

**C.4.2.1.2.4 Implementation Identifying Information**

**Table C.4.2-4  
DICOM IMPLEMENTATION CLASS AND VERSION FOR DICOMSRV**

|                             |                            |
|-----------------------------|----------------------------|
| Implementation Class UID    | xxxxxxx.yyy.etc.ad.inf.usw |
| Implementation Version Name | DICOMRis_260               |

**C.4.2.1.3 Association Initiation Policy**

DICOMSRV does not initiate Associations.

**C.4.2.1.4 Association Acceptance Policy**

DICOMSRV will accept associations for the MWL, MPPS and Verification SOP Classes as an SCP. The job runs in the background and forks a new process for each connection request from a Remote AE

**C.4.2.1.4.1 Activity - Configured AE Requests MWL Query**

**C.4.2.1.4.1.1 Description and Sequencing of Activities**

When Modality Worklist SCUs query DICOMSRV the queries run against the Scheduled Procedure Step Worklist (referred to hereafter as the 'SPS Worklist' or 'Worklist') in the DICOMRis database. There is a configurable mapping between the Universal Service ID contained in the HL7 Order messages (See Table in section C.8.3-1) and one or more Requested Procedures within the DICOMRis database. A Requested Procedure may, in turn, map to 1 or more Scheduled Procedure Steps though the relation is usually 1-to-1. This mapping is also site-configurable. The relation between Accession Number (0008,0050) and Requested Procedure ID (0040,1001) is 1-to-1 within DICOMRis and these attributes have the same value in all MWL responses. Scheduled Procedure Step entries are added and removed from the Worklist as follows:

- Add Scheduled Procedure Step Entries Normal Pathway - As orders are received from the HIS via HL7 or entered using DICOMRis' Ordering and Scheduling application, additions are made to the SPS Worklist in the DICOMRis database per the mapping specified above.
- Add Scheduled Procedure Step Entries Exception Pathway – Users can interactively create additional Scheduled Procedure Step entries for a given Requested Procedure using the Procedure Update application. It may be necessary to create additional entries under certain conditions such as when it is discovered that a procedure must be redone after having previously been marked as completed. This does not apply to canceled procedures
- Remove Scheduled Procedure Step Entries Normal Pathway – An SPS entry is removed from the SPS Worklist under the following circumstances:
  - As mentioned previously, DICOMRis supports common RIS function to set the state of the procedure as it progresses from being ordered to being resulted and signed. Setting the procedure state may be initiated interactively via the Procedure Update application or as a result of various events. An entry in the SPS Worklist is removed when the Requested Procedure that is the parent of the SPS is set to a configured status. This configuration is system-wide applying equally to all procedures.
  - If configured to change the state of a Requested Procedure on receipt of an MPPS N-CREATE or N-SET referencing the procedure then the change in state may result in removal of SPS entries related to the procedure as described above
- Remove Entries Exception Pathway – When a procedure is canceled all SPS entries related to that procedure are removed from the Worklist.

Remove Entries Maintenance Pathway – SPS entries that are still in the Worklist a configurable time after their scheduled start date/time will be removed by a day-end maintenance job.

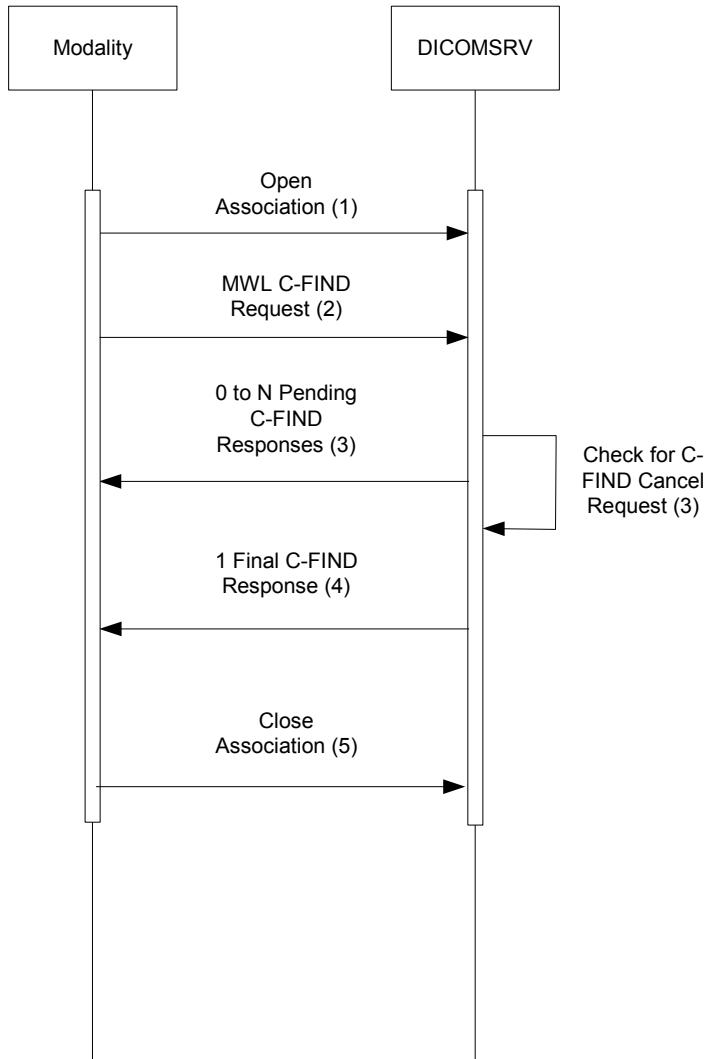
In the table below the following applies:

- To cause a given action to occur, MPPS messages must reference the parent Requested Procedure related to the SPS entry and applicable configuration must be in place.

**Table C.4.2-5  
SCHEDULED PROCEDURE STEP ENTRY ACTIONS TABLE**

| <b>Events</b>                                                                                                                            | <b>Scheduled Procedure Step Entry Actions</b> |
|------------------------------------------------------------------------------------------------------------------------------------------|-----------------------------------------------|
| Order received from HIS or entered using DICOMRis application                                                                            | Add one or more Entries to Worklist           |
| User adds SPS entry interactively                                                                                                        | Add Entry to Worklist                         |
| MPPS message received that changes procedure state of parent procedure to status configured for removal of child SPS entry from Worklist | Remove Entry from Worklist                    |
| Current time exceeds SPS scheduled time by a Worklist configured time interval                                                           | Remove Entry from Worklist                    |
| Parent procedure canceled                                                                                                                | Remove one or more Entries from Worklist      |
| Parent procedure set to a state that causes removal of child SPS entries from Worklist                                                   | Remove one or more Entries from Worklist      |





**Figure C.4.2-1**  
**SEQUENCING DIAGRAM FOR ACTIVITY: CONFIGURED AE REQUESTS MWL QUERY**

The figure above is a possible sequence of messages between a Modality Worklist SCU and DICOMSRV.

1. The Modality opens an Association with DICOMSRV for the purpose of querying for a Modality Worklist
2. The Modality sends an MWL C-FIND query to DICOMSRV
3. DICOMSRV queries its database using the attributes from the C-FIND Request and returns 0 to N C-FIND responses depending on matches returned from the database. DICOMSRV checks for a C-FIND Cancel Request after a configured number of responses are sent. If a Cancel is received then no further Pending responses are sent.
4. DICOMSRV sends the final C-FIND response
5. The Modality closes the Association

**C.4.2.1.4.1.2 Accepted Presentation Contexts**

**Table C.4.2-6  
ACCEPTABLE PRESENTATION CONTEXTS FOR AE DICOMSRV  
AND REAL-WORLD ACTIVITY 'CONFIGURED AE REQUESTS MWL QUERY'**

| Presentation Context Table                 |                        |                                                        |                                          |      |                      |
|--------------------------------------------|------------------------|--------------------------------------------------------|------------------------------------------|------|----------------------|
| Abstract Syntax                            |                        | Transfer Syntax                                        |                                          | Role | Extended Negotiation |
| Name                                       | UID                    | Name List                                              | UID List                                 |      |                      |
| Modality Worklist Information Model – FIND | 1.2.840.10008.5.1.4.31 | Implicit VR Little Endian<br>Explicit VR Little Endian | 1.2.840.10008.1.2<br>1.2.840.10008.1.2.1 | SCP  | None                 |

**C.4.2.1.4.1.2.1 Presentation Context Acceptance Criterion**

Depending on configuration, DICOMSRV may or may not accept multiple Presentation Contexts containing the same Abstract Syntax.

**C.4.2.1.4.1.2.2 Transfer Syntax Selection Policy**

Transfer Syntaxes in addition to the default Implicit VR Little Endian may be configured for a given Abstract Syntax. DICOMSRV's preferred Transfer Syntax is Explicit VR Little Endian and this will be selected if offered.

**C.4.2.1.4.1.3 SOP Specific Conformance for Modality Worklist SOP Class**

DICOMSRV does not support matching on any optional matching key attributes.

DICOMSRV supports case-insensitive matching on the following Person Name Value Representation elements:

Patient Name (0010, 0010)

DICOMSRV supports optional return key attributes as described in the table below.

**Table C.4.2-7  
MODALITY WORKLIST OPTIONAL RETURN KEYS SUPPORTED**

| Description/Module                        | Tag          | Remark                                                                                                                                                                                                                                                                   |
|-------------------------------------------|--------------|--------------------------------------------------------------------------------------------------------------------------------------------------------------------------------------------------------------------------------------------------------------------------|
| <b>Scheduled Procedure Step</b>           |              |                                                                                                                                                                                                                                                                          |
| >Scheduled Protocol Code Sequence         | (0040, 0008) |                                                                                                                                                                                                                                                                          |
| >>Code Meaning                            | (0008, 0104) |                                                                                                                                                                                                                                                                          |
| >Comments on the Scheduled Procedure Step | (0040, 0400) | This attribute, if valued, will contain details of the protocol to be used in carrying out this step. The attribute could contain a full description of the protocol or simply indicate modifications to the protocol designated by the Scheduled Protocol Code Sequence |
| >Requested Contrast Agent                 | (0032, 1070) |                                                                                                                                                                                                                                                                          |

| <b>Requested Procedure</b>                    |              |  |
|-----------------------------------------------|--------------|--|
| Reason for the Requested Procedure            | (0040, 1002) |  |
| Requested Procedure Comments                  | (0040, 1400) |  |
| <b>Imaging Service Request</b>                |              |  |
| Reason for the Imaging Service Request        | (0040,2001)  |  |
| Imaging Service Request Comments              | (0040,2400)  |  |
| Requesting Service                            | (0032,1033)  |  |
| Issuing Date of Imaging Service Request       | (0040,2004)  |  |
| Issuing Time of Imaging Service Request       | (0040,2005)  |  |
| Placer Order Number / Imaging Service Request | (0040,2016)  |  |
| Filler Order Number / Imaging Service Request | (0040,2017)  |  |
| Order entered by                              | (0040,2008)  |  |
| Order Enterer's Location                      | (0040,2009)  |  |
| <b>Visit Status</b>                           |              |  |
| Patient's Institution Residence               | (0038,0400)  |  |
| <b>Visit Admission</b>                        |              |  |
| Referring Physician's                         | (0008,0090)  |  |
| Referring Physician's Address                 | (0008,0092)  |  |
| Referring Physician's Phone Numbers           | (0008,0094)  |  |
| Admitting Diagnosis Description               | (0008,1080)  |  |
| Admitting Date                                | (0038,0020)  |  |
| Admitting Time                                | (0038,0021)  |  |
| <b>Patient Identification</b>                 |              |  |
| Issuer of Patient ID                          | (0010,0021)  |  |
| <b>Patient Demographic</b>                    |              |  |
| Occupation                                    | (0010,2180)  |  |
| Patient's Address                             | (0010,1040)  |  |
| Country of Residence                          | (0010,2150)  |  |
| Patient's Telephone Numbers                   | (0010,2154)  |  |
| Ethnic Group                                  | (0010,2160)  |  |
| Patient's Religious Preference                | (0010,21F0)  |  |
| Patient Comments                              | (0010,4000)  |  |
| <b>Patient Medical</b>                        |              |  |
| Smoking Status                                | (0010,21A0)  |  |
| Last Menstrual Date                           | (0010,21D0)  |  |

DICOMSRV returns C-FIND response statuses as specified below.

**Table C.4.2-8  
MWL C-FIND RESPONSE STATUS REASONS**

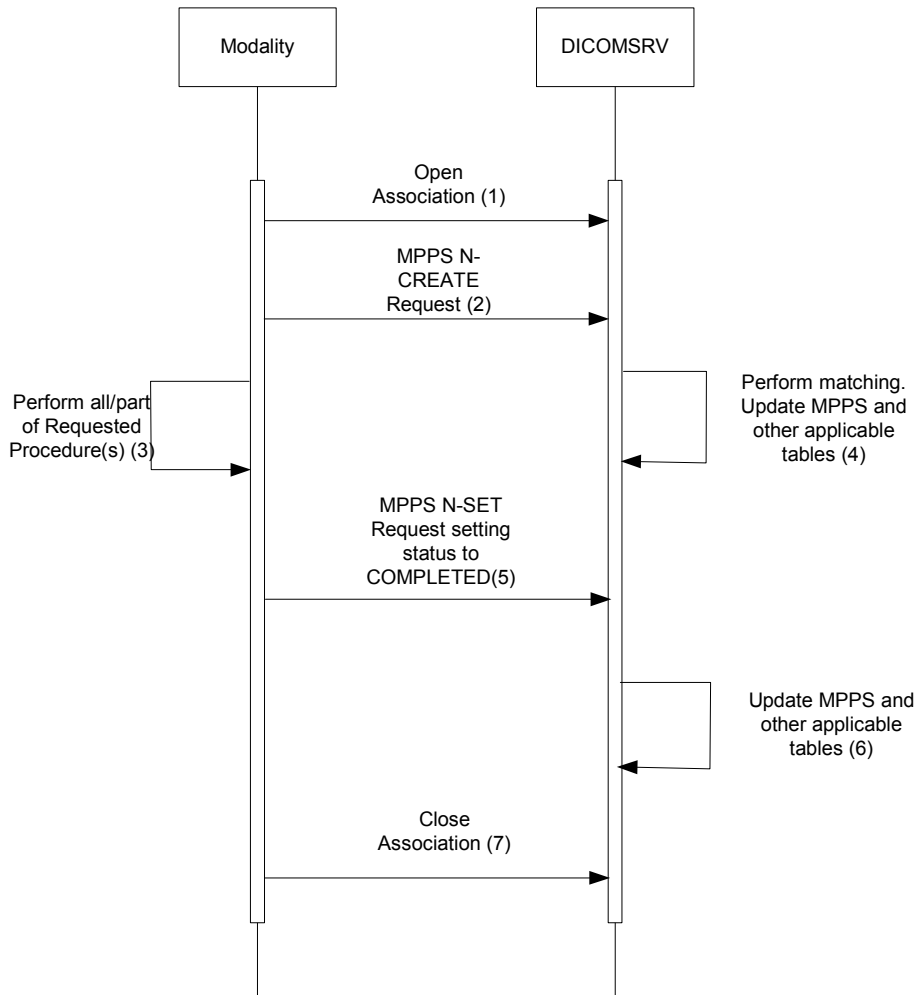
| <b>Service Status</b> | <b>Further Meaning</b>                                                                                                      | <b>Error Code</b> | <b>Reasons</b>                                                                                                                                                                                                                                |
|-----------------------|-----------------------------------------------------------------------------------------------------------------------------|-------------------|-----------------------------------------------------------------------------------------------------------------------------------------------------------------------------------------------------------------------------------------------|
| Success               | Matching is complete                                                                                                        | 0000              | The response status code and meaning are logged in the job log file.                                                                                                                                                                          |
| Failure               | Out of resources                                                                                                            | A700              | If the number of matches exceeds a configurable maximum this error code is returned. An error comment describing the error is also returned. The response status code and meaning are logged in the job log file.                             |
|                       | Identifier does not match SOP class                                                                                         | A900              | This status is returned if the C-FIND request specifies query or Return keys that are not specified as part of the Modality Worklist Information Model – FIND SOP Class. The response status code and meaning are logged in the job log file. |
|                       | Unable to process                                                                                                           | C001              | This status is returned due to internal errors within DICOMSRV such as a processing failure response on a query of the DICOMRIS database. The response status code and meaning are logged in the job log file.                                |
| Canceled              | Matching terminated due to cancel request                                                                                   | FE00              | This status is returned if a Cancel Request is received from the SCU during the processing of a Modality Worklist request. The response status code and meaning are logged in the job log file.                                               |
| Pending               | Matching is continuing                                                                                                      | FF00              | The status is returned with each matching response. A message is logged for each pending response.                                                                                                                                            |
|                       | Matching is continuing – Current match is supplied and any optional keys were supported in the same matter as required keys | FF01              | The status is returned with each matching response if one or more optional matching or return keys are not supported for existence. A message is logged for each pending response.                                                            |

**C.4.2.1.4.2 Activity - Configured AE Makes Procedure Step Request**

When a configured remote AE sends a conformant association request including one of the Modality Performed Procedure Step Presentation Contexts in the table below then DICOMSRV will accept the Association.

**C.4.2.1.4.2.1 Description and Sequencing of Activities**

As mentioned above, DICOMSRV is started at system boot time and is thus ready to process MPPS messages at any time thereafter. The sequencing diagram below specifies a common flow of messages related to this activity. Prior to this sequence of messages it is necessary that orders have been received from the HIS interface or created via DICOMRIS Ordering and Scheduling application. Attributes from the orders and created procedures, usually queried using MWL, will be included in the MPPS messages the Modality sends to DICOMSRV. Key attributes in the MPPS N-CREATE and N-SET, specified below, are extracted and matched against values in the DICOMRIS database. A match allows full update of all applicable DICOMRIS database tables.



**Figure C.4.2-2**  
**SEQUENCING DIAGRAM FOR ACTIVITY: CONFIGURED AE MAKES PROCEDURE STEP REQUEST**

The figure above is a possible sequence of messages and events for the Configured AE Makes Procedure Step Request activity.

1. The Modality opens an Association to update DICOMSRV using MPPS
2. The Modality sends an N-CREATE Request to indicate that it is performing one or more Requested Procedures
3. The Modality performs all or part of the procedure(s)
4. DICOMSRV stores the MPPS and executes the matching algorithm described in the conformance section below. If a successful match is found, then updates to various tables per the N-CREATE are performed. See Table C.4.2-10 for additional detail. In the matching case, the procedure state of the procedure(s) referenced in the MPPS is updated if so configured
5. The Modality sends an N-SET setting the status of the MPPS to COMPLETED

6. DICOMSRV stores the MPPS. If the N-CREATE for this step matched then updates are performed as specified in step 4
7. The Modality closes the Association

DICOMSRV also supports the 5 IHE Unidentified Patient Use Cases. Cases 1, 2 and 4 are transparent to the MPPS SCU and follow the normal flow. In case 3, the patient upon whom a given procedure must be immediately performed has been registered on the HIS and has a valid Patient ID but has no order specifying the applicable procedure. DICOMSRV recognizes this case when an MPPS N-CREATE is received with a matching Patient ID, zero-length Accession Number (0008,0050) and Requested Procedure ID (0040,1001). If the MPPS SCU is configured for support of IHE Trauma cases, DICOMSRV will order a procedure corresponding to the code contained in the Procedure Code Sequence (0008,1032), if this code is recognized, or will order a default procedure based on configuration. If the default procedure is ordered then a user may modify the procedure using DICOMRIS Ordering and Scheduling application.

In case 5, there is no existing registration or order for a patient on whom a procedure must be immediately performed. Values are entered on the Modality identifying the patient and procedure. DICOMSRV recognizes this case when an MPPS N-CREATE is received containing a Patient ID within a configured range. This range will never contain Patient IDs created in the normal flow. If the MPPS SCU is configured for support of IHE Trauma cases, DICOMSRV will register the patient with the Patient ID provided and will order a procedure as described above.

**C.4.2.1.4.2.2 Accepted Presentation Contexts**

**Table C.4.2-9  
ACCEPTABLE PRESENTATION CONTEXTS FOR AE DICOMSRV  
AND REAL-WORLD ACTIVITY “CONFIGURED AE MAKES PROCEDURE STEP REQUEST”**

| Presentation Context Table                  |                         |                                                        |                                          |      |                      |
|---------------------------------------------|-------------------------|--------------------------------------------------------|------------------------------------------|------|----------------------|
| Abstract Syntax                             |                         | Transfer Syntax                                        |                                          | Role | Extended Negotiation |
| Name                                        | UID                     | Name List                                              | UID List                                 |      |                      |
| Modality Performed Procedure Step SOP Class | 1.2.840.10008.3.1.2.3.3 | Implicit VR Little Endian<br>Explicit VR Little Endian | 1.2.840.10008.1.2<br>1.2.840.10008.1.2.1 | SCP  | None                 |

DICOMSRV's preferred Transfer Syntax is Explicit VR Little Endian and this will be selected if offered.

**C.4.2.1.4.2.3 SOP specific Conformance for MPPS SOP Class**

The table below lists all Modality Performed Procedure Step attributes, whether they may be created by N-CREATE and updated by N-SET and what parts of the DICOMRIS database they are used to update. All MPPS messages and thus their attributes are stored for the configurable Purge Period described below. The 'Database Updates' column considers updates separate from the storage of MPPS messages. If no value is present this indicates that there are is no update to the database associated with the given element.

**Table C.4.2-10  
SUPPORTED N-SET/N-CREATE ATTRIBUTES FOR MPPS**

| Attribute Name           | Tag         | N-Create | N-Set | Database Updates |
|--------------------------|-------------|----------|-------|------------------|
| <b>SOP Common Module</b> |             |          |       |                  |
| Specific Character Set   | (0008,0005) | Y        | N     |                  |

| <b>Performed Procedure Step Relationship Module</b> |             |   |   |                                                           |
|-----------------------------------------------------|-------------|---|---|-----------------------------------------------------------|
| Scheduled Step Attribute Sequence                   | (0040,0270) | Y | N | Y                                                         |
| >Study Instance UID                                 | (0020,000D) | Y | N | Overwrite existing value if different from received value |
| >Referenced Study Sequence                          | (0008,1110) | Y | N |                                                           |
| >>Referenced SOP Class UID                          | (0008,1150) | Y | N |                                                           |
| >>Referenced SOP Instance UID                       | (0008,1155) | Y | N |                                                           |
| >Accession Number                                   | (0008,0050) | Y | N |                                                           |
| >Placer Order Number/Imaging Service Request        | (0040,2006) | Y | N |                                                           |
| >Filler Order Number/Imaging Service Request        | (0040,2007) | Y | N |                                                           |
| >Requested Procedure ID                             | (0040,1001) | Y | N |                                                           |
| >Requested Procedure Description                    | (0032,1060) | Y | N |                                                           |
| >Scheduled Procedure Step ID                        | (0040,0009) | Y | N |                                                           |
| >Scheduled Procedure Step Description               | (0040,0007) | Y | N |                                                           |
| >Scheduled Protocol Code Sequence                   | (0040,0008) | Y | N |                                                           |
| >>Code Value                                        | (0008,0100) | Y | N |                                                           |
| >>Coding Scheme designator                          | (0008,0102) | Y | N |                                                           |
| >>Code Meaning                                      | (0008,0104) | Y | N |                                                           |
| Patient Name                                        | (0010,0010) | Y | N |                                                           |
| Patient ID                                          | (0010,0020) | Y | N |                                                           |
| Patient's Birth Date                                | (0010,0030) | Y | N |                                                           |
| Patient's Sex                                       | (0010,0040) | Y | N |                                                           |
| Referenced Patient Sequence                         | (0008,1120) | Y | N |                                                           |
| >Referenced SOP Class UID                           | (0008,1150) | Y | N |                                                           |
| >Referenced SOP Instance UID                        | (0008,1155) | Y | N |                                                           |
| <b>Performed Procedure Step Information</b>         |             |   |   |                                                           |
| Performed Procedure Step ID                         | (0040,0253) | Y | N |                                                           |
| Performed Station AE Title                          | (0040,0241) | Y | N |                                                           |
| Performed Station Name                              | (0040,0242) | Y | N |                                                           |
| Performed Location                                  | (0040,0243) | Y | N |                                                           |
| Performed Procedure Step Start Date                 | (0040,0244) | Y | N |                                                           |
| Performed Procedure Step Start Time                 | (0040,0245) | Y | N |                                                           |
| Performed Procedure Step Status                     | (0040,0252) | Y | Y |                                                           |

|                                              |              |   |   |                                                                                                                                                            |
|----------------------------------------------|--------------|---|---|------------------------------------------------------------------------------------------------------------------------------------------------------------|
| Performed Procedure Step Description         | (0040,0254)  | Y | Y |                                                                                                                                                            |
| Performed Procedure Type Description         | (0040,0255)  | Y | Y |                                                                                                                                                            |
| Procedure Code Sequence                      | (0008,1032)  | Y | Y |                                                                                                                                                            |
| >Code Value                                  | (0008,0100)  | Y | Y |                                                                                                                                                            |
| >Coding Scheme Designator                    | (0008,0102)  | Y | Y |                                                                                                                                                            |
| >Code Meaning                                | (0008,0104)  | Y | Y |                                                                                                                                                            |
| Performed Procedure Step End Date            | (0040,0250)  | Y | Y |                                                                                                                                                            |
| Performed Procedure Step End Time            | (0040,0251)  | Y | Y |                                                                                                                                                            |
| Comments on the Performed Procedure Step     | (0040, 0280) | Y | Y |                                                                                                                                                            |
| <b>Image Acquisition Results</b>             |              |   |   |                                                                                                                                                            |
| Modality                                     | (0008,0060)  | Y | N |                                                                                                                                                            |
| Study ID                                     | (0020,0010)  | Y | N |                                                                                                                                                            |
| Performed Protocol Code Sequence             | (0040,0260)  | Y | Y | If valued, stored with current and historical procedure records                                                                                            |
| >Code Value                                  | (0008,0100)  | Y | Y |                                                                                                                                                            |
| >Coding Scheme Designator                    | (0008,0102)  | Y | Y |                                                                                                                                                            |
| >Code Meaning                                | (0008,0104)  | Y | Y |                                                                                                                                                            |
| Performed Series Sequence                    | (0040,0340)  | Y | Y | Y                                                                                                                                                          |
| >Performing Physician's Name                 | (0008,1050)  | Y | Y | Y                                                                                                                                                          |
| >Protocol Name                               | (0018,1030)  | Y | Y | Stored with current and historical tables                                                                                                                  |
| >Operator's Name                             | (0008,1070)  | Y | Y | If automatic setting of procedure states is enabled, stored in current and historical procedure tables to indicate who modified the state of the procedure |
| >Series Instance UID                         | (0020,000E)  | Y | Y |                                                                                                                                                            |
| >Series Description                          | (0008,103E)  | Y | Y |                                                                                                                                                            |
| >Retrieve AE Title                           | (0008,0054)  | Y | Y |                                                                                                                                                            |
| Referenced Image Sequence                    | (0008,1140)  | Y | Y |                                                                                                                                                            |
| >>Referenced SOP Class UID                   | (0008,1150)  | Y | Y |                                                                                                                                                            |
| >>Referenced SOP Instance UID                | (0008,1155)  | Y | Y |                                                                                                                                                            |
| >Referenced Standalone SOP Instance Sequence | (0040,0220)  | Y | Y |                                                                                                                                                            |
| >>Referenced SOP Class UID                   | (0008,1150)  | Y | Y |                                                                                                                                                            |
| >>Referenced SOP Instance UID                | (0008,1155)  | Y | Y |                                                                                                                                                            |
| <b>Radiation Dose</b>                        |              |   |   |                                                                                                                                                            |
| Anatomic Structure, Space or Region Sequence | (0008,2229)  |   |   |                                                                                                                                                            |
| >Code Value                                  | (0008,0100)  | Y | Y |                                                                                                                                                            |
| >Coding Scheme Designator                    | (0008,0102)  | Y | Y |                                                                                                                                                            |
| >Code Meaning                                | (0008,0104)  | Y | Y |                                                                                                                                                            |



|                                             |             |   |   |                                                                                                                                                |
|---------------------------------------------|-------------|---|---|------------------------------------------------------------------------------------------------------------------------------------------------|
| Total Time of Fluoroscopy                   | (0040,0300) | Y | Y | Stored in Procedure Techniques table                                                                                                           |
| Total Number of Exposures                   | (0040,0301) | Y | Y | Stored in Procedure Techniques table                                                                                                           |
| Distance Source to Detector                 | (0018,1110) | Y | Y | Stored in Procedure Techniques table                                                                                                           |
| Distance Source to Entrance                 | (0040,0306) | Y | Y | Stored in Procedure Techniques table                                                                                                           |
| Entrance Dose                               | (0040,0302) | Y | Y | Stored in Procedure Techniques table                                                                                                           |
| Entrance Dose in mGy                        | (0040,8302) | Y | Y |                                                                                                                                                |
| Exposed Area                                | (0040,0303) | Y | Y | Stored in Procedure Techniques table                                                                                                           |
| Image Area Dose Product                     | (0018,115E) | Y | Y | Stored in Procedure Techniques table                                                                                                           |
| Comments on Radiation Dose                  | (0040,0310) | Y | Y |                                                                                                                                                |
| <b>Billing and Material Management Code</b> |             |   |   |                                                                                                                                                |
| Billing Procedure Step Sequence             |             |   |   |                                                                                                                                                |
| >Code Value                                 | (0008,0100) | Y | Y |                                                                                                                                                |
| >Coding Scheme Designator                   | (0008,0102) | Y | Y |                                                                                                                                                |
| >Code Meaning                               | (0008,0104) | Y | Y |                                                                                                                                                |
| Film Consumption Sequence                   | (0040,0321) | Y | Y |                                                                                                                                                |
| > Number of Films                           | (2100,0170) | Y | Y | Updates Supply and Film-Procedure Tables                                                                                                       |
| > Medium Type                               | (2000,0030) | Y | Y |                                                                                                                                                |
| > Film Size ID                              | (2010,0050) | Y | Y |                                                                                                                                                |
| Billing Supplies and Devices Sequence       | (0040,0384) | Y | Y |                                                                                                                                                |
| >Billing Item Sequence                      | (0040,0296) | Y | Y |                                                                                                                                                |
| >>Code Value                                | (0008,0100) | Y | Y | Updates Supply table if Coding Scheme Designator for Billing Item Sequence is DICOMRIS_SUPPLY and the Code Value is a value from this Code Set |
| >>Coding Scheme Designator                  | (0008,0102) | Y | Y |                                                                                                                                                |
| >>Code Meaning                              | (0008,0104) | Y | Y |                                                                                                                                                |
| >Quantity Sequence                          | (0040,0293) | Y | Y |                                                                                                                                                |
| >>Quantity                                  | (0040,0294) | Y | Y |                                                                                                                                                |
| >>Measuring Units Sequence                  | (0040,0295) | Y | Y |                                                                                                                                                |
| >>>Code Value                               | (0008,0100) | Y | Y |                                                                                                                                                |
| >>>Coding Scheme Designator                 | (0008,0102) | Y | Y |                                                                                                                                                |
| >>>Code Meaning                             | (0008,0104) | Y | Y |                                                                                                                                                |

The list below details the behavior of DICOMSRV on occurrence of certain MPPS events and with respect to the coercion of attributes and duration of storage of MPPS messages:

- Reception of a New MPPS Instance – The MPPS message is stored in the database. DICOMSRV will then extract the Patient ID (0020, 0010) and as many Accession Numbers (0008, 0050) as there are items in the Scheduled Step Attribute Sequence (0040,0270) from the N-CREATE and try to match these values against the Patient Medical Record Number and one or more Accession

Numbers in the DICOMRis database. If a non-matching N-CREATE is received, it and any following N-SETs will be marked as exceptions. These exceptions can be reconciled using the RisView application. Otherwise, DICOMSRV will:

- Update its database with values contained in the N-CREATE per table above.
- Update the state of each referenced procedure if so configured.
- Update of MPPS to 'DISCONTINUED' or 'COMPLETED' – The N-SET is stored in the database. If the preceding N-CREATE matched then the following is done:
  - The attribute values in the N-SET will be used to update the DICOMRis database per table above.
  - Update the state of each referenced procedure if so configured.
- Coercion of Attributes – DICOMSRV will coerce attributes as specified in Table C.8.1-3. This coercion may occur when a given step is set to the 'IN PROGRESS' or 'COMPLETED' or 'DISCONTINUED'
- Storage Duration for MPPS Messages – MPPS messages are purged from the DICOMRis database after a configurable period of time has elapsed since the step has been set to a final state or was last updated.

**Table C.4.2-11  
MPPS N-CREATE/N-SET RESPONSE STATUS REASONS**

| <b>Service Status</b> | <b>Further Meaning</b>                                 | <b>Error Code</b> | <b>Reasons</b>                                                                                                                                                                                                                     |
|-----------------------|--------------------------------------------------------|-------------------|------------------------------------------------------------------------------------------------------------------------------------------------------------------------------------------------------------------------------------|
| Success               | Successful completion of the N-SET or N-CREATE Request | 0000              | The response status code and meaning are logged in the job log file.                                                                                                                                                               |
| Failure               | Processing Failure                                     | 0110              | Internal error within DICOMSRV. The response status code and meaning are logged in the job log file.                                                                                                                               |
|                       | Duplicate SOP Instance                                 | 0111              | This status is returned when the SCU has attempted to N-CREATE a SOP Instance that has already been created. The response status code and meaning are logged in the job log file                                                   |
|                       | No such SOP Instance                                   | 0112              | Status returned when the SCU is trying to SET a SOP instance which has not been created. The response status code and meaning are logged in the job log file                                                                       |
|                       | Missing Attribute                                      | 0120              | This status is returned if an attribute required to be sent in the N-CREATE or required to be sent before completion of the Procedure Step has not been sent. The response status code and meaning are logged in the job log file. |

**C.4.2.1.4.3 Activity - Configured AE Requests Verification**

**C.4.2.1.4.3.1 Description and Sequencing of Activities**

A remote AE sends an Echo Request to verify that DICOMSRV is awake and listening. DICOMSRV responds with success status as long as the request can be parsed.

**C.4.2.1.4.3.2 Accepted Presentation Contexts**

**Table C.4.2-12  
ACCEPTABLE PRESENTATION CONTEXTS FOR AE DICOMSRV AND  
REAL-WORLD ACTIVITY CONFIGURED AE REQUESTS VERIFICATION**

| <b>Presentation Context Table</b> |                   |                                                        |                                          |             |                             |
|-----------------------------------|-------------------|--------------------------------------------------------|------------------------------------------|-------------|-----------------------------|
| <b>Abstract Syntax</b>            |                   | <b>Transfer Syntax</b>                                 |                                          | <b>Role</b> | <b>Extended Negotiation</b> |
| <b>Name</b>                       | <b>UID</b>        | <b>Name List</b>                                       | <b>UID List</b>                          |             |                             |
| Verification SOP Class            | 1.2.840.10008.1.1 | Implicit VR Little Endian<br>Explicit VR Little Endian | 1.2.840.10008.1.2<br>1.2.840.10008.1.2.1 | SCP         | None                        |

**C.4.2.1.4.3.3 SOP Specific Conformance**

DICOMSRV provides Standard conformance to the DICOM Verification service class.

**C.4.2.1.4.3.4 Presentation Context Acceptance criterion**

Depending on configuration, DICOMSRV may or may not accept multiple presentation contexts containing the same abstract syntax.

**C.4.2.1.4.3.5 Transfer Syntax Selection Policy**

Transfer Syntaxes in addition to the default Implicit VR Little Endian may be configured for a given Abstract Syntax using DICOM Tool's configuration files. When this is done, the first Transfer Syntax encountered in the configuration file, which matches a Transfer Syntax offered for a given Presentation Context, will be selected as the accepted Transfer Syntax for that Presentation Context.

**C.4.3 NETWORK INTERFACES**

**C.4.3.1 Physical Network Interface**

The DICOMRis DICOM applications are indifferent to the physical medium over which TCP/IP executes.

**C.4.3.2 Additional Protocols**

DHCP support can be configured using the Configuration application. If DHCP is not configured a static IP address is assigned.

If DNS support exists on the local network, then DNS is used for address resolution. The address of the DNS server is retrieved using DHCP if the DHCP option is enabled. If DNS is not supported then the hostnames and addresses are configured in the local hosts file.

**C.4.3.3 IPv4 and IPv6 Support**

This product supports both IPv4 and IPv6. It does not utilize any of the optional configuration identification or security features of IPv6.

**C.4.4 CONFIGURATION**

**C.4.4.1 AE Title/Presentation Address Mapping**

The AE Title and port of DICOMSRV is configurable by the user from a GUI-based configuration application. The IP Address is picked by the site and may be changed by a Field Engineer.

**C.4.4.1.1 Local AE Titles**

**Table C.4.2-13  
AE TITLE CONFIGURATION TABLE**

| Application Entity | Default AE Title   | Default TCP/IP Port |
|--------------------|--------------------|---------------------|
| DICOMSRV           | Must be configured | 104                 |

#### C.4.4.1.2 Remote AE Title/Presentation Address Mapping

The AE Titles, host names, port numbers and supported Presentation Contexts of remote applications are configured in file DICOMSRV.cfg. This file is referenced by DICOMTool's software when API calls are made to create Associations to remote AEs

#### C.4.4.2 Parameters

DICOMSRV configuration parameters related to DICOM communications are below. A blank cell under the 'Default Value' heading indicates that there is no default value for the specific configuration attribute.

**Table C.4.2-14  
CONFIGURATION PARAMETERS TABLE**

| Parameter                                                                            | Configurable | Default Value                                                                                                   |
|--------------------------------------------------------------------------------------|--------------|-----------------------------------------------------------------------------------------------------------------|
| <b>General Parameters</b>                                                            |              |                                                                                                                 |
| Time-out waiting for acceptance or rejection Response to an Association Open Request | Yes          | 30 Seconds                                                                                                      |
| Time-out waiting for response to TCP/IP connect() request.                           | Yes          | 15 Seconds                                                                                                      |
| Time-out for waiting for data between TCP/IP packets. (Low-level timeout)            | Yes          | 15 Seconds                                                                                                      |
| Time-out waiting for a response to a DIMSE Request                                   | Yes          | 30 Seconds                                                                                                      |
| Time-out waiting for the next DIMSE Request                                          | Yes          | 60 Seconds                                                                                                      |
| <b>Debugging Capabilities</b>                                                        |              |                                                                                                                 |
| Hex Dump DIMSE Messages                                                              | Yes          | Off                                                                                                             |
| Hex Dump Association Messages                                                        | Yes          | Off                                                                                                             |
| <b>Tcp/Ip Settings</b>                                                               |              |                                                                                                                 |
| Tcp/Ip Send Buffer                                                                   | Yes          | 65535 Bytes                                                                                                     |
| <b>TCP//IP Receive Buffer</b>                                                        | <b>Yes</b>   | <b>65535 Bytes</b>                                                                                              |
| PacketFilter                                                                         | Yes          | On. This option enables running of tcpdump utility from the command line to capture tcp packet headers/contents |
| <b>DICOMSRV Parameters</b>                                                           |              |                                                                                                                 |
| Maximum Number of Simultaneous Associations                                          | Yes          | 20                                                                                                              |
| Maximum Number of Associations to a given device                                     | Yes          | 3                                                                                                               |
| Maximum PDU size the AE can receive                                                  | Yes          | 65536 Bytes                                                                                                     |
| Maximum PDU size the AE can send                                                     | No           | The lower of the value above and the max PDU size specified by the Remote AE in the Association Request         |
| Validation of DICOM Service Messages                                                 | Yes          | Validate messages                                                                                               |

| Parameter                                                                                         | Configurable | Default Value                                                                          |
|---------------------------------------------------------------------------------------------------|--------------|----------------------------------------------------------------------------------------|
|                                                                                                   |              | and log validation errors. Do not automatically return error for all validation errors |
| <b>Modality Worklist Parameters</b>                                                               |              |                                                                                        |
| Maximum Number of Matches for an MWL Request                                                      | Yes          | 100                                                                                    |
| Time period after Scheduled Date/Time to leave SPS entries in the SPS Worklist                    | Yes          | 2880 min                                                                               |
| State of Parent Procedure that causes deletion of child SPS Entries                               | Yes          | PROCEDURE STARTED                                                                      |
| Supported Transfer Syntaxes                                                                       | Yes          | Explicit VR Little Endian<br>Implicit VR Little Endian                                 |
| <b>Modality Performed Procedure Step Parameters</b>                                               |              |                                                                                        |
| Generate charges based on supplies specified in MPPS transactions                                 | Yes          | Off                                                                                    |
| Purge Period for MPPS transactions in final state                                                 | Yes          | 30 days                                                                                |
| State to automatically set procedures to for a given AE on receipt of matching N-CREATE           | Yes          |                                                                                        |
| State to automatically set procedures to for a given AE on receipt of matching N-SET COMPLETED    | Yes          |                                                                                        |
| State to automatically set procedures to for a given AE on receipt of matching N-SET DISCONTINUED | Yes          |                                                                                        |
| Flag specifying support for IHE Trauma cases for a given AE                                       | Yes          | false                                                                                  |
| Patient ID Range to be used for Patient Registration for IHE Trauma case                          | Yes          |                                                                                        |
| Default Procedure Code to be used for orders for IHE Trauma cases                                 | Yes          |                                                                                        |
| Supported Transfer Syntaxes                                                                       | Yes          | Explicit VR Little Endian<br>Implicit VR Little Endian                                 |

## **C.5 MEDIA INTERCHANGE**

DICOMSRV does not support Media Storage

## C.6 SUPPORT OF CHARACTER SETS

DICOMSRV support the following character sets in addition to the default:

- ISO\_IR 100

## **C.7 SECURITY**

DICOMSRV does not support any specific security measures



## C.8 ANNEXES

### C.8.1 IOD CONTENTS

#### C.8.1.1 Created SOP Instances

DICOMRis does not create SOP instances

#### C.8.1.2 Usage of Attributes from received IOD's

Fields from MPPS such as technique and supplies and how they are used

**Table C.8.1-1  
ATTRIBUTES IN MPPS IOD USED BY DICOMRIS APPLICATIONS**

| Attribute Name                                      | Tag         | Database Updates                                                                                                                                                                                                             |
|-----------------------------------------------------|-------------|------------------------------------------------------------------------------------------------------------------------------------------------------------------------------------------------------------------------------|
| <b>SOP Common Module</b>                            |             |                                                                                                                                                                                                                              |
| <b>Performed Procedure Step Relationship Module</b> |             |                                                                                                                                                                                                                              |
| Scheduled Step Attribute Sequence                   | (0040,0270) |                                                                                                                                                                                                                              |
| >Accession Number                                   | (0008,0050) | These attributes need to match values in the DICOMRis database so other data contained in MPPS messages e.g. Dose and Materials data, can update the database and be displayed by the RisView application as described below |
| Patient ID                                          | (0010,0020) |                                                                                                                                                                                                                              |
| <b>Performed Procedure Step Information</b>         |             |                                                                                                                                                                                                                              |
| Performed Station AE Title                          | (0040,0241) | This attribute is used by the MppsSrv application as a key into the DICOM Configuration database to determine if the procedure referenced by the MPPS message should automatically have its state changed                    |
| Performed Procedure Step Description                | (0040,0254) | Values for these attributes are accessible using the RisView application if they have been stored                                                                                                                            |
| Procedure Code Sequence                             | (0008,1032) |                                                                                                                                                                                                                              |
| >Code Value                                         | (0008,0100) |                                                                                                                                                                                                                              |
| >Coding Scheme Designator                           | (0008,0102) |                                                                                                                                                                                                                              |
| >Code Meaning                                       | (0008,0104) |                                                                                                                                                                                                                              |
| <b>Image Acquisition Results</b>                    |             |                                                                                                                                                                                                                              |
| Performed Protocol Code Sequence                    | (0040,0260) | Values for these attributes are required if the RisView application is to display the protocol used to perform the procedure                                                                                                 |
| >Code Value                                         | (0008,0100) |                                                                                                                                                                                                                              |

|                                             |             |                                                                                                                                                                                                                                       |
|---------------------------------------------|-------------|---------------------------------------------------------------------------------------------------------------------------------------------------------------------------------------------------------------------------------------|
| >Coding Scheme Designator                   | (0008,0102) |                                                                                                                                                                                                                                       |
| >Code Meaning                               | (0008,0104) |                                                                                                                                                                                                                                       |
| Performed Series Sequence                   | (0040,0340) |                                                                                                                                                                                                                                       |
| >Protocol Name                              | (0018,1030) |                                                                                                                                                                                                                                       |
| >Operator's Name                            | (0008,1070) | Can be displayed by RisView application                                                                                                                                                                                               |
| >Retrieve AE Title                          | (0008,0054) |                                                                                                                                                                                                                                       |
| <b>Radiation Dose</b>                       |             |                                                                                                                                                                                                                                       |
| Total Time of Fluoroscopy                   | (0040,0300) | Values are needed for these attributes so that dose exposure data can be displayed by the RisView application                                                                                                                         |
| Total Number of Exposures                   | (0040,0301) |                                                                                                                                                                                                                                       |
| Distance Source to Detector                 | (0018,1110) |                                                                                                                                                                                                                                       |
| Distance Source to Entrance                 | (0040,0306) |                                                                                                                                                                                                                                       |
| Entrance Dose                               | (0040,0302) |                                                                                                                                                                                                                                       |
| Exposed Area                                | (0040,0303) |                                                                                                                                                                                                                                       |
| Image Area Dose Product                     | (0018,115E) |                                                                                                                                                                                                                                       |
| <b>Billing and Material Management Code</b> |             |                                                                                                                                                                                                                                       |
| Billing Procedure Step Sequence             |             | Values are needed for these attributes so that the RisView application can display actual supplies and film used to perform a given procedure rather than default values associated with the given procedure in the DICOMRis database |
| >Code Value                                 | (0008,0100) |                                                                                                                                                                                                                                       |
| >Coding Scheme Designator                   | (0008,0102) |                                                                                                                                                                                                                                       |
| >Code Meaning                               | (0008,0104) |                                                                                                                                                                                                                                       |
| Film Consumption Sequence                   | (0040,0321) | The values of these attributes may also be used to generate charges if the site is configured for charging based on MPPS                                                                                                              |
| > Number of Films                           | (2100,0170) |                                                                                                                                                                                                                                       |
| > Medium Type                               | (2000,0030) |                                                                                                                                                                                                                                       |
| > Film Size ID                              | (2010,0050) |                                                                                                                                                                                                                                       |
| Billing Supplies and Devices Sequence       | (0040,0384) |                                                                                                                                                                                                                                       |
| >Billing Item Sequence                      | (0040,0296) |                                                                                                                                                                                                                                       |
| >>Code Value                                | (0008,0100) |                                                                                                                                                                                                                                       |
| >>Coding Scheme Designator                  | (0008,0102) |                                                                                                                                                                                                                                       |
| >>Code Meaning                              | (0008,0104) |                                                                                                                                                                                                                                       |
| >Quantity Sequence                          | (0040,0293) |                                                                                                                                                                                                                                       |
| >>Quantity                                  | (0040,0294) |                                                                                                                                                                                                                                       |
| >>Measuring Units Sequence                  | (0040,0295) |                                                                                                                                                                                                                                       |
| >>>Code Value                               | (0008,0100) |                                                                                                                                                                                                                                       |
| >>>Coding Scheme Designator                 | (0008,0102) |                                                                                                                                                                                                                                       |
| >>>Code Meaning                             | (0008,0104) |                                                                                                                                                                                                                                       |

### C.8.1.3 Attribute Mapping

The mapping between attributes received via HL7 from the HIS and those supplied in Modality Worklist is configurable. The default mapping is contained in the table below. Empty cells indicate that there is no mapping for the specific attribute

**Table C.8.1-2  
HL7/MODALITY WORKLIST ATTRIBUTE MAPPING**

| DICOM Attribute                           | DICOM Tag    | HL7 Attribute Name | HL7 Segment   | Notes              |
|-------------------------------------------|--------------|--------------------|---------------|--------------------|
| <b>Scheduled Procedure Step</b>           |              |                    |               |                    |
| Scheduled Procedure Step Sequence         | (0040,0100)  |                    |               |                    |
| > Scheduled Station AET                   | (0040,0002)  |                    |               | DICOMRis generated |
| > Scheduled Procedure Step Start Date     | (0040,0003)  | Quantity/Timing    | ORM<br>OBR:27 | DICOMRis generated |
| > Scheduled Procedure Step Start Time     | (0040,0006)  | Quantity/Timing    | ORM<br>OBR:27 | DICOMRis generated |
| > Modality                                | (0008,0060)  |                    |               | DICOMRis generated |
| > Scheduled Performing Physician's Name   | (0040,0006)  | Technician         | ORM<br>OBR:34 |                    |
| > Scheduled Procedure Step Description    | (0040,0007)  |                    |               | DICOMRis generated |
| >Scheduled Station Name                   | (0040,0010)  |                    |               | DICOMRis generated |
| >Scheduled Procedure Step Location        | (0040,0011)  |                    |               | DICOMRis generated |
| >Scheduled Protocol Code Sequence         | (0040, 0008) |                    |               |                    |
| >>Code Value                              | (0008, 0100) |                    |               | DICOMRis generated |
| >>Coding Scheme Designator                | (0008, 0102) |                    |               | DICOMRis generated |
| >>Code Meaning                            | (0008, 0104) |                    |               | DICOMRis generated |
| > Pre-Medication                          | (0040,0012)  |                    |               | DICOMRis generated |
| > Scheduled Procedure Step ID             | (0040,0009)  |                    |               | DICOMRis generated |
| > Requested Contrast Agent                | (0032,1070)  |                    |               | DICOMRis generated |
| >Scheduled Procedure Step Status          | (0040,0020)  |                    |               | DICOMRis generated |
| >Comments on the Scheduled Procedure Step | (0040, 0400) |                    |               | DICOMRis generated |

| <b>Requested Procedure</b>             |              |                      |               |                                                                                                                               |
|----------------------------------------|--------------|----------------------|---------------|-------------------------------------------------------------------------------------------------------------------------------|
| Requested Procedure ID                 | (0040,1001)  |                      |               | DICOMRIS generated                                                                                                            |
| Requested Procedure Description        | (0032,1060)  |                      |               | DICOMRIS generated                                                                                                            |
| Requested Procedure Code Sequence      | (0032,1064)  |                      |               |                                                                                                                               |
| >Code Value                            | (0008, 0100) | Universal Service Id | ORM<br>OBR:4  | The value in the HL7 attribute is mapped to one or more procedure codes in the DICOMRIS database. The mapping is configurable |
| >Coding Scheme Designator              | (0008, 0102) | Universal Service Id | ORM<br>OBR:4  | Maps to a site-defined Coding Scheme, the CPT Coding Scheme or the DICOMRIS internal Coding Scheme                            |
| >Code Meaning                          | (0008, 0104) |                      |               | DICOMRIS generated                                                                                                            |
| Study Instance UID                     | (0020,000D)  |                      |               | DICOMRIS generated                                                                                                            |
| Referenced Study Sequence              | (0008,1110)  |                      |               |                                                                                                                               |
| >Referenced SOP Class UID              | (0008,1150)  |                      |               | DICOMRIS generated                                                                                                            |
| >Referenced SOP Instance UID           | (0008,1155)  |                      |               | DICOMRIS generated                                                                                                            |
| Requested Procedure Priority           | (0040,1003)  |                      | ORM<br>OBR:27 |                                                                                                                               |
| Patient Transport Arrangements         | (0040,1004)  |                      | ORM<br>OBR:30 |                                                                                                                               |
| Reason for the Requested Procedure     | (0040, 1002) |                      |               | DICOMRIS generated                                                                                                            |
| <b>Imaging Service Request</b>         |              |                      |               |                                                                                                                               |
| Accession Number                       | (0008,0050)  |                      |               | DICOMRIS generated                                                                                                            |
| Requesting Physician                   | (0032,1032)  |                      | ORM<br>OBR:16 |                                                                                                                               |
| Referring Physician's Name             | (0008,0090)  |                      | ORM<br>PV1:8  |                                                                                                                               |
| Reason for the Imaging Service Request | (0040,2001)  | Reason for Study     | ORM<br>OBR:31 |                                                                                                                               |
| Order Entered By                       | (0040,2008)  | Entered By           | ORM<br>ORC:10 |                                                                                                                               |

|                                   |              |                               |               |  |
|-----------------------------------|--------------|-------------------------------|---------------|--|
| Order Enterer's Location          | (0040,2009)  | Entering Organization         | ORM<br>ORC:17 |  |
| <b>Visit Identification</b>       |              |                               |               |  |
| Admission ID                      | (0038,0010)  |                               | ADT<br>PID:3  |  |
| Admitting Diagnosis Description   | (0008,1080)  |                               | ADT<br>DG1:4  |  |
| Admitting Diagnoses Code Sequence | (0008,1084)  |                               |               |  |
| >Code Value                       | (0008, 0100) |                               | ADT<br>DG1:3  |  |
| >Coding Scheme Designator         | (0008, 0102) |                               | ADT<br>DG1:2  |  |
| >Code Meaning                     | (0008, 0104) |                               |               |  |
| <b>Patient Identification</b>     |              |                               |               |  |
| Patient's Name                    | (0010,0010)  |                               | ADT<br>PID:5  |  |
| Patient ID                        | (0010,0020)  |                               | ADT<br>PID:3  |  |
| <b>Patient Demographics</b>       |              |                               |               |  |
| Patients Birth Date               | (0010,0030)  |                               | ADT<br>PID:7  |  |
| Patient's Sex                     | (0010,0040)  |                               | ADT<br>PID:8  |  |
| Patient's Weight                  | (0010,1030)  |                               | ADT<br>OBX:5  |  |
| Ethnic Group                      | (0010,2160)  |                               | ADT<br>PID:10 |  |
| Patient Comment                   | (0010,4000)  |                               | ORM<br>NTE:3  |  |
| <b>Patient Medical</b>            |              |                               |               |  |
| Patient State                     | (0038,0500)  | Danger Code                   | ORM<br>OBR:12 |  |
| Pregnancy Status                  | (0010,21C0)  | Filler Field 1                | ORM<br>OBR:20 |  |
| Medical Alerts                    | (0010,2000)  | Relevant Clinical Information | ORM<br>OBR:13 |  |
| Allergies                         | (0010,2110)  |                               | ADT<br>AL1:3  |  |
| Last Menstrual Date               | (0010,21D0)  | Filler Field 1                | ORM<br>OBR:20 |  |

**C.8.1.4 Coerced/Modified Fields**

**Table C.8.1-3  
COERCED FIELDS FOR MODALITY PERFORMED PROCEDURE STEP**

- Standard -

| Attribute Name                                      | Tag         | Coercion Conditions                                                                                                                                                                                    |
|-----------------------------------------------------|-------------|--------------------------------------------------------------------------------------------------------------------------------------------------------------------------------------------------------|
| <b>Performed Procedure Step Relationship Module</b> |             |                                                                                                                                                                                                        |
| Scheduled Step Attribute Sequence                   | (0040,0270) |                                                                                                                                                                                                        |
| >Accession Number                                   | (0008,0050) | Procedure Step has been placed in the Exception queue due to failure to match DICOMRIS database. User enters a corrected value for Accession number through the RisView application                    |
| >Placer Order Number/Imaging Service Request        | (0040,2006) | Value for this attribute is coerced when the value does not match the corresponding value in the DICOMRIS database. This may occur when the step is initially processed or during exception resolution |
| >Filler Order Number/Imaging Service Request        | (0040,2007) | As for attribute Placer Order Number/Imaging Service Request                                                                                                                                           |
| >Requested Procedure ID                             | (0040,1001) | As for attribute Placer Order Number/Imaging Service Request                                                                                                                                           |
| >Requested Procedure Description                    | (0032,1060) | As for attribute Placer Order Number/Imaging Service Request                                                                                                                                           |
| >Scheduled Procedure Step ID                        | (0040,0009) | As for attribute Placer Order Number/Imaging Service Request                                                                                                                                           |
| >Scheduled Procedure Step Description               | (0040,0007) | As for attribute Placer Order Number/Imaging Service Request                                                                                                                                           |
| >Scheduled Protocol Code Sequence                   | (0040,0008) | As for attribute Placer Order Number/Imaging Service Request                                                                                                                                           |
| >>Code Value                                        | (0008,0100) | As for attribute Placer Order Number/Imaging Service Request                                                                                                                                           |
| >>Coding Scheme designator                          | (0008,0102) | As for attribute Placer Order Number/Imaging Service Request                                                                                                                                           |
| >>Code Meaning                                      | (0008,0104) | As for attribute Placer Order Number/Imaging Service Request                                                                                                                                           |
| Patient Name                                        | (0010,0010) | As for attribute Placer Order Number/Imaging Service Request                                                                                                                                           |
| Patient ID                                          | (0010,0020) | Procedure Step has been placed in the Exception queue due to failure to match DICOMRIS database. User enters a corrected value for Patient ID through the RisView application                          |
| Patient's Birth Date                                | (0010,0030) | As for attribute Placer Order Number/Imaging Service Request                                                                                                                                           |
| Patient's Sex                                       | (0010,0040) | As for attribute Placer Order Number/Imaging Service Request                                                                                                                                           |

### C.8.2 DATA DICTIONARY OF PRIVATE ATTRIBUTES

DICOMSRV does not use any private attributes.

### C.8.3 CODED TERMINOLOGY AND TEMPLATES

DICOMRIS's usage of Coding Schemes is specified in the table below. This table lists the Coding Schemes used by DICOMRIS for attributes it originates. Usage of Controlled Terminology by Applications sending IODs to DICOMRIS is discussed in the relevant SOP Specific Conformance sections above. The Procedure and Protocol Codes in the DICOMRIS database can be exported to files and transferred across the network using the Configuration Utility. This allows Modalities to access and incorporate these codes if so desired.

**Table C.8.1-4  
DICOMRIS CONTROLLED TERMINOLOGY USAGE**

| SOP Class/Service                      | Attribute Name                    | Tag         | Baseline Context Id | Coding Scheme                                                                            | Remarks                                                                                                                                                                                                                                                                                                                                                                                                                                                                  |
|----------------------------------------|-----------------------------------|-------------|---------------------|------------------------------------------------------------------------------------------|--------------------------------------------------------------------------------------------------------------------------------------------------------------------------------------------------------------------------------------------------------------------------------------------------------------------------------------------------------------------------------------------------------------------------------------------------------------------------|
| <b>Scheduled Procedure Step Module</b> |                                   |             |                     |                                                                                          |                                                                                                                                                                                                                                                                                                                                                                                                                                                                          |
| MWL/ C-FIND                            | >Scheduled Protocol Code Sequence | (0040,0008) | None                | CPT-4, DICOMRIS Procedure, site-supplied procedure codes or site-supplied protocol codes | At the option of the site, DICOMRIS may be configured to associate CPT-4, DICOMRIS Internal codes or site-supplied procedure codes with the various procedures represented in their Item master file. The configured procedure code will be passed in this attribute unless the site has supplied and configured protocol codes to be associated with the respective procedures in addition to procedure codes. In this case the configured protocol code will be passed |
| <b>Requested Procedure Module</b>      |                                   |             |                     |                                                                                          |                                                                                                                                                                                                                                                                                                                                                                                                                                                                          |
|                                        | Requested Procedure Code Sequence | (0032,1064) | None                | CPT-4, DICOMRIS Procedure, site-supplied procedure codes                                 | See remarks for Scheduled Protocol Code Sequence (0040, 0008). The difference is that a procedure code is always passed in this attribute rather than a protocol code                                                                                                                                                                                                                                                                                                    |

### C.8.4 GREYSCALE IMAGE CONSISTENCY

DICOMSRV does not support the Greyscale Standard Display Function

### C.8.5 STANDARD EXTENDED/SPECIALIZED/PRIVATE SOP CLASSES

DICOMSRV does not claim conformance to any Extended, Specialized or Private SOP Classes.

### C.8.6 PRIVATE TRANSFER SYNTAXES

DICOMSRV does not employ any Private Transfer Syntaxes.

**ANNEX D (Informative) CONFORMANCE STATEMENT  
SAMPLE DICOM Image VIEWER**

Disclaimer:

This document is an example DICOM Conformance Statement for a fictional image display device for DICOM images and spectroscopy objects obtained over the network, from interchange media, or from PS 3.10 files loaded from the local file system.

As stated in the annex title, this document is truly informative, and not normative. A conformance statement of an actual product might implement additional services and options as appropriate for its specific purpose. In addition, an actual product might implement the services described in a different manner and, for example, with different characteristics and/or sequencing of activities. In other words, this conformance statement example does not intend to standardize a particular manner that a product might implement DICOM functionality.



**D.0 COVER PAGE**

Company Name: EXAMPLE-Viewing PRODUCTS.

Product Name: SAMPLE DICOM Image Viewer

Version: 1.0-rev. A.1

Internal document number: 4226-xxx-yyy-zzz rev 1

Date: YYYYMMDD

### D.1 COMFORMANCE STATEMENT OVERVIEW

The application supports querying a remote system for a list of DICOM objects that may then be retrieved to the local system. It also supports sending locally loaded images across the network to another system.

All storage SOP Classes defined as of DICOM 2002 can be received, stored and transmitted by the application, but only images and spectroscopy objects may be loaded and viewed. All single and multiframe with grayscale and RGB color (but not palette color, except for Enhanced MR images) images may be displayed.

Only hierarchical query and retrieval is supported.

**Table D.1-1  
NETWORK SERVICES**

| <b>SOP Classes</b>                                         | <b>User of Service (SCU)</b> | <b>Provider of Service (SCP)</b> |
|------------------------------------------------------------|------------------------------|----------------------------------|
| <b>Transfer</b>                                            |                              |                                  |
| Stored Print Storage SOP Class                             | Stored only                  | Yes                              |
| Hardcopy Grayscale Image Storage SOP Class                 | Stored and Viewed            | Yes                              |
| Hardcopy Color Image Storage SOP Class                     | Stored and Viewed            | Yes                              |
| Computed Radiography Image Storage                         | Stored and Viewed            | Yes                              |
| Digital X-Ray Image Storage – For Presentation             | Stored and Viewed            | Yes                              |
| Digital X-Ray Image Storage – For Processing               | Stored only                  | Yes                              |
| Digital Mammography X-Ray Image Storage – For Presentation | Stored and Viewed            | Yes                              |
| Digital Mammography X-Ray Image Storage – For Processing   | Stored only                  | Yes                              |
| Digital Intra-oral X-Ray Image Storage – For Presentation  | Stored and Viewed            | Yes                              |
| Digital Intra-oral X-Ray Image Storage – For Processing    | Stored only                  | Yes                              |
| CT Image Storage                                           | Stored and Viewed            | Yes                              |
| Ultrasound Multi-frame Image Storage (Retired)             | Stored and Viewed            | Yes                              |
| Ultrasound Multi-frame Image Storage                       | Stored and Viewed            | Yes                              |
| MR Image Storage                                           | Stored and Viewed            | Yes                              |
| Enhanced MR Image Storage                                  | Stored and Viewed            | Yes                              |
| MR Spectroscopy Storage                                    | Stored and Viewed            | Yes                              |

|                                                            |                   |     |
|------------------------------------------------------------|-------------------|-----|
| Nuclear Medicine Image Storage (Retired)                   | Stored and Viewed | Yes |
| Ultrasound Image Storage (Retired)                         | Stored and Viewed | Yes |
| Ultrasound Image Storage                                   | Stored and Viewed | Yes |
| Secondary Capture Image Storage                            | Stored and Viewed | Yes |
| Multi-frame Single Bit Secondary Capture Image Storage     | Stored and Viewed | Yes |
| Multi-frame Grayscale Byte Secondary Capture Image Storage | Stored and Viewed | Yes |
| Multi-frame Grayscale Word Secondary Capture Image Storage | Stored and Viewed | Yes |
| Multi-frame True Color Secondary Capture Image Storage     | Stored and Viewed | Yes |
| Standalone Overlay Storage                                 | Stored only       | Yes |
| Standalone Curve Storage                                   | Stored only       | Yes |
| 12-lead ECG Waveform Storage                               | Stored only       | Yes |
| General ECG Waveform Storage                               | Stored only       | Yes |
| Ambulatory ECG Waveform Storage                            | Stored only       | Yes |
| Hemodynamic Waveform Storage                               | Stored only       | Yes |
| Cardiac Electrophysiology Waveform Storage                 | Stored only       | Yes |
| Basic Voice Audio Waveform Storage                         | Stored only       | Yes |
| Standalone Modality LUT Storage                            | Stored only       | Yes |
| Standalone VOI LUT Storage                                 | Stored only       | Yes |
| Grayscale Softcopy Presentation State Storage SOP Class    | Stored and Viewed | Yes |
| X-Ray Angiographic Image Storage                           | Stored and Viewed | Yes |
| X-Ray Radiofluoroscopic Image Storage                      | Stored and Viewed | Yes |
| X-Ray Angiographic Bi-Plane Image Storage (Retired)        | Stored only       | Yes |
| Nuclear Medicine Image Storage                             | Stored and Viewed | Yes |

|                                                |                         |     |
|------------------------------------------------|-------------------------|-----|
| Raw Data Storage                               | Stored only             | Yes |
| VL Image Storage (Retired)                     | Stored and Viewed       | Yes |
| VL Multi-frame Image Storage (Retired)         | Stored and Viewed       | Yes |
| VL Endoscopic Image Storage                    | Stored and Viewed       | Yes |
| VL Microscopic Image Storage                   | Stored and Viewed       | Yes |
| VL Slide-Coordinates Microscopic Image Storage | Stored and Viewed       | Yes |
| VL Photographic Image Storage                  | Stored and Viewed       | Yes |
| Basic Text SR                                  | Stored only             | Yes |
| Enhanced SR                                    | Stored only             | Yes |
| Comprehensive SR                               | Stored only             | Yes |
| Mammography CAD SR                             | Stored only             | Yes |
| Key Object Selection Document                  | Stored only             | Yes |
| Positron Emission Tomography Image Storage     | Stored and Viewed       | Yes |
| Standalone PET Curve Storage                   | Stored only             | Yes |
| RT Image Storage                               | Stored and Viewed       | Yes |
| RT Dose Storage                                | Stored only             | Yes |
| RT Structure Set Storage                       | Stored only             | Yes |
| RT Beams Treatment Record Storage              | Stored only             | Yes |
| RT Plan Storage                                | Stored only             | Yes |
| RT Brachy Treatment Record Storage             | Stored only             | Yes |
| RT Treatment Summary Record Storage            | Stored only             | Yes |
| <b>Query/Retrieve</b>                          |                         |     |
| Study Root Information Model FIND              | Yes – Hierarchical only | No  |
| Study Root Information Model MOVE              | Yes – Hierarchical only | No  |

**Table D.1-2  
MEDIA SERVICES**

| <b>Media Storage Application Profile</b> | <b>Write Files (FSC or FSU)</b> | <b>Read Files (FSR)</b> |
|------------------------------------------|---------------------------------|-------------------------|
| <b>Compact Disk - Recordable</b>         |                                 |                         |
| General Purpose CD-R                     | No                              | Yes                     |
| <b>DVD</b>                               |                                 |                         |
| General Purpose DVD-RAM                  | No                              | Yes                     |



## **D.2 TABLE OF CONTENTS**

A table of contents shall be provided to assist readers in easily finding the needed information.

## D.3 INTRODUCTION

### D.3.1 REVISION HISTORY

| Document Version | Date of Issue    | Author | Description            |
|------------------|------------------|--------|------------------------|
| 1.1              | October 30, 2003 | WG 6   | Version for Final Text |
| 1.2              | August 30, 2007  | WG 6   | Revised Introduction   |

### D.3.2 AUDIENCE, REMARKS, TERMS AND DEFINITIONS, BASICS OF DICOM COMMUNICATION, ABBREVIATIONS, REFERENCES

*See example text in Annex A.3.*

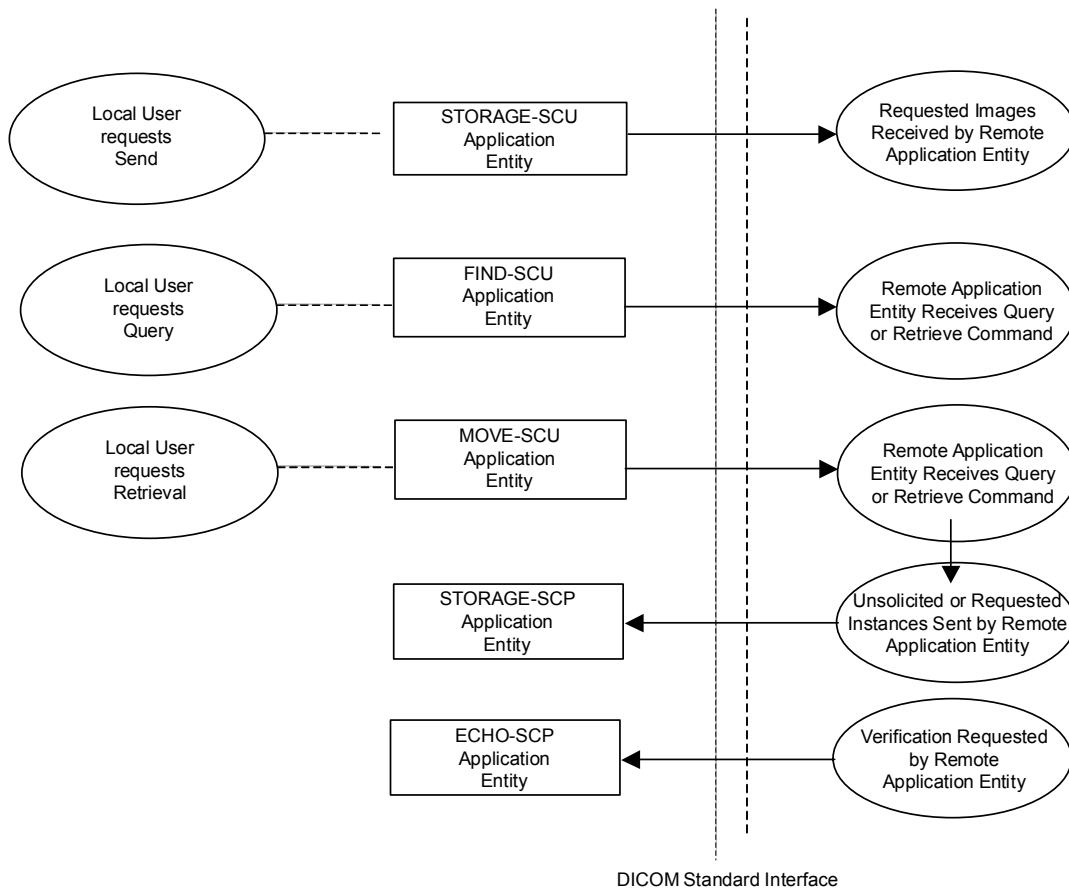
### D.3.3 ADDITIONAL REMARKS FOR THIS EXAMPLE

This document is a sample DICOM Conformance Statement created for DICOM PS3.2. It is to be used solely as an example to illustrate how to create a DICOM Conformance Statement for a workstation supporting a variety of types of DICOM images. The subject of the document, SAMPLE DICOM IMAGE VIEWER, is a fictional product.

## D.4 NETWORKING

### D.4.1 IMPLEMENTATION MODEL

#### D.4.1.1 Application Data Flow



**Figure D.4.1-1**  
**IMPLEMENTATION MODEL**

The application is a single pure Java application that provides both a user interface, internal database and network listener that spawns additional threads as necessary to handle incoming connections, as well as media support.

Conceptually the network services may be modeled as the following separate AEs, though in fact all the AEs share a single (configurable) AE Title:

- ECHO-SCP, which responds to verification requests
- STORAGE-SCP, which receives incoming images and other composite instances
- STORAGE-SCU, which sends outbound images and other composite instances
- FIND-SCU, which queries remote AEs for lists of studies, series and instances



— MOVE-SCU, which retrieves selected studies, series or instances

### D.4.1.2 Functional Definitions of AE's

#### D.4.1.2.1 ECHO-SCP

ECHO-SCP waits in the background for connections, will accept associations with Presentation Contexts for SOP Class of the Verification Service Class, and will respond successfully to echo requests.

#### D.4.1.2.2 STORAGE-SCP

STORAGE-SCP waits in the background for connections, will accept associations with Presentation Contexts for SOP Classes of the Storage Service Class, and will store the received instances to the local database where they may subsequently be listed and viewed through the user interface.

#### D.4.1.2.3 STORAGE-SCU

STORAGE-SCU is activated through the user interface when a user selects instances from the local database or a DICOMDIR, or the currently displayed instance, and requests that they be sent to a remote AE (selected from a pre-configured list).

#### D.4.1.2.4 FIND-SCU

FIND-SCU is activated through the user interface when a user selects a remote AE to query (from a pre-configured list), then initiates a query. Queries are performed recursively from the study through the series and instance levels until all matching instances have been listed.

#### D.4.1.2.5 MOVE-SCU

MOVE-SCU is activated through the user interface when a user selects a study, series or instance for retrieval. A connection to the remote AE is established to initiate and monitor the retrieval and the STORAGE-SCP AE receives the retrieved instances.

### D.4.1.3 Sequencing of Real-World Activities

All SCP activities are performed asynchronously in the background and not dependent on any sequencing.

All SCU activities are sequentially initiated in the user interface, and another activity may not be initiated until the prior activity has completed.

## D.4.2 AE SPECIFICATIONS

### D.4.2.1 ECHO-SCP

#### D.4.2.1.1 SOP Classes

ECHO-SCP provide Standard Conformance to the following SOP Class(es):

**Table D.4.2-1  
SOP CLASSES SUPPORTED BY ECHO-SCP**

| SOP Class Name         | SOP Class UID     | SCU | SCP |
|------------------------|-------------------|-----|-----|
| Verification SOP Class | 1.2.840.10008.1.1 | No  | Yes |

#### D.4.2.1.2 Association Policies

##### D.4.2.1.2.1 General

ECHO-SCP accepts but never initiates associations.

**Table D.4.2-2  
MAXIMUM PDU SIZE RECEIVED AS A SCP FOR ECHO-SCP**

- Standard -

|                           |           |
|---------------------------|-----------|
| Maximum PDU size received | Unlimited |
|---------------------------|-----------|

**D.4.2.1.2.2 Number of Associations**

**Table D.4.2-3  
NUMBER OF ASSOCIATIONS AS A SCP FOR ECHO-SCP**

|                                             |           |
|---------------------------------------------|-----------|
| Maximum number of simultaneous associations | Unlimited |
|---------------------------------------------|-----------|

**D.4.2.1.2.3 Asynchronous Nature**

ECHO-SCP will only allow a single outstanding operation on an Association. Therefore, ECHO-SCP will not perform asynchronous operations window negotiation.

**D.4.2.1.2.4 Implementation Identifying Information**

**Table D.4.2-4  
DICOM IMPLEMENTATION CLASS AND VERSION FOR ECHO-SCP**

|                             |                              |
|-----------------------------|------------------------------|
| Implementation Class UID    | xxxxxxxxxx.yy.etc.ad.inf.usw |
| Implementation Version Name | Viewer1.0                    |

**D.4.2.1.3 Association Initiation Policy**

ECHO-SCP does not initiate associations.

**D.4.2.1.4 Association Acceptance Policy**

When ECHO-SCP accepts an association, it will respond to echo requests. If the Called AE Title does not match the pre-configured AE Title shared by all the SCPs of the application, the association will be rejected.

**D.4.2.1.4.1 Activity – Receive Echo Request**

**D.4.2.1.4.1.1 Description and Sequencing of Activities**

**D.4.2.1.4.1.2 Accepted Presentation Contexts**

**Table D.4.2-5  
ACCEPTABLE PRESENTATION CONTEXTS FOR ECHO-SCP AND RECEIVE ECHO REQUEST**

| Presentation Context Table |                   |                           |                     |      |                      |
|----------------------------|-------------------|---------------------------|---------------------|------|----------------------|
| Abstract Syntax            |                   | Transfer Syntax           |                     | Role | Extended Negotiation |
| Name                       | UID               | Name                      | UID                 |      |                      |
| Verification               | 1.2.840.10008.1.1 | Implicit VR Little Endian | 1.2.840.10008.1.2   | SCP  | None                 |
|                            |                   | Explicit VR Little Endian | 1.2.840.10008.1.2.1 | SCP  | None                 |
|                            |                   | Explicit VR Big Endian    | 1.2.840.10008.1.2.2 | SCP  | None                 |

**D.4.2.1.4.1.2.1 Extended Negotiation**

No extended negotiation is performed.

**D.4.2.1.4.1.3 SOP Specific Conformance**

**D.4.2.1.4.1.3.1 SOP Specific Conformance to Verification SOP Class**

ECHO-SCP provides standard conformance to the Verification Service Class.

**D.4.2.1.4.1.3.2 Presentation Context Acceptance Criterion**

ECHO-SCP will always accept any Presentation Context for the supported SOP Classes with the supported Transfer Syntaxes. More than one proposed Presentation Context will be accepted for the same Abstract Syntax if the Transfer Syntax is supported, whether or not it is the same as another Presentation Context.

**D.4.2.1.4.1.3.3 Transfer Syntax Selection Policies**

ECHO-SCP prefers explicit Transfer Syntaxes. If offered a choice of Transfer Syntaxes in a Presentation Context, it will apply the following priority to the choice of Transfer Syntax:

- a. first encountered explicit Transfer Syntax,
- b. default Transfer Syntax.

ECHO-SCP will accept duplicate Presentation Contexts, that is, if it is offered multiple Presentation Contexts, each of which offers acceptable Transfer Syntaxes, it will accept all Presentation Contexts, applying the same priority for selecting a Transfer Syntax for each.

**D.4.2.2 STORAGE-SCP**

**D.4.2.2.1 SOP Classes**

STORAGE-SCP provide Standard Conformance to the following SOP Class(es):

**Table D.4.2-6  
SOP CLASSES SUPPORTED BY STORAGE-SCP**

| SOP Class Name                                             | SOP Class UID                 | SCU | SCP |
|------------------------------------------------------------|-------------------------------|-----|-----|
| Stored Print Storage                                       | 1.2.840.10008.5.1.1.27        | No  | Yes |
| Hardcopy Grayscale Image Storage                           | 1.2.840.10008.5.1.1.29        | No  | Yes |
| Hardcopy Color Image Storage                               | 1.2.840.10008.5.1.1.30        | No  | Yes |
| Computed Radiography Image Storage                         | 1.2.840.10008.5.1.4.1.1.1     | No  | Yes |
| Digital X-Ray Image Storage – For Presentation             | 1.2.840.10008.5.1.4.1.1.1.1   | No  | Yes |
| Digital X-Ray Image Storage – For Processing               | 1.2.840.10008.5.1.4.1.1.1.1.1 | No  | Yes |
| Digital Mammography X-Ray Image Storage – For Presentation | 1.2.840.10008.5.1.4.1.1.1.2   | No  | Yes |
| Digital Mammography X-Ray Image Storage – For Processing   | 1.2.840.10008.5.1.4.1.1.1.2.1 | No  | Yes |
| Digital Intra-oral X-Ray Image Storage – For Presentation  | 1.2.840.10008.5.1.4.1.1.1.3   | No  | Yes |
| Digital Intra-oral X-Ray Image Storage – For Processing    | 1.2.840.10008.5.1.4.1.1.1.3.1 | No  | Yes |
| CT Image Storage                                           | 1.2.840.10008.5.1.4.1.1.2     | No  | Yes |
| Ultrasound Multi-frame Image Storage (Retired)             | 1.2.840.10008.5.1.4.1.1.3     | No  | Yes |
| Ultrasound Multi-frame Image Storage                       | 1.2.840.10008.5.1.4.1.1.3.1   | No  | Yes |
| MR Image Storage                                           | 1.2.840.10008.5.1.4.1.1.4     | No  | Yes |

|                                                     |                                |    |     |
|-----------------------------------------------------|--------------------------------|----|-----|
| Enhanced MR Image Storage                           | 1.2.840.10008.5.1.4.1.1.4.1    | No | Yes |
| MR Spectroscopy Storage                             | 1.2.840.10008.5.1.4.1.1.4.2    | No | Yes |
| Standalone Modality LUT Storage                     | 1.2.840.10008.5.1.4.1.1.10     | No | Yes |
| Standalone VOI LUT Storage                          | 1.2.840.10008.5.1.4.1.1.11     | No | Yes |
| Grayscale Softcopy Presentation State Storage       | 1.2.840.10008.5.1.4.1.1.11.1   | No | Yes |
| X-Ray Angiographic Image Storage                    | 1.2.840.10008.5.1.4.1.1.12.1   | No | Yes |
| X-Ray Radiofluoroscopic Image Storage               | 1.2.840.10008.5.1.4.1.1.12.2   | No | Yes |
| X-Ray Angiographic Bi-Plane Image Storage (Retired) | 1.2.840.10008.5.1.4.1.1.12.3   | No | Yes |
| Nuclear Medicine Image Storage                      | 1.2.840.10008.5.1.4.1.1.20     | No | Yes |
| Raw Data Storage                                    | 1.2.840.10008.5.1.4.1.1.66     | No | Yes |
| VL Image Storage (Retired)                          | 1.2.840.10008.5.1.4.1.1.77.1   | No | Yes |
| VL Multi-frame Image Storage (Retired)              | 1.2.840.10008.5.1.4.1.1.77.2   | No | Yes |
| VL Endoscopic Image Storage                         | 1.2.840.10008.5.1.4.1.1.77.1.1 | No | Yes |
| VL Microscopic Image Storage                        | 1.2.840.10008.5.1.4.1.1.77.1.2 | No | Yes |
| VL Slide-Coordinates Microscopic Image Storage      | 1.2.840.10008.5.1.4.1.1.77.1.3 | No | Yes |
| VL Photographic Image Storage                       | 1.2.840.10008.5.1.4.1.1.77.1.4 | No | Yes |
| Basic Text SR                                       | 1.2.840.10008.5.1.4.1.1.88.11  | No | Yes |
| Enhanced SR                                         | 1.2.840.10008.5.1.4.1.1.88.22  | No | Yes |
| Comprehensive SR                                    | 1.2.840.10008.5.1.4.1.1.88.33  | No | Yes |
| Mammography CAD SR                                  | 1.2.840.10008.5.1.4.1.1.88.50  | No | Yes |
| Key Object Selection Document                       | 1.2.840.10008.5.1.4.1.1.88.59  | No | Yes |
| Positron Emission Tomography Image Storage          | 1.2.840.10008.5.1.4.1.1.128    | No | Yes |
| Standalone PET Curve Storage                        | 1.2.840.10008.5.1.4.1.1.129    | No | Yes |
| RT Image Storage                                    | 1.2.840.10008.5.1.4.1.1.481.1  | No | Yes |
| RT Dose Storage                                     | 1.2.840.10008.5.1.4.1.1.481.2  | No | Yes |
| RT Structure Set Storage                            | 1.2.840.10008.5.1.4.1.1.481.3  | No | Yes |
| RT Beams Treatment Record Storage                   | 1.2.840.10008.5.1.4.1.1.481.4  | No | Yes |
| RT Plan Storage                                     | 1.2.840.10008.5.1.4.1.1.481.5  | No | Yes |
| RT Brachy Treatment Record Storage                  | 1.2.840.10008.5.1.4.1.1.481.6  | No | Yes |
| RT Treatment Summary Record Storage                 | 1.2.840.10008.5.1.4.1.1.481.7  | No | Yes |

**D.4.2.2.2 Association Policies**

**D.4.2.2.2.1 General**

STORAGE-SCP accepts but never initiates associations.

**Table D.4.2-7  
MAXIMUM PDU SIZE RECEIVED AS A SCP FOR STORAGE-SCP**

|                           |           |
|---------------------------|-----------|
| Maximum PDU size received | Unlimited |
|---------------------------|-----------|

**D.4.2.2.2 Number of Associations**

**Table D.4.2-8  
NUMBER OF ASSOCIATIONS AS A SCP FOR STORAGE-SCP**

|                                             |           |
|---------------------------------------------|-----------|
| Maximum number of simultaneous associations | Unlimited |
|---------------------------------------------|-----------|

**D.4.2.2.3 Asynchronous Nature**

STORAGE-SCP will only allow a single outstanding operation on an Association. Therefore, STORAGE-SCP will not perform asynchronous operations window negotiation.

**D.4.2.2.4 Implementation Identifying Information**

**Table D.4.2-9  
DICOM IMPLEMENTATION CLASS AND VERSION FOR STORAGE-SCP**

|                             |                                  |
|-----------------------------|----------------------------------|
| Implementation Class UID    | xxxxxxxxxx.yy.etc.ad.inf.us<br>w |
| Implementation Version Name | Viewer1.0                        |

**D.4.2.2.3 Association Initiation Policy**

STORAGE-SCP does not initiate associations.

**D.4.2.2.4 Association Acceptance Policy**

When STORAGE-SCP accepts an association, it will respond to storage requests. If the Called AE Title does not match the pre-configured AE Title shared by all the SCPs of the application, the association will be rejected.

**D.4.2.2.4.1 Activity – Receive Storage Request**

**D.4.2.2.4.1.1 Description and Sequencing of Activities**

As instances are received they are copied to the local file system and a record inserted into the local database. If the received instance is a duplicate of a previously received instance, the old file and database record will be overwritten with the new one.

**D.4.2.2.4.1.2 Accepted Presentation Contexts**

**Table D.4.2-10  
ACCEPTABLE PRESENTATION CONTEXTS FOR  
STORAGE-SCP AND RECEIVE STORAGE REQUEST**

| Presentation Context Table |                   |                           |                     |      |                      |
|----------------------------|-------------------|---------------------------|---------------------|------|----------------------|
| Abstract Syntax            |                   | Transfer Syntax           |                     | Role | Extended Negotiation |
| Name                       | UID               | Name                      | UID                 |      |                      |
| See Table D.4.2-6          | See Table D.4.2-6 | Implicit VR Little Endian | 1.2.840.10008.1.2   | SCP  | None                 |
|                            |                   | Explicit VR Little Endian | 1.2.840.10008.1.2.1 | SCP  | None                 |
|                            |                   | Explicit VR Big Endian    | 1.2.840.10008.1.2.2 | SCP  | None                 |

**D.4.2.2.4.1.2.1 Extended Negotiation**

No extended negotiation is performed, though STORAGE-SCP:

- is a Level 2 Storage SCP (Full – does not discard any data elements)
- does not support digital signatures
- does not coerce any received data elements

**D.4.2.2.4.1.3 SOP Specific Conformance**

**D.4.2.2.4.1.3.1 SOP Specific Conformance to Storage SOP Classes**

STORAGE-SCP provides standard conformance to the Storage Service Class.

When displaying an image in the viewing application, the newest Grayscale Softcopy Presentation State containing references to the image will be automatically applied and the GSPS Presentation Label and Presentation description will be displayed. The user has the option to select any other Presentation States that also references the image. If no Presentation State references the image then no Presentation State will be applied by default.

The Mask Subtraction transformation is not supported by this implementation. It is not possible display Presentation States containing the Mask Subtraction Sequence (0028,6100).

All of the Image Storage SOP Classes listed in Table D.4.2-6 are supported as references from instances of the Grayscale Softcopy Presentation State Storage SOP Class.

**D.4.2.2.4.1.3.2 Presentation Context Acceptance Criterion**

STORAGE-SCP will always accept any Presentation Context for the supported SOP Classes with the supported Transfer Syntaxes. More than one proposed Presentation Context will be accepted for the same Abstract Syntax if the Transfer Syntax is supported, whether or not it is the same as another Presentation Context.

**D.4.2.2.4.1.3.3 Transfer Syntax Selection Policies**

STORAGE-SCP prefers explicit Transfer Syntaxes. If offered a choice of Transfer Syntaxes in a Presentation Context, it will apply the following priority to the choice of Transfer Syntax:

- a. first encountered explicit Transfer Syntax,
- b. default Transfer Syntax.

STORAGE-SCP will accept duplicate Presentation Contexts, that is, if it is offered multiple Presentation Contexts, each of which offers acceptable Transfer Syntaxes, it will accept all Presentation Contexts, applying the same priority for selecting a Transfer Syntax for each.

**D.4.2.2.4.1.3.4 Response Status**

STORAGE-SCP will behave as described in the Table below when generating the C-STORE response command message.

**Table D.4.2-11  
RESPONSE STATUS FOR STORAGE-SCP AND RECEIVE STORAGE REQUEST**

| <b>Service Status</b> | <b>Further Meaning</b>            | <b>Status Codes</b> | <b>Reason</b>                                         |
|-----------------------|-----------------------------------|---------------------|-------------------------------------------------------|
| Refused               | Out of Resources                  | A7xx                | Never sent                                            |
| Error                 | Data Set does not match SOP Class | A9xx                | Never sent – data set is not checked prior to storage |
|                       | Cannot understand                 | Cxxx                | Never sent                                            |

|         |                                   |      |                                                       |
|---------|-----------------------------------|------|-------------------------------------------------------|
| Warning | Coercion of Data Elements         | B000 | Never sent - no coercion is ever performed            |
|         | Data Set does not match SOP Class | B007 | Never sent - data set is not checked prior to storage |
|         | Elements Discarded                | B006 | Never sent – all elements are always stored           |
| Success |                                   | 0000 |                                                       |

### D.4.2.3 STORAGE-SCU

#### D.4.2.3.1 SOP Classes

STORAGE-SCU provide Standard Conformance to the following SOP Class(es):

**Table D.4.2-12  
SOP CLASSES SUPPORTED BY STORAGE-SCU**

| SOP Class Name                                             | SOP Class UID                 | SCU | SCP |
|------------------------------------------------------------|-------------------------------|-----|-----|
| Stored Print Storage                                       | 1.2.840.10008.5.1.1.27        | Yes | No  |
| Hardcopy Grayscale Image Storage                           | 1.2.840.10008.5.1.1.29        | Yes | No  |
| Hardcopy Color Image Storage                               | 1.2.840.10008.5.1.1.30        | Yes | No  |
| Computed Radiography Image Storage                         | 1.2.840.10008.5.1.4.1.1.1     | Yes | No  |
| Digital X-Ray Image Storage – For Presentation             | 1.2.840.10008.5.1.4.1.1.1.1   | Yes | No  |
| Digital X-Ray Image Storage – For Processing               | 1.2.840.10008.5.1.4.1.1.1.1.1 | Yes | No  |
| Digital Mammography X-Ray Image Storage – For Presentation | 1.2.840.10008.5.1.4.1.1.1.2   | Yes | No  |
| Digital Mammography X-Ray Image Storage – For Processing   | 1.2.840.10008.5.1.4.1.1.1.2.1 | Yes | No  |
| Digital Intra-oral X-Ray Image Storage – For Presentation  | 1.2.840.10008.5.1.4.1.1.1.3   | Yes | No  |
| Digital Intra-oral X-Ray Image Storage – For Processing    | 1.2.840.10008.5.1.4.1.1.1.3.1 | Yes | No  |
| CT Image Storage                                           | 1.2.840.10008.5.1.4.1.1.2     | Yes | No  |
| Ultrasound Multi-frame Image Storage (Retired)             | 1.2.840.10008.5.1.4.1.1.3     | Yes | No  |
| Ultrasound Multi-frame Image Storage                       | 1.2.840.10008.5.1.4.1.1.3.1   | Yes | No  |
| MR Image Storage                                           | 1.2.840.10008.5.1.4.1.1.4     | Yes | No  |
| Enhanced MR Image Storage                                  | 1.2.840.10008.5.1.4.1.1.4.1   | Yes | No  |
| MR Spectroscopy Storage                                    | 1.2.840.10008.5.1.4.1.1.4.2   | Yes | No  |
| Standalone Modality LUT Storage                            | 1.2.840.10008.5.1.4.1.1.10    | Yes | No  |
| Standalone VOI LUT Storage                                 | 1.2.840.10008.5.1.4.1.1.11    | Yes | No  |
| Grayscale Softcopy Presentation State                      | 1.2.840.10008.5.1.4.1.1.11.1  | Yes | No  |

|                                                     |                                |     |    |
|-----------------------------------------------------|--------------------------------|-----|----|
| Storage                                             |                                |     |    |
| X-Ray Angiographic Image Storage                    | 1.2.840.10008.5.1.4.1.1.12.1   | Yes | No |
| X-Ray Radiofluoroscopic Image Storage               | 1.2.840.10008.5.1.4.1.1.12.2   | Yes | No |
| X-Ray Angiographic Bi-Plane Image Storage (Retired) | 1.2.840.10008.5.1.4.1.1.12.3   | Yes | No |
| Nuclear Medicine Image Storage                      | 1.2.840.10008.5.1.4.1.1.20     | Yes | No |
| Raw Data Storage                                    | 1.2.840.10008.5.1.4.1.1.66     | Yes | No |
| VL Image Storage (Retired)                          | 1.2.840.10008.5.1.4.1.1.77.1   | Yes | No |
| VL Multi-frame Image Storage (Retired)              | 1.2.840.10008.5.1.4.1.1.77.2   | Yes | No |
| VL Endoscopic Image Storage                         | 1.2.840.10008.5.1.4.1.1.77.1.1 | Yes | No |
| VL Microscopic Image Storage                        | 1.2.840.10008.5.1.4.1.1.77.1.2 | Yes | No |
| VL Slide-Coordinates Microscopic Image Storage      | 1.2.840.10008.5.1.4.1.1.77.1.3 | Yes | No |
| VL Photographic Image Storage                       | 1.2.840.10008.5.1.4.1.1.77.1.4 | Yes | No |
| Basic Text SR                                       | 1.2.840.10008.5.1.4.1.1.88.11  | Yes | No |
| Enhanced SR                                         | 1.2.840.10008.5.1.4.1.1.88.22  | Yes | No |
| Comprehensive SR                                    | 1.2.840.10008.5.1.4.1.1.88.33  | Yes | No |
| Mammography CAD SR                                  | 1.2.840.10008.5.1.4.1.1.88.50  | Yes | No |
| Key Object Selection Document                       | 1.2.840.10008.5.1.4.1.1.88.59  | Yes | No |
| Positron Emission Tomography Image Storage          | 1.2.840.10008.5.1.4.1.1.128    | Yes | No |
| Standalone PET Curve Storage                        | 1.2.840.10008.5.1.4.1.1.129    | Yes | No |
| RT Image Storage                                    | 1.2.840.10008.5.1.4.1.1.481.1  | Yes | No |
| RT Dose Storage                                     | 1.2.840.10008.5.1.4.1.1.481.2  | Yes | No |
| RT Structure Set Storage                            | 1.2.840.10008.5.1.4.1.1.481.3  | Yes | No |
| RT Beams Treatment Record Storage                   | 1.2.840.10008.5.1.4.1.1.481.4  | Yes | No |
| RT Plan Storage                                     | 1.2.840.10008.5.1.4.1.1.481.5  | Yes | No |
| RT Brachy Treatment Record Storage                  | 1.2.840.10008.5.1.4.1.1.481.6  | Yes | No |
| RT Treatment Summary Record Storage                 | 1.2.840.10008.5.1.4.1.1.481.7  | Yes | No |

**D.4.2.3.2 Association Policies**

**D.4.2.3.2.1 General**

STORAGE-SCU initiates but never accepts associations.

**Table D.4.2-13  
MAXIMUM PDU SIZE RECEIVED AS A SCP FOR STORAGE-SCU**

|                           |           |
|---------------------------|-----------|
| Maximum PDU size received | Unlimited |
|---------------------------|-----------|

**D.4.2.3.2.2 Number of Associations**

**Table D.4.2-14  
NUMBER OF ASSOCIATIONS AS A SCP FOR STORAGE-SCU**

|                                             |   |
|---------------------------------------------|---|
| Maximum number of simultaneous associations | 1 |
|---------------------------------------------|---|



**D.4.2.3.2.3 Asynchronous Nature**

STORAGE-SCU will only allow a single outstanding operation on an Association. Therefore, STORAGE-SCU will not perform asynchronous operations window negotiation.

**D.4.2.3.2.4 Implementation Identifying Information**

**Table D.4.2-15  
DICOM IMPLEMENTATION CLASS AND VERSION FOR STORAGE-SCU**

|                             |                                |
|-----------------------------|--------------------------------|
| Implementation Class UID    | xxxxxxxxxxxx.yy.etc.ad.inf.usw |
| Implementation Version Name | Viewer1.0                      |

**D.4.2.3.3 Association Initiation Policy**

STORAGE-SCU attempts to initiate a new association for each instance it attempts to transfer.

**D.4.2.3.3.1 Activity – Send Storage Request**

**D.4.2.3.3.1.1 Description and Sequencing of Activities**

For each instance selected from the user interface to be transferred, a single attempt will be made to transmit it to the selected remote AE. If the send fails, for whatever reason, no retry will be performed, and an attempt will be made to send the next instance.

**D.4.2.3.3.1.2 Proposed Presentation Contexts**

**Table D.4.2-16  
PROPOSED PRESENTATION CONTEXTS FOR STORAGE-SCU AND RECEIVE STORAGE REQUEST**

| Presentation Context Table |                    |                           |                     |      |                      |
|----------------------------|--------------------|---------------------------|---------------------|------|----------------------|
| Abstract Syntax            |                    | Transfer Syntax           |                     | Role | Extended Negotiation |
| Name                       | UID                | Name                      | UID                 |      |                      |
| See Table D.4.2-12         | See Table D.4.2-12 | Implicit VR Little Endian | 1.2.840.10008.1.2   | SCU  | None                 |
|                            |                    | Explicit VR Little Endian | 1.2.840.10008.1.2.1 | SCU  | None                 |
|                            |                    | Explicit VR Big Endian    | 1.2.840.10008.1.2.2 | SCU  | None                 |

STORAGE-SCU will propose Presentation Contexts only for the SOP Class of the instance that is to be transferred.

For that SOP Class, STORAGE-SCU will propose multiple Presentation Contexts, one for each of the supported Transfer Syntaxes, and an additional Presentation Context with all of the supported Transfer Syntaxes, in order to determine which Transfer Syntaxes the remote SCP supports, and which it prefers.

**D.4.2.3.3.1.2.1 Extended Negotiation**

No extended negotiation is performed.

**D.4.2.3.3.1.3 SOP Specific Conformance**

**D.4.2.3.3.1.3.1 SOP Specific Conformance to Storage SOP Classes**

STORAGE-SCU provides standard conformance to the Storage Service Class.

**D.4.2.3.3.1.3.2 Presentation Context Acceptance Criterion**

STORAGE-SCU does not accept associations.

**D.4.2.3.3.1.3.3 Transfer Syntax Selection Policies**

STORAGE-SCU prefers explicit Transfer Syntaxes. If offered a choice of Transfer Syntaxes in the accepted Presentation Contexts, it will apply the following priority to the choice of Presentation Context to use for the C-STORE operation:

- a. first encountered explicit Transfer Syntax,
- b. default Transfer Syntax.

**D.4.2.3.3.1.3.4 Response Status**

STORAGE-SCU will behave as described in the Table below in response to the status returned in the C-STORE response command message.

**Table D.4.2-17  
RESPONSE STATUS FOR STORAGE-SCU AND RECEIVE STORAGE REQUEST**

| <b>Service Status</b> | <b>Further Meaning</b>            | <b>Status Codes</b> | <b>Behavior</b> |
|-----------------------|-----------------------------------|---------------------|-----------------|
| Refused               | Out of Resources                  | A7xx                | Ignored         |
| Error                 | Data Set does not match SOP Class | A9xx                | Ignored         |
|                       | Cannot understand                 | Cxxx                | Ignored         |
| Warning               | Coercion of Data Elements         | B000                | Ignored         |
|                       | Data Set does not match SOP Class | B007                | Ignored         |
|                       | Elements Discarded                | B006                | Ignored         |
| Success               |                                   | 0000                | Ignored         |

**D.4.2.3.4 Association Acceptance Policy**

STORAGE-SCU does not accept associations.

**D.4.2.4 FIND-SCU**

**D.4.2.4.1 SOP Classes**

FIND-SCU provide Standard Conformance to the following SOP Class(es):

**Table D.4.2-18  
SOP CLASSES SUPPORTED BY FIND-SCU**

| <b>SOP Class Name</b>                              | <b>SOP Class UID</b>        | <b>SCU</b> | <b>SCP</b> |
|----------------------------------------------------|-----------------------------|------------|------------|
| Study Root Query/Retrieve Information Model – FIND | 1.2.840.10008.5.1.4.1.2.2.1 | Yes        | No         |

**D.4.2.4.2 Association Policies**

**D.4.2.4.2.1 General**

FIND-SCU initiates but never accepts associations.

**Table D.4.2-19  
Maximum PDU size received as a SCP for FIND-SCU**

|                           |           |
|---------------------------|-----------|
| Maximum PDU size received | Unlimited |
|---------------------------|-----------|

**D.4.2.4.2.2 Number of Associations**

**Table D.4.2-20  
Number of Associations as a SCP for FIND-SCU**

|                                             |   |
|---------------------------------------------|---|
| Maximum number of simultaneous associations | 1 |
|---------------------------------------------|---|

**D.4.2.4.2.3 Asynchronous Nature**

FIND-SCU will only allow a single outstanding operation on an Association. Therefore, FIND-SCU will not perform asynchronous operations window negotiation.

**D.4.2.4.2.4 Implementation Identifying Information**

**Table D.4.2-21  
DICOM Implementation Class and Version for FIND-SCU**

|                             |                                  |
|-----------------------------|----------------------------------|
| Implementation Class UID    | xxxxxxxxxx.yy.etc.ad.inf.us<br>w |
| Implementation Version Name | Viewer1.0                        |

**D.4.2.4.3 Association Initiation Policy**

FIND-SCU attempts to initiate a new association when the user performs the query action from the user interface. If this involves recursive queries for lower query levels in the hierarchy, these will be performed on the same association.

**D.4.2.4.3.1 Activity – Query Remote AE**

**D.4.2.4.3.1.1 Description and Sequencing of Activities**

A single attempt will be made to query the remote AE. If the query fails, for whatever reason, no retry will be performed.

**D.4.2.4.3.1.2 Proposed Presentation Contexts**

**Table D.4.2-22  
Proposed Presentation Contexts for FIND-SCU and Query Remote AE**

| Presentation Context Table |                    |                           |                     |      |                      |
|----------------------------|--------------------|---------------------------|---------------------|------|----------------------|
| Abstract Syntax            |                    | Transfer Syntax           |                     | Role | Extended Negotiation |
| Name                       | UID                | Name                      | UID                 |      |                      |
| See Table D.4.2-18         | See Table D.4.2-18 | Implicit VR Little Endian | 1.2.840.10008.1.2   | SCU  | None                 |
|                            |                    | Explicit VR Little Endian | 1.2.840.10008.1.2.1 | SCU  | None                 |

|  |  |                        |                     |     |      |
|--|--|------------------------|---------------------|-----|------|
|  |  | Explicit VR Big Endian | 1.2.840.10008.1.2.2 | SCU | None |
|--|--|------------------------|---------------------|-----|------|

FIND-SCU will propose multiple Presentation Contexts, one for each of the supported Transfer Syntaxes, and an additional Presentation Context with all of the supported Transfer Syntaxes, in order to determine which Transfer Syntaxes the remote SCP supports, and which it prefers.

**D.4.2.4.3.1.2.1 Extended Negotiation**

No extended negotiation is performed.

In particular, relational queries are not supported.

**D.4.2.4.3.1.3 SOP Specific Conformance**

**D.4.2.4.3.1.3.1 SOP Specific Conformance to C-FIND SOP Classes**

FIND-SCU provides standard conformance to the supported C-FIND SOP Classes.

Only a single information model, Study Root, is supported.

All queries are initiated at the highest level of the information model (the STUDY level), and then for each response received, recursively repeated at the next lower levels (the SERIES and then IMAGE levels), in order to completely elucidate the "tree" of instances available on the remote AE (from which the user may subsequently request a retrieval at any level).

No CANCEL requests are ever issued.

Unexpected attributes returned in a C-FIND response (those not requested) are listed in the browser at the appropriate level if present in the dictionary. Requested return attributes not returned by the SCP are ignored. Non-matching responses returned by the SCP due to unsupported (hopefully optional) matching keys are not filtered locally by the FIND-SCU and thus will still be presented in the browser. No attempt is made to filter out duplicate responses.

Specific Character Set will always be included at every query level. If present in the response, Specific Character Set will be used to identify character sets other than the default character set for display of strings in the browser.

**Table D.4.2-23  
STUDY ROOT REQUEST IDENTIFIER FOR FIND-SCU**

| Name                  | Tag         | Types of Matching |
|-----------------------|-------------|-------------------|
| <b>STUDY Level</b>    |             |                   |
| Patient's ID          | (0010,0020) | S,*,U             |
| Patient's Name        | (0010,0010) | S,*,U             |
| Patient's Birth Date  | (0010,0030) | S,*,U,R           |
| Patient's Sex         | (0010,0040) | S,*,U             |
| Patient's Birth Time  | (0010,0032) | S,*,U,R           |
| Other Patient's ID's  | (0010,1000) | S,*,U             |
| Other Patient's Names | (0010,1001) | S,*,U             |
| Ethnic Group          | (0010,2160) | S,*,U             |
| Patient Comments      | (0010,4000) | S,*,U             |
| Study ID              | (0020,0010) | S,*,U             |
| Study Description     | (0008,1030) | S,*,U             |

|                                    |             |         |
|------------------------------------|-------------|---------|
| Modalities In Study                | (0008,0061) | S,*,U   |
| Study Date                         | (0008,0020) | S,*,U,R |
| Study Time                         | (0008,0030) | S,*,U,R |
| Referring Physician's Name         | (0008,0090) | S,*,U   |
| Accession Number                   | (0008,0050) | S,*,U   |
| Physician of Record                | (0008,1048) | S,*,U   |
| Name of Physician(s) Reading Study | (0008,1060) | S,*,U   |
| Admitting Diagnoses Description    | (0008,1080) | S,*,U   |
| Patient's Age                      | (0010,1010) | S,*,U   |
| Patient's Size                     | (0010,1020) | S,*,U   |
| Patient's Weight                   | (0010,1030) | S,*,U   |
| Occupation                         | (0010,2180) | S,*,U   |
| Additional Patient History         | (0010,21B0) | S,*,U   |
| Study Instance UID                 | (0020,000D) | UNIQUE  |
| <b>SERIES Level</b>                |             |         |
| Series Number                      | (0020,0011) | S,*,U   |
| Series Description                 | (0008,103E) | S,*,U   |
| Modality                           | (0008,0060) | S,*,U   |
| Series Date                        | (0008,0021) | S,*,U   |
| Series Time                        | (0008,0031) | S,*,U   |
| Performing Physician's Name        | (0008,1050) | S,*,U   |
| Protocol Name                      | (0018,1030) | S,*,U   |
| Operator's Name                    | (0008,1070) | S,*,U   |
| Laterality                         | (0020,0060) | S,*,U   |
| Body Part Examined                 | (0018,0015) | S,*,U   |
| Manufacturer                       | (0008,0070) | S,*,U   |
| Manufacturer's Model Name          | (0008,1090) | S,*,U   |
| Station Name                       | (0008,1010) | S,*,U   |
| Institution Name                   | (0008,0080) | S,*,U   |
| Institutional Department Name      | (0008,1040) | S,*,U   |
| Series Instance UID                | (0020,000E) | UNIQUE  |
| <b>IMAGE Level</b>                 |             |         |
| Instance Number                    | (0020,0013) | S,*,U   |
| Image Comments                     | (0020,4000) | S,*,U   |
| Content Date                       | (0008,0023) | S,*,U,R |
| Content Time                       | (0008,0033) | S,*,U,R |
| Image Type                         | (0008,0008) | S,*,U   |
| Acquisition Number                 | (0020,0012) | S,*,U   |
| Acquisition Date                   | (0008,0022) | S,*,U,R |
| Acquisition Time                   | (0008,0032) | S,*,U,R |

|                                   |             |         |
|-----------------------------------|-------------|---------|
| Acquisition Date Time             | (0008,002a) | S,*,U,R |
| Derivation Description            | (0008,2111) | S,*,U   |
| Contrast/Bolus Agent              | (0018,0010) | S,*,U   |
| Quality Control Image             | (0028,0300) | S,*,U   |
| Burned In Annotation              | (0028,0301) | S,*,U   |
| Lossy Image Compression           | (0028,2110) | S,*,U   |
| Lossy Image Compression Ratio     | (0028,2112) | S,*,U   |
| Number of Frames                  | (0028,0008) | S,*,U   |
| SOP Instance UID                  | (0008,0018) | UNIQUE  |
| SOP Class UID                     | (0008,0016) | NONE    |
| <b>Common to all query levels</b> |             |         |
| Specific Character Set            | (0008,0005) | S,*,U   |

Types of Matching:

The types of Matching supported by the C-FIND SCU. An "S" indicates the identifier attribute uses Single Value Matching, an "R" indicates Range Matching, a "\*" indicates wildcard matching, a 'U' indicates Universal Matching, and an 'L' indicates that UID lists are sent. "NONE" indicates that no matching is supported, but that values for this Element are requested to be returned (i.e. universal matching), and "UNIQUE" indicates that this is the Unique Key for that query level, in which case Universal Matching or Single Value Matching is used depending on the query level.

**D.4.2.4.3.1.3.2 Presentation Context Acceptance Criterion**

FIND-SCU does not accept associations.

**D.4.2.4.3.1.3.3 Transfer Syntax Selection Policies**

FIND-SCU prefers explicit Transfer Syntaxes. If offered a choice of Transfer Syntaxes in the accepted Presentation Contexts, it will apply the following priority to the choice of Presentation Context to use for the C-STORE operation:

- a. first encountered explicit Transfer Syntax,
- b. default Transfer Syntax.

**D.4.2.4.3.1.3.4 Response Status**

FIND-SCU will behave as described in Table D.4.2-24 in response to the status returned in the C-FIND response command message(s).

**Table D.4.2-24  
RESPONSE STATUS FOR FIND-SCU AND QUERY REMOTE AE REQUEST**

| Service Status | Further Meaning                     | Status Codes | Behavior                                                   |
|----------------|-------------------------------------|--------------|------------------------------------------------------------|
| Refused        | Out of Resources                    | A700         | Current query is terminated;<br>remaining queries continue |
| Error          | Identifier does not match SOP Class | A900         | Current query is terminated;<br>remaining queries continue |
|                | Unable to process                   | Cxxx         | Current query is terminated;<br>remaining queries continue |
| Cancel         | Matching                            | FE00         | Ignored (should never occur, since                         |

|         |                                                                                                                                      |      |                                                                               |
|---------|--------------------------------------------------------------------------------------------------------------------------------------|------|-------------------------------------------------------------------------------|
|         | terminated due to Cancel request                                                                                                     |      | cancel never issued)                                                          |
| Success | Matching is complete - No final Identifier is supplied                                                                               | 0000 | Current query is terminated; remaining queries continue                       |
| Pending | Matches are continuing - Current Match is supplied and any Optional Keys were supported in the same manner as Required Keys          | FF00 | Identifier used to populate browser and trigger recursive lower level queries |
|         | Matches are continuing - Warning that one or more Optional Keys were not supported for existence and/or matching for this Identifier | FF01 | Identifier used to populate browser and trigger recursive lower level queries |

**D.4.2.4.4 Association Acceptance Policy**

FIND-SCU does not accept associations.

**D.4.2.5 MOVE-SCU**

**D.4.2.5.1 SOP Classes**

MOVE-SCU provide Standard Conformance to the following SOP Class(es):

**Table D.4.2-25  
SOP CLASSES SUPPORTED BY MOVE-SCU**

| SOP Class Name                                     | SOP Class UID               | SCU | SCP |
|----------------------------------------------------|-----------------------------|-----|-----|
| Study Root Query/Retrieve Information Model – MOVE | 1.2.840.10008.5.1.4.1.2.2.2 | Yes | No  |

**D.4.2.5.2 Association Policies**

**D.4.2.5.2.1 General**

MOVE-SCU initiates but never accepts associations.

**Table D.4.2-26  
MAXIMUM PDU SIZE RECEIVED AS A SCP FOR MOVE-SCU**

|                           |           |
|---------------------------|-----------|
| Maximum PDU size received | Unlimited |
|---------------------------|-----------|

**D.4.2.5.2.2 Number of Associations**

**Table D.4.2-27  
NUMBER OF ASSOCIATIONS AS A SCP FOR MOVE-SCU**

- Standard -

|                                             |   |
|---------------------------------------------|---|
| Maximum number of simultaneous associations | 1 |
|---------------------------------------------|---|

**D.4.2.5.2.3 Asynchronous Nature**

MOVE-SCU will only allow a single outstanding operation on an Association. Therefore, MOVE-SCU will not perform asynchronous operations window negotiation.

**D.4.2.5.2.4 Implementation Identifying Information**

**Table D.4.2-28  
DICOM IMPLEMENTATION CLASS AND VERSION FOR MOVE-SCU**

|                             |                                |
|-----------------------------|--------------------------------|
| Implementation Class UID    | xxxxxxxxxxxx.yy.etc.ad.inf.usw |
| Implementation Version Name | Viewer1.0                      |

**D.4.2.5.3 Association Initiation Policy**

MOVE-SCU attempts to initiate a new association when the user performs the retrieve action from the user interface.

**D.4.2.5.3.1 Activity – Retrieve From Remote AE**

**D.4.2.5.3.1.1 Description and Sequencing of Activities**

For the entity (study, series or instance) selected from the user interface to be retrieved, a single attempt will be made to retrieve it from the selected remote AE. If the retrieve fails, for whatever reason, no retry will be performed.

**D.4.2.5.3.1.2 Proposed Presentation Contexts**

**Table D.4.2-29  
PROPOSED PRESENTATION CONTEXTS FOR MOVE-SCU AND RETRIEVE FROM REMOTE AE**

| Presentation Context Table |                    |                           |                     |      |                      |
|----------------------------|--------------------|---------------------------|---------------------|------|----------------------|
| Abstract Syntax            |                    | Transfer Syntax           |                     | Role | Extended Negotiation |
| Name                       | UID                | Name                      | UID                 |      |                      |
| See Table D.4.2-25         | See Table D.4.2-25 | Implicit VR Little Endian | 1.2.840.10008.1.2   | SCP  | None                 |
|                            |                    | Explicit VR Little Endian | 1.2.840.10008.1.2.1 | SCP  | None                 |
|                            |                    | Explicit VR Big Endian    | 1.2.840.10008.1.2.2 | SCP  | None                 |

MOVE-SCU will propose multiple Presentation Contexts, one for each of the supported Transfer Syntaxes, and an additional Presentation Context with all of the supported Transfer Syntaxes, in order to determine which Transfer Syntaxes the remote SCP supports, and which it prefers.

**D.4.2.5.3.1.2.1 Extended Negotiation**

No extended negotiation is performed.

In particular, relational retrievals are not supported.



**D.4.2.5.3.1.3 SOP Specific Conformance**

**D.4.2.5.3.1.3.1 SOP Specific Conformance to C-FIND SOP Classes**

MOVE-SCU provides standard conformance to the supported C-MOVE SOP Classes.

Only a single information model, Study Root, is supported.

A retrieval will be performed at the STUDY, SERIES or IMAGE level depending on what level of entity has been selected by the user in the browser.

No CANCEL requests are ever issued.

The retrieval is performed from the AE that was specified in the Retrieve AE attribute returned from the query performed by FIND-SCU. The instances are retrieved to the current application's local database by specifying the destination as the AE Title of the STORE-SCP AE of the local application. This implies that the remote C-MOVE SCP must be preconfigured to determine the presentation address corresponding to the STORE-SCP AE. The STORE-SCP AE will accept storage requests addressed to it from anywhere, so no pre-configuration of the local application to accept from the remote AE is necessary (except in so far as it was necessary to configure FIND-SCU).

**Table D.4.2-30  
STUDY ROOT REQUEST IDENTIFIER FOR MOVE-SCU**

| Name                | Tag         | Unique, Matching or Return Key |
|---------------------|-------------|--------------------------------|
| <b>STUDY level</b>  |             |                                |
| Study Instance UID  | (0020,000D) | U                              |
| <b>SERIES level</b> |             |                                |
| Series Instance UID | (0020,000E) | U                              |
| <b>IMAGE level</b>  |             |                                |
| SOP Instance UID    | (0008,0018) | U                              |

**D.4.2.5.3.1.3.2 Presentation Context Acceptance Criterion**

MOVE-SCU does not accept associations.

**D.4.2.5.3.1.3.3 Transfer Syntax Selection Policies**

MOVE-SCU prefers explicit Transfer Syntaxes. If offered a choice of Transfer Syntaxes in the accepted Presentation Contexts, it will apply the following priority to the choice of Presentation Context to use for the C-STORE operation:

- a. first encountered explicit Transfer Syntax,

**D.4.2.5.3.1.3.4 Response Status**

MOVE-SCU will behave as described in the Table below in response to the status returned in the C-MOVE response command message(s).

**Table D.4.2-31  
RESPONSE STATUS FOR MOVE-SCU AND RETRIEVE FROM REMOTE AE REQUEST**

| Service Status | Further Meaning                                  | Status Codes | Related Fields | Behavior                |
|----------------|--------------------------------------------------|--------------|----------------|-------------------------|
| Refused        | Out of Resources - Unable to calculate number of | A701         | (0000,0902)    | Retrieval is terminated |

|         |                                                     |      |                                                          |                                                                             |
|---------|-----------------------------------------------------|------|----------------------------------------------------------|-----------------------------------------------------------------------------|
|         | matches                                             |      |                                                          |                                                                             |
|         | Out of Resources - Unable to perform sub-operations | A702 | (0000,1020)<br>(0000,1021)<br>(0000,1022)<br>(0000,1023) | Retrieval is terminated                                                     |
|         | Move Destination unknown                            | A801 | (0000,0902)                                              | Retrieval is terminated                                                     |
| Failed  | Identifier does not match SOP Class                 | A900 | (0000,0901)<br>(0000,0902)                               | Retrieval is terminated                                                     |
|         | Unable to process                                   | Cxxx | (0000,0901)<br>(0000,0902)                               | Retrieval is terminated                                                     |
| Cancel  | Sub-operations terminated due to Cancel Indication  | FE00 | (0000,1020)<br>(0000,1021)<br>(0000,1022)<br>(0000,1023) | Retrieval is terminated<br>(should never occur, since cancels never issued) |
| Warning | Sub-operations Complete - One or more Failures      | B000 | (0000,1020)<br>(0000,1022)<br>(0000,1023)                | Retrieval is terminated                                                     |
| Success | Sub-operations Complete - No Failures               | 0000 | (0000,1020)<br>(0000,1021)<br>(0000,1022)<br>(0000,1023) | Retrieval is terminated                                                     |
| Pending | Sub-operations are continuing                       | FF00 | (0000,1020)<br>(0000,1021)<br>(0000,1022)<br>(0000,1023) | Retrieval continues                                                         |

**D.4.2.5.3.1.3.5 Sub-operation dependent behavior**

Since the C-MOVE operation is dependent on completion of C-STORE sub-operations that are occurring on a separate association, the question of failure of operations on the other association(s) must be considered.

MOVE-SCU completely ignores whatever activities are taking place in relation to the STORAGE-SCP AE that is receiving the retrieved instances. Once the C-MOVE has been initiated it runs to completion (or failure) as described in the C-MOVE response command message(s). There is no attempt by MOVE-SCU to confirm that instances have actually been successfully received or locally stored.

Whether or not completely or partially successful retrievals are made available in the local database to the user is purely dependent on the success or failure of the C-STORE sub-operations, not on any explicit action by MOVE-SCU.

Whether or not the remote AE attempts to retry any failed C-STORE sub-operations is beyond the control of MOVE-SCU.

If the association on which the C-MOVE was issued is aborted for any reason, whether or not the C-STORE sub-operations continue is dependent on the remote AE; the local STORAGE-SCP will continue to accept associations and storage operations regardless.

**D.4.2.5.4 Association Acceptance Policy**

MOVE-SCU does not accept associations.

### D.4.3 NETWORK INTERFACES

#### D.4.3.1 Physical Network Interface

The application is indifferent to the physical medium over which TCP/IP executes; which is dependent on the underlying operating system and hardware.

#### D.4.3.2 Additional Protocols

When host names rather than IP addresses are used in the configuration properties to specify presentation addresses for remote AEs, the application is dependent on the name resolution mechanism of the underlying operating system.

#### D.4.3.3 IPv4 and IPv6 Support

This product supports both IPv4 and IPv6. It does not utilize any of the optional configuration identification or security features of IPv6.

### D.4.4 CONFIGURATION

All configuration is performed through the use of Java properties file(s) stored in pre-defined locations that are specific to the underlying operating system. Refer to the Release Notes for specific details.

#### D.4.4.1 AE Title/Presentation Address Mapping

The Calling AE Title of the local application is configurable in the preferences file, and is shared by all of the AEs. The mapping of the logical name by which remote AEs are described in the user interface to Called AE Titles as well as presentation address (hostname or IP address and port number) is configurable in the preferences file.

#### D.4.4.2 Parameters

**Table D.4.4-1  
CONFIGURATION PARAMETERS TABLE**

| Parameter                                                                                                         | Configurable | Default Value |
|-------------------------------------------------------------------------------------------------------------------|--------------|---------------|
| <b>General Parameters</b>                                                                                         |              |               |
| PDU Size                                                                                                          | No           | 16kB          |
| Time-out waiting for acceptance or rejection Response to an Association Open Request. (Application Level timeout) | No           | None          |
| General DIMSE level time-out values                                                                               | No           | None          |
| Time-out waiting for response to TCP/IP connect() request. (Low-level timeout)                                    | No           | None          |
| Time-out waiting for acceptance of a TCP/IP message over the network. (Low-level timeout)                         | No           | None          |
| Time-out for waiting for data between TCP/IP packets. (Low-level timeout)                                         | No           | None          |
| Any changes to default TCP/IP settings, such as configurable stack parameters.                                    | No           | None          |
| <b>AE Specific Parameters (all AEs)</b>                                                                           |              |               |
| Size constraint in maximum object size                                                                            | No           | None          |
| Maximum PDU size the AE can receive (see note 1)                                                                  | No           | Unlimited     |
| Maximum PDU size the AE can send                                                                                  | No           | Unlimited     |
| AE specific DIMSE level time-out values                                                                           | No           | None          |
| Number of simultaneous Associations by Service and/or SOP Class                                                   | No           | Unlimited     |

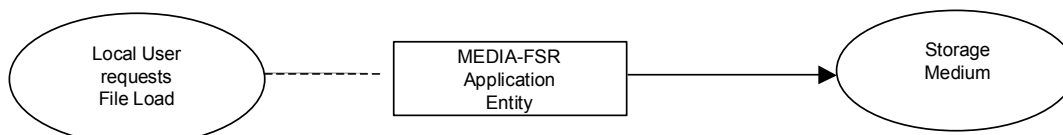
| <b>Parameter</b>                       | <b>Configurable</b> | <b>Default Value</b>                                         |
|----------------------------------------|---------------------|--------------------------------------------------------------|
| <b>General Parameters</b>              |                     |                                                              |
| SOP Class support                      | No                  | All supported SOP Classes always proposed and accepted       |
| Transfer Syntax support                | No                  | All supported Transfer Syntaxes always proposed and accepted |
| Other parameters that are configurable | No                  | None                                                         |

Notes: 1. Though the application can support unlimited PDU sizes, it will never offer a Maximum Received PDU Length of zero (unlimited) since this triggers a bug in some older systems.

## D.5 MEDIA INTERCHANGE

### D.5.1 IMPLEMENTATION MODEL

#### D.5.1.1 Application Data Flow



**Figure D.5.1-1.  
IMPLEMENTATION MODEL**

The application is a single pure Java application that provides a user interface, network support and media support as a File Set Reader.

Conceptually it may be modeled as the following single AE:

- MEDIA-FSR, which loads a user-selected PS 3.10 compliant file, which may be a DICOMDIR or an image or spectroscopy object, either from the local file system or from PS 3.12 compliant media according to one of the General Purpose Media Application Profiles of PS 3.11 (CD-R or DVD-RAM)

In effect, the application is media-neutral, since the user is required to browse and locate the DICOMDIR file. Furthermore, any DICOM image or spectroscopy object encoded in one of the standard uncompressed Transfer Syntaxes may be loaded, even in the absence of a PS 3.10 compliant meta-information header, in which case a “best guess” at the Transfer Syntax will be made.

Compressed Transfer Syntaxes are not supported, which limits the Media Application Profiles supported.

#### D.5.1.2 Functional Definitions of AE’s

##### D.5.1.2.1 MEDIA-FSR

MEDIA-FSR is activated through the user interface to select directories, images and spectra for display, import into the local database or network transmission.

##### D.5.1.3 Sequencing of Real-World Activities

All FSR activities are sequentially initiated in the user interface, and another activity may not be initiated until the prior activity has completed.

### D.5.2 AE SPECIFICATIONS

#### D.5.2.1 MEDIA-FSR

MEDIA-FSR provides standard conformance to the Media Storage Service Class.

**Table D.5.2-1  
APPLICATION PROFILES, ACTIVITIES, AND ROLES FOR MEDIA-FSR**

| Application Profiles Supported | Real World Activity    | Role |  |
|--------------------------------|------------------------|------|--|
| STD-GEN-CD                     | Load directory or file | FSR  |  |
| STD-GEN-DVD-RAM                | Load directory or file | FSR  |  |

Note: The application is media neutral and dependent on the underlying hardware. Any (non-secure) General Purpose Profile can be supported.

#### **D.5.2.1.1 File Meta Information for the Application Entity**

Not applicable, since MEDIA-FSR is not an FSC or FSU.

#### **D.5.2.1.2 Real World Activities**

##### **D.5.2.1.2.1 Activity – Load Directory or File**

MEDIA-FSR is activated through the user interface when a user selects the File load operation.

If the loaded file is a DICOMDIR, a browser will be displayed, from which instances may be selected and in turn loaded for display, imported into the local database or sent to a remote AE over the network.

If the file is an image or spectroscopy instance, it will be loaded and displayed.

##### **D.5.2.1.2.1.1 Application Profile Specific Conformance**

There are no extensions or specializations.

### **D.5.3 AUGMENTED AND PRIVATE PROFILES**

#### **D.5.3.1 Augmented Profiles**

None.

#### **D.5.3.2 Private Profiles**

None.

### **D.5.4 MEDIA CONFIGURATION**

None.

## D.6 SUPPORT OF CHARACTER SETS

### D.6.1 OVERVIEW

The application supports all extended character sets defined in the DICOM 2002 standard, including single-byte and multi-byte character sets as well as code extension techniques using ISO 2022 escapes.

Support extends to correctly decoding and displaying the correct symbol for all names and strings found in the DICOMDIR, in storage instances from media and received over the network, and in the local database.

No specific support for sorting of strings other than in the default character set is provided in the browsers.

### D.6.2 CHARACTER SETS

In addition to the default character repertoire, the Defined Terms for Specific Character Set in Table 6.2-1 are supported:

**Table D.6.2-1  
SUPPORTED SPECIFIC CHARACTER SET DEFINED TERMS**

| <b>Character Set Description</b> | <b>Defined Term</b> |
|----------------------------------|---------------------|
| Latin alphabet No. 1             | ISO_IR 100          |
| Latin alphabet No. 2             | ISO_IR 101          |
| Latin alphabet No. 3             | ISO_IR 109          |
| Latin alphabet No. 4             | ISO_IR 110          |
| Cyrillic                         | ISO_IR 144          |
| Arabic                           | ISO_IR 127          |
| Greek                            | ISO_IR 126          |
| Hebrew                           | ISO_IR 138          |
| Latin alphabet No. 5             | ISO_IR 148          |
| Japanese                         | ISO_IR 13           |
| Thai                             | ISO_IR 166          |
| Default repertoire               | ISO 2022 IR 6       |
| Latin alphabet No. 1             | ISO 2022 IR 100     |
| Latin alphabet No. 2             | ISO 2022 IR 101     |
| Latin alphabet No. 3             | ISO 2022 IR 109     |
| Latin alphabet No. 4             | ISO 2022 IR 110     |
| Cyrillic                         | ISO 2022 IR 144     |
| Arabic                           | ISO 2022 IR 127     |
| Greek                            | ISO 2022 IR 126     |
| Hebrew                           | ISO 2022 IR 138     |
| Latin alphabet No. 5             | ISO 2022 IR 148     |

|          |                 |
|----------|-----------------|
| Japanese | ISO 2022 IR 13  |
| Thai     | ISO 2022 IR 166 |
| Japanese | ISO 2022 IR 87  |
| Japanese | ISO 2022 IR 159 |
| Korean   | ISO 2022 IR 149 |

### **D.6.3 CHARACTER SET CONFIGURATION**

Whether or not characters are displayed correctly depends on the presence of font support in the underlying operating system. Typically, as described in the Release Notes, it may be necessary for the user to add one of the “all Unicode” fonts to their system configuration in order to correctly display characters that would not typically be used in the default locale.



## **D.7 SECURITY**

### **D.7.1 SECURITY PROFILES**

None supported.

### **D.7.2 ASSOCIATION LEVEL SECURITY**

None supported.

Any Calling AE Titles and/or IP addresses may open an Association.

### **D.7.3 APPLICATION LEVEL SECURITY**

None supported.

## **D.8 ANNEXES**

### **D.8.1 IOD CONTENTS**

#### **D.8.1.1 Created SOP Instances**

None.

#### **D.8.1.2 Usage of attributes from received IOD's**

No SOP Class specific fields are required.

The local database, remote query and directory browsers make use of the conventional identification attributes to distinguish patients, studies, series and instances. In particular, if two patients have the same value for Patient ID, they will be treated as the same in the browser and the local database.

#### **D.8.1.3 Attribute Mapping**

Not applicable.

#### **D.8.1.4 Coerced/Modified fields**

No coercion is performed.

### **D.8.2 DATA DICTIONARY OF PRIVATE ATTRIBUTES**

No private attributes are defined.

### **D.8.3 CODED TERMINOLOGY AND TEMPLATES**

The value for Code Meaning will be displayed for all code sequences. No local lexicon is provided to look up alternative code meanings.

### **D.8.4 GRAYSCALE IMAGE CONSISTENCY**

The high resolution display monitor attached to the product can be calibrated according to the Grayscale Standard Display Function (GSDF). The Service/Installation Tool is used together with a luminance meter to measure the Characteristic Curve of the display system and the current ambient light. See the product Service Manual for details on the calibration procedure and supported calibration hardware. The result of the calibration procedure is a Monitor Correction LUT that will be active within the display subsystem after a system reboot.

### **D.8.6 STANDARD EXTENDED/SPECIALIZED/PRIVATE SOP CLASSES**

None

### **D.8.6 PRIVATE TRANSFER SYNTAXES**

None.

**ANNEX E (Informative) CONFORMANCE STATEMENT  
EXAMPLE-PRINT SERVER**

Disclaimer:

This document is a sample DICOM Conformance Statement for a fictional Print Server (SCP) Management System, called EXAMPLE-PRINT-SERVER-MANAGEMENT (also called Print Server) produced by a fictional vendor called EXAMPLE-IMAGING-PRODUCTS.

As stated in the annex title, this document is truly informative, and not normative. A conformance statement of an actual product might implement additional services and options as appropriate for its specific purpose. In addition, an actual product might implement the services described in a different manner and, for example, with different characteristics and/or sequencing of activities. In other words, this conformance statement example does not intend to standardize a particular manner that a product might implement DICOM functionality.

**E.0 COVER PAGE**

Company Name: EXAMPLE-PrintingPRODUCTS.

Product Name: EXAMPLE-PRINT-SERVER

Version: 1.0-rev. A.1

Internal document number: 4226-xxx-yyy-zzz rev 1

Date: YYYYMMDD

## E.1 CONFORMANCE STATEMENT OVERVIEW

This fictional product EXAMPLE-PRINT-SERVER-MANAGEMENT implements the necessary DICOM services to facilitate the Print (SCP) Imaging Management in the healthcare departments, managing Print imaging over a network on Medical Laser Imaging Systems. It enables the capabilities to capture images at any networked DICOM modality and then print them anywhere they're needed in the medical facility.

Furthermore, before sending the images to be printed the EXAMPLE-PRINT-SERVER-MANAGEMENT will apply image processing, using presentation parameters and LUT to improve the image presentation quality and consistency. Moreover, it will manage the printing presentation format and the Printer queue and Configuration.

Table E.1-1 provides an overview of the network services supported by EXAMPLE-PRINT-SERVER-MANAGEMENT.

**Table E.1-1  
NETWORK SERVICES**

| <b>SOP Classes</b>              | <b>User of Service (SCU)</b> | <b>Provider of Service (SCP)</b> |
|---------------------------------|------------------------------|----------------------------------|
| <b>Print Management</b>         |                              |                                  |
| Grayscale Print Management Meta | No                           | Yes                              |
| Presentation LUT                | No                           | Yes                              |
| Printer Configuration           | No                           | Yes                              |
| Print Job                       | No                           | Yes                              |
| Basic Annotation                | No                           | Yes                              |

## **E.2 TABLE OF CONTENTS**

A table of contents shall be provided to assist readers in easily finding the needed information.

## E.3 INTRODUCTION

### E.3.1 REVISION HISTORY

| Document Version | Date            | Author | Description          |
|------------------|-----------------|--------|----------------------|
| 1.1              | October 30,2003 | WG 6   | For Final Text       |
| 1.2              | August 30, 2007 | WG 6   | Revised Introduction |

### E.3.2 AUDIENCE, REMARKS, TERMS AND DEFINITIONS, BASICS OF DICOM COMMUNICATION, ABBREVIATIONS, REFERENCES

*See example text in Annex A.3.*

### E.3.3 ADDITIONAL REMARKS FOR THIS EXAMPLE

This document is a sample DICOM Conformance Statement created for DICOM PS3.2. It is to be used solely as an example to illustrate how to create a DICOM Conformance Statement for a print server system supporting DICOM Print Services. The subject of the document, EXAMPLE-PRINT-SERVER-MANAGEMENT, is a fictional product.

## E.4 NETWORKING

### E.4.1 IMPLEMENTATION MODEL

#### E.4.1.1 Application Data Flow

This implementation model uses the DICOM Basic Print Management Meta SOP Class to receive studies for the Medical Imager. Multiple associations to Print SCUs are supported.

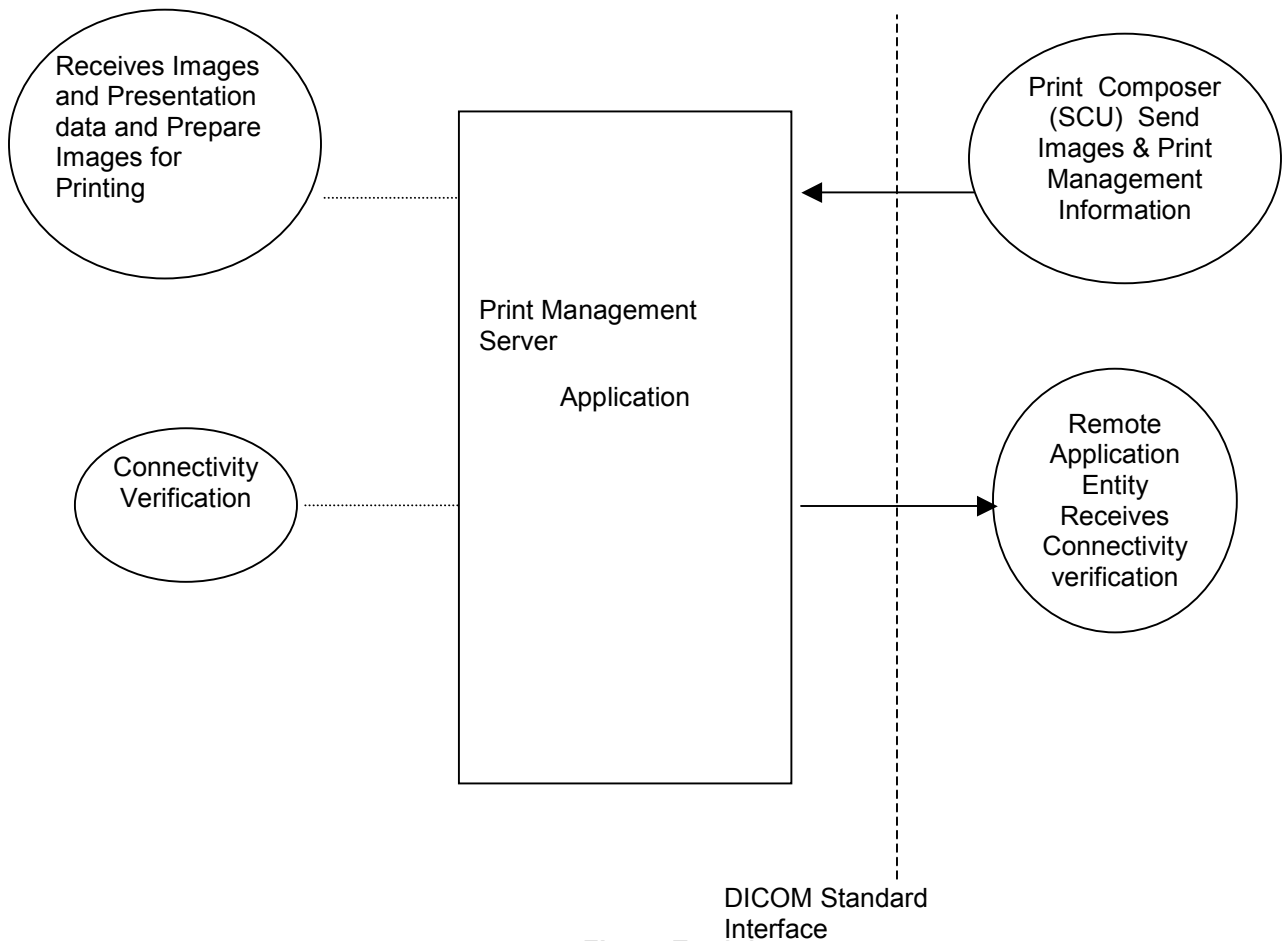


Figure E.4.1-1  
**APPLICATION DATA FLOW DIAGRAM**

The Print Server is receiving the Images with the Presentation and Annotation information, it Apply it on the images and creates a print-job within the print queue, containing one or more film pages composed from images selected by the client Print SCU. Furthermore, it also manages the Printer Status and Configuration.

#### E4.1.2 Functional Definition of AEs

##### E.4.1.2.1 Functional Definition of Print Server (SCP) Application Entity

The Print Server System acquires the images with the demographics and presentation information from the connected Print Composer (SCU) that is Grouped with a Workstation or an Archive device. Studies



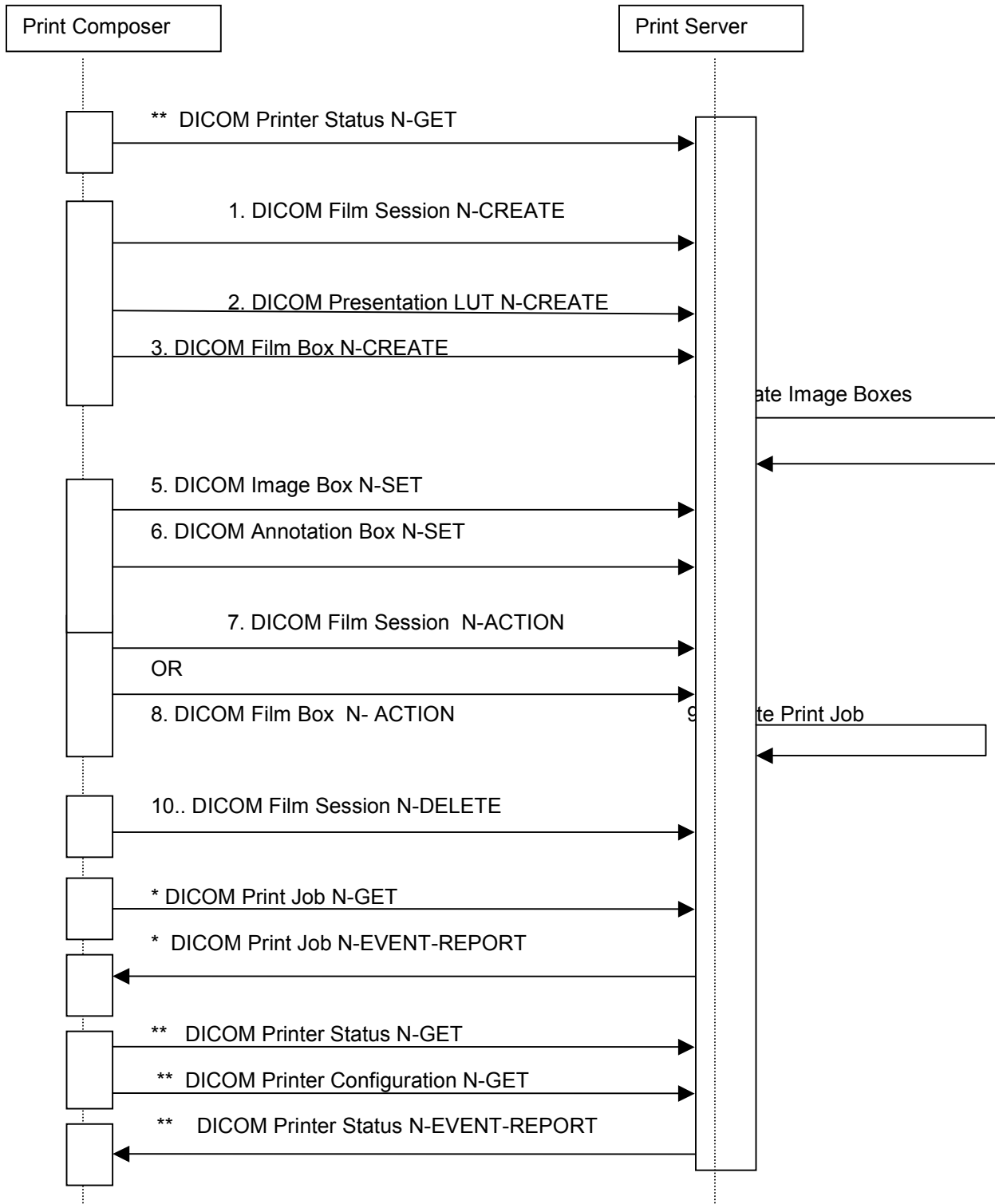
are temporarily stored on disk. The images are then processed and formatted and finally queued as a print job on the Printer queue. If the Printer is operating normally, then the film sheets described in the print-job will be printed. Changes in the Printer operation status will be detected (e.g. film Magazine empty) and reported back to the Print SCU. If the Printer is not operating normally, then the print-job will be set to an error state and can be restarted by the user via the job control interface.

The Print Server Management includes:

- DICOM Association and Negotiation Management
- Image Buffering
- Image Processing (Windowing level, P-LUT, GSDF, Annotation, etc)
- Image Formatting (Film sheet format)
- Printing
- Print Job Status Tracking
- Print Status Tracking
- Printer Configuration Tracking

The Printer Status and Configuration can be requested at any time by the Print SCU, while the Print Server will update the Print SCU asynchronously whenever the Printer status get changed. Furthermore, the Print Server provides in addition a Service operation of checking the networking connectivity to it's Print SCU using the Verification SOP Class.

**E.4.1.3 Sequencing of Real-World Activities**



### Figure E.4.1-2 PRINT SERVER MANAGEMENT SEQUENCE

- Notes:
1. The Print Job N-GET and N-EVENT-REPORT are Asynchronous messages that may occur at any time after the Print Job was created.
  2. The Printer Status & Configuration N-GET and the N-EVENT-REPORT are Asynchronous messages that may occur at any time it is needed during the Print sequence.

The Print Server Management workflow activities in the sequence order as described in Figure E.4.1-2 apply:

1. DICOM Film Session N-CREATE
2. DICOM Presentation LUT N-CREATE
3. DICOM Film Box N-CREATE
4. Create Image Boxes & Annotation Boxes
5. DICOM Image Box N-SET
6. DICOM Annotation Box N-SET
7. DICOM Film Session N-ACTION, A print job is created for each Film Session N-action.
8. DICOM Film Box N-ACTION, A print job is created for each Film Box N-action.
9. Create Print Job
10. DICOM Film Session N-DELETE.

The following additional activities are asynchronous mode and they can be send any time the Print Server is up and running:

- \* DICOM Print Job N-GET, request the execution status of a Print Job.
- \* DICOM Print Job N-EVENT-REPORT, report an update on the execution status of a Print Job.
- \*\* DICOM Printer Status N-GET – Request a Printer Status, anytime the Printer is ON.
- \*\* DICOM Printer Configuration N-GET - Request the Printer configuration, anytime the Printer is ON.
- \*\* DICOM Printer Status N-EVENT-REPORT – Report the Printer Status Changed.

**E.4.2 AE SPECIFICATIONS**

**E.4.2.1 Print Server Management (SCP) Application Entity Specification**

**E.4.2.1.1 SOP Classes**

The EXAMPLE-PRINT-SERVER-MANAGEMENT provides Standard Conformance to the following SOP Classes:

**Table E.4.2-1  
SOP CLASSES FOR AE PRINT SERVER (SCP)**

| SOP Class Name                                  | SOP Class UID              | SCU | SCP |
|-------------------------------------------------|----------------------------|-----|-----|
| Basic Grayscale Print Management Meta SOP Class | 1.2.840.10008.5.1.1.9      | No  | Yes |
| Presentation LUT SOP Class                      | 1.2.840.10008.5.1.1.23     | No  | Yes |
| Printer Configuration                           | 1.2.840.10008.5.1.1.16.376 | No  | Yes |
| Print Job                                       | 1.2.840.10008.5.1.1.14     | No  | Yes |
| Basic Annotation Box SOP Class                  | 1.2.840.10008.5.1.1.15     | No  | Yes |
| Verification SOP Class                          | 1.2.840.10008.1.1          | Yes | Yes |

**E.4.2.1.2 Association Establishment Policy**

**E.4.2.1.2.1 General**

The Print Server Management System will accept associations while configured as an Print SCP and while a valid local Printer destination exists.

The DICOM standard application context name for DICOM 3.0 is always accepted

**Table E.4.2-2  
DICOM APPLICATION CONTEXT FOR AE PRINT SCP**

|                          |                       |
|--------------------------|-----------------------|
| Application Context Name | 1.2.840.10008.3.1.1.1 |
|--------------------------|-----------------------|

**E.4.2.1.2.2 Number of Associations**

The EXAMPLE-PRINT-SERVER-MANAGEMENT will accept Up to 8 simultaneous delivery Associations. If an attempt is made to open more than 8 simultaneous Associations, the Print Server System will reject the additional Associations (A-ASSOCIATE-RJ).

**Table E.4.2-3  
NUMBER OF ASSOCIATIONS ACCEPTED FOR AE PRINT SERVER MANAGEMENT (SCP)**

|                                             |                     |
|---------------------------------------------|---------------------|
| Maximum number of simultaneous Associations | 8<br>(Configurable) |
|---------------------------------------------|---------------------|

EXAMPLE-PRINT-SERVER-MANAGEMENT will also initiate one Association at a time for each destination to which a connectivity verification request is being processed. Only one connectivity verification job will be active at a time, the other remains pending until the active job is completed or failed.

**Table E.4.2-4  
NUMBER OF ASSOCIATIONS INITIATED FOR CONNECTIVITY**

|                                             |   |
|---------------------------------------------|---|
| Maximum number of simultaneous Associations | 1 |
|---------------------------------------------|---|

**E.4.2.1.2.3 Asynchronous Nature**

The EXAMPLE-PRINT-SERVER-MANAGEMENT does not support asynchronous communication. Multiple outstanding transactions are not supported. It allows up to one invoked and one performed operation on an Association (it is synchronous).

**Table E.4.2-5  
ASYNCHRONOUS NATURE AS A SCP FOR AE PRINT SERVER (SCP)**

|                                                         |   |
|---------------------------------------------------------|---|
| Maximum number of outstanding asynchronous transactions | 1 |
|---------------------------------------------------------|---|

**E.4.2.1.2.4 Implementation Identifying Information**

The implementation information for this Application Entity is:

**Table E.4.2-6  
DICOM IMPLEMENTATION CLASS AND VERSION FOR AE PRINT SCP**

|                             |                               |
|-----------------------------|-------------------------------|
| Implementation Class UID    | xxxxxxxxxxx.yy.etc.ad.inf.usw |
| Implementation Version Name | PRINTSCP_VERS_01              |

**E.4.2.1.3 Association Initiation Policy**

**E.4.2.1.3.1 Activity – Connectivity Verification**

**E.4.2.1.3.1.1 Description and Sequencing of Activities**

The EXAMPLE-PRINT-SERVER-MANAGEMENT initiates Associations only for the purpose of verifying a DICOM connection.

**E.4.2.1.3.1.2 Proposed Presentation Context Table**

The EXAMPLE-PRINT-SERVER-MANAGEMENT is capable of proposing the Presentation Contexts as shown in the following table:

**Table E.4.2-7  
PROPOSED PRESENTATION CONTEXT FOR CONNECTIVITY VERIFICATION**

| Presentation Context Table |                   |                                                        |                                          |      |            |
|----------------------------|-------------------|--------------------------------------------------------|------------------------------------------|------|------------|
| Abstract Syntax            |                   | Transfer Syntax                                        |                                          | Role | Ext. Negot |
| Name                       | UID               | Name List                                              | UID List                                 |      |            |
| Verification               | 1.2.840.10008.1.1 | Implicit VR Little Endian<br>Explicit VR Little Endian | 1.2.840.10008.1.2<br>1.2.840.10008.1.2.1 | SCU  | None       |

**E.4.2.1.3.1.3 SOP Specific Conformance for Connectivity Verification**

The EXAMPLE-PRINT-SERVER-MANAGEMENT provides standard conformance to the DICOM Verification Service Class as an SCU. The status code for the C-ECHO is as follows:

- Standard -

**Table E.4.2-8  
C-ECHO RESPONSE STATUS HANDLING BEHAVIOUR**

| Code | Status  | Meaning                         |
|------|---------|---------------------------------|
| 0000 | Success | The C-ECHO request is accepted. |

**E.4.2.1.4 Association Acceptance Policy**

**E.4.2.1.4.1 Activity – Print Server Management**

**E.4.2.1.4.1.1 Description and Sequencing of Activities**

A remote peer DICOM Application Entity, acting as an Print SCU, establishes an association with the EXAMPLE-PRINT-SERVER-MANAGEMENT that accepts these Associations for the purpose of receiving images and image presentation related data for image processing and printing on a hard copy medium.

When an association has been established the Sequencing of Real-World Activities is as described in section 4.1.3.

The Print Server (SCP) AE may reject association attempts as shown in Table E.4.2-9. The Result, Source and Reason/Diag columns represent the values returned in the appropriate fields of an ASSOCIATE-RJ PDU (see PS 3.8, Section 9.3.4). The contents of the Source column is abbreviated to save space and the meaning of the abbreviations are:

- a – DICOM UL service-user
- b – DICOM UL service-provider (ASCE related function)
- c – DICOM UL service-provider (Presentation related function)

**Table E.4.2-9  
ASSOCIATION REJECTION REASONS**

| Result                 | Source | Reason/Diag                                | Explanation                                                                                                                                                                                                                                                                                                                                                          |
|------------------------|--------|--------------------------------------------|----------------------------------------------------------------------------------------------------------------------------------------------------------------------------------------------------------------------------------------------------------------------------------------------------------------------------------------------------------------------|
| 2 – rejected-transient | c      | 2 – local-limit-exceeded                   | The (configurable) maximum number of simultaneous associations has been reached. An association request with the same parameters may succeed at a later time.                                                                                                                                                                                                        |
| 2 – rejected-transient | c      | 1 – temporary-congestion                   | No associations can be accepted at this time due to the real-time requirements of higher priority activities (e.g. during image acquisition no associations will be accepted) or because insufficient resources are available (e.g. memory, processes, threads). An association request with the same parameters may succeed at a later time.                        |
| 1 – rejected-permanent | a      | 2 – application-context-name-not-supported | The association request contained an unsupported Application Context Name. An association request with the same parameters will not succeed at a later time.                                                                                                                                                                                                         |
| 1 – rejected-permanent | a      | 7 – called-AE-title-not-recognized         | The association request contained an unrecognized Called AE Title. An association request with the same parameters will not succeed at a later time unless configuration changes are made. This rejection reason normally occurs when the association initiator is incorrectly configured and attempts to address the association acceptor using the wrong AE Title. |
| 1 – rejected-permanent | a      | 3 – calling-AE-title-not-recognized        | The association request contained an unrecognized Calling AE Title. An association request with the same parameters will not succeed at a later time unless configuration changes are made. This rejection reason                                                                                                                                                    |

|                        |   |                     |                                                                                                                               |
|------------------------|---|---------------------|-------------------------------------------------------------------------------------------------------------------------------|
|                        |   |                     | normally occurs when the association acceptor has not been configured to recognize the AE Title of the association initiator. |
| 1 – rejected-permanent | b | 1 – no-reason-given | The association request could not be parsed. An association request with the same format will not succeed at a later time.    |

#### E.4.2.1.4.1.2 Accepted Presentation Contexts

EXAMPLE-PRINT-SERVER-MANAGEMENT will accept Presentation Contexts as shown in the following table:

**Table E.4.2-10  
ACCEPTED PRESENTATION CONTEXTS FOR PRINT SERVER MANAGEMENT ACTIVITY**

| Presentation Context Table                |                            |                                                        |                                          |      |                      |
|-------------------------------------------|----------------------------|--------------------------------------------------------|------------------------------------------|------|----------------------|
| Abstract Syntax                           |                            | Transfer Syntax                                        |                                          | Role | Extended Negotiation |
| Name                                      | UID                        | Name List                                              | UID List                                 |      |                      |
| Verification                              | 1.2.840.10008.1.1          | Implicit VR Little Endian<br>Explicit VR Little Endian | 1.2.840.10008.1.2<br>1.2.840.10008.1.2.1 | SCP  | None                 |
| Basic Grayscale Print Management Meta SOP | 1.2.840.10008.5.1.1.9      | Implicit VR Little Endian<br>Explicit VR Little Endian | 1.2.840.10008.1.2<br>1.2.840.10008.1.2.1 | SCP  | None                 |
| Basic Annotation Box                      | 1.2.840.10008.5.1.1.15     | Implicit VR Little Endian<br>Explicit VR Little Endian | 1.2.840.10008.1.2<br>1.2.840.10008.1.2.1 | SCP  | None                 |
| Print Job                                 | 1.2.840.10008.5.1.1.14     | Implicit VR Little Endian<br>Explicit VR Little Endian | 1.2.840.10008.1.2<br>1.2.840.10008.1.2.1 | SCP  | None                 |
| Presentation LUT                          | 1.2.840.10008.5.1.1.23     | Implicit VR Little Endian<br>Explicit VR Little Endian | 1.2.840.10008.1.2<br>1.2.840.10008.1.2.1 | SCP  | None                 |
| Printer Configuration                     | 1.2.840.10008.5.1.1.16.376 | Implicit VR Little Endian<br>Explicit VR Little Endian | 1.2.840.10008.1.2<br>1.2.840.10008.1.2.1 | SCP  | None                 |

The Print Server Management AE will prefer to accept the Explicit VR Little Endian Transfer Syntax if multiple transfer syntaxes are offered. Furthermore, At the time of association establishment, the Print Server Management confirms, returning a list of presentation contexts that were proposed by the Print SCU and that will be supported by the Print Server Management.

**E.4.2.1.4.1.3 SOP Specific Conformance**

**E.4.2.1.4.1.3.1 Specific Conformance for Verification SOP Class**

The EXAMPLE-PRINT-SERVER-MANAGEMENT provides standard conformance to the DICOM Verification Service Class as a SCP. The status code for the C-ECHO is in the following table:

**Table E.4.2-11  
C-ECHO RESPONSE STATUS HANDLING REASONS**

| Code | Status  | Reason                          |
|------|---------|---------------------------------|
| 0000 | Success | The C-ECHO request is accepted. |

**E.4.2.1.4.1.3.2 Specific Conformance to Grayscale Print Management Meta SOP Class**

The EXAMPLE-PRINT-SERVER-MANAGEMENT supports the following mandatory SOP classes as defined by the Basic Grayscale Print Management Meta SOP Class:

**Table E.4.2-12  
SOP CLASSES FOR BASIC GRAYSCALE PRINT MANAGEMENT META SOP CLASS**

| SOP Class Name            | SOP Class UID          | SCU | SCP |
|---------------------------|------------------------|-----|-----|
| Basic Film Session        | 1.2.840.10008.5.1.1.1  | No  | Yes |
| Basic Film Box            | 1.2.840.10008.5.1.1.2  | No  | Yes |
| Basic Grayscale Image Box | 1.2.840.10008.5.1.1.4  | No  | Yes |
| Printer                   | 1.2.840.10008.5.1.1.16 | No  | Yes |

The Common SOP Specific Conformance for all Print SOP Classes, including the general behavior of Print Server Management AE during communication failure is summarized in the following table:

**Table E.4.2-13  
PRINT SERVER SCP COMMUNICATION FAILURE REASONS**

| Exception                                        | Behavior                                                                                                                                                                          |
|--------------------------------------------------|-----------------------------------------------------------------------------------------------------------------------------------------------------------------------------------|
| Timeout                                          | The Association is aborted using A-ABORT and the print-job is marked as failed. The reason is logged and the job failure is reported to the user via the job control application. |
| Association aborted by the SCP or network layers | The print-job is marked as failed. The reason is logged and the job failure is reported to the user via the job control application.                                              |

The specific SOP Conformance statement for each of the Basic Grayscale Print Management Meta SOP Class components is described in the subsequent sections.

**E.4.2.1.4.1.3.2.1 Specific Conformance for Basic Film Session SOP Class**

The EXAMPLE-PRINT-SERVER-MANAGEMENT provides support for the following DIMSE Services:

— N-CREATE



- N-SET
- N-ACTION
- N-DELETE

**E.4.2.1.4.1.3.2.1.1 Film Session SOP Class Operations for N-CREATE**

The EXAMPLE-PRINT-SERVER-MANAGEMENT provides the following support for the Film Session attributes sent by the N-CREATE DIMSE service::

**Table E.4.2-14  
BASIC FILM SESSION SOP CLASS N-CREATE REQUEST ATTRIBUTES**

| Attribute          | Tag         | Valid Range                                                     | Default Value if not sent by SCU or invalid value received | Response to Invalid Value |
|--------------------|-------------|-----------------------------------------------------------------|------------------------------------------------------------|---------------------------|
| Number of Copies   | (2000,0010) | 1 – 99                                                          | 1                                                          | Warning (0x116)           |
| Print Priority     | (2000,0020) | LOW<br>MED<br>HIGH                                              | LOW                                                        | Warning (0x116)           |
| Medium Type        | (2000,0030) | CLEAR FILM<br>BLUE FILM<br>PAPER<br>CURRENT (See section 8.8.1) | CLEAR FILM                                                 | Warning (0x116)           |
| Film Destination   | (2000,0040) | MAGAZINE<br>PROCESSOR<br>CURRENT (See section 8.8.1)            | MAGAZINE                                                   | Warning (0x116)           |
| Film Session Label | (2000,0050) | Up to 64 characters                                             | No default.                                                | Warning (0x116)           |

The Print Server Management behavior and specific status codes sent for the N-CREATE of a specific Film Session is described in the following table:

**Table E.4.2-15  
FILM SESSION SOP CLASS N-CREATE RESPONSE STATUS HANDLING REASONS**

| Service Status | Further Meaning              | Error Code | Reason                                                                                                                                                                                                                                  |
|----------------|------------------------------|------------|-----------------------------------------------------------------------------------------------------------------------------------------------------------------------------------------------------------------------------------------|
| Success        | Success                      | 0000       | The SCP has completed the operation successfully.                                                                                                                                                                                       |
| Warning        | Attribute Value Out of Range | 0116       | The N-CREATE operation is considered successful but the status meaning is logged. Additional information in the Response identifying the attributes out of range will be logged (i.e. Elements in the Modification List/Attribute List) |
| Warning        | Memory allocation not        | B600       | A data set is returned with valid attributes/values.                                                                                                                                                                                    |

|         |                         |      |                                                                                                                                                                                                                     |
|---------|-------------------------|------|---------------------------------------------------------------------------------------------------------------------------------------------------------------------------------------------------------------------|
|         | supported               |      |                                                                                                                                                                                                                     |
| Warning | Attribute List Error    | 0107 | The N-CREATE operation is considered successful but the status meaning is logged. Additional information in the Response identifying the attributes will be logged (i.e. Elements in the Attribute Identifier List) |
| Failure | Invalid attribute value | 0106 | A data set is returned of all invalid attributes/values                                                                                                                                                             |
| Failure | Processing failure      | 0110 | Cannot decode the DIMSE attribute.                                                                                                                                                                                  |
| Failure | Invalid object instance | 0117 | Instance UID given had incorrect syntax                                                                                                                                                                             |
| Failure | Resource limitation     | 0213 | Film Session cannot be opened.                                                                                                                                                                                      |

**E.4.2.1.4.1.3.2.1.2 Film Session SOP Class Operations for N-SET**

The EXAMPLE-PRINT-SERVER-MANAGEMENT provides the support for the Film Session attributes sent by the N-SET DIMSE service identically as it is described for the Film Session with N-CREATE, table E.4.2-15.

The Print Server Management behavior and specific status codes sent for the N-SET of a specific Film Session is described in the following table:

**Table E.4.2-16  
FILM SESSION SOP CLASS N-SET RESPONSE STATUS HANDLING REASONS**

| <b>Service Status</b> | <b>Further Meaning</b>          | <b>Error Code</b> | <b>Reason</b>                                                                                                                                                                                                       |
|-----------------------|---------------------------------|-------------------|---------------------------------------------------------------------------------------------------------------------------------------------------------------------------------------------------------------------|
| Success               | Success                         | 0000              | The SCP has completed the operation successfully. Some attributes may have different values than what was requested. The actual values of attributes are returned.                                                  |
| Warning               | Attribute Value Out of Range    | 0116              | The attribute in question are returned in the responses data set.                                                                                                                                                   |
| Warning               | Attribute List Error            | 0107              | The N-CREATE operation is considered successful but the status meaning is logged. Additional information in the Response identifying the attributes will be logged (i.e. Elements in the Attribute Identifier List) |
| Warning               | Memory allocation not supported | B600              | .A data set is returned with valid attributes/values.                                                                                                                                                               |
| Failure               | Invalid attribute value         | 0106              | A data set is returned of all invalid attributes/values                                                                                                                                                             |
| Failure               | Processing failure              | 0110              | Cannot decode the DIMSE attribute.                                                                                                                                                                                  |
| Failure               | Invalid object instance         | 0112              | No such object instance: the instance UID given does not exist.                                                                                                                                                     |

**E.4.2.1.4.1.3.2.1.3 Film Session SOP Class Operations for N-DELETE**

The Print Server Management behavior and specific status codes sent for the N-DELETE of a specific Film Session is described in the following table:

**Table E.4.2-17  
FILM SESSION SOP CLASS N-DELETE RESPONSE STATUS HANDLING REASONS**

| <b>Service Status</b> | <b>Further Meaning</b> | <b>Error Code</b> | <b>Reason</b>                                                                                                                                                                                             |
|-----------------------|------------------------|-------------------|-----------------------------------------------------------------------------------------------------------------------------------------------------------------------------------------------------------|
| Success               | Success                | 0000              | The SCP has completed the operation successfully. Film session has been successfully deleted.                                                                                                             |
| Failure               | Unknown UID            | 0112              | No such object instance: the instance UID given does not exist.<br>The Association is aborted using A-ABORT and the print-job is marked as failed. The status meaning is logged and reported to the user. |

**E.4.2.1.4.1.3.2.1.4 Film Session SOP Class Operations for N-ACTION**

The receipt of the N-ACTION will result in submitting a print job to print all the films of the film session in the order that they were received. The Film Session N-ACTION arguments are defined in the DICOM Standard PS 3.4, table H.4-3. The number of films that can be stored for print is limited by the size of the Printer's installed disk space and the number of images sent by the connected Print SCU simultaneously.

The Print Server Management behavior and specific status codes sent for the N-ACTION of a specific Film Session is described in the following table:

**Table E.4.2-18  
Film Session SOP Class N-ACTION Response Status Handling Reasons**

| <b>Service Status</b> | <b>Further Meaning</b>      | <b>Error Code</b> | <b>Reason</b>                                                                                                               |
|-----------------------|-----------------------------|-------------------|-----------------------------------------------------------------------------------------------------------------------------|
| Success               | Success                     | 0000              | Films in the film session are accepted for printing.<br>Print Job SOP instance is created and the instance UID is returned. |
| Warning               | Empty film page             | B602              | Film Session SOP instance hierarchy does not contain Image Box SOP instances (empty page). Empty page will not be printed.  |
| Warning               | Image larger than Image Box | B604              | Image size is larger than Image Box size. Image has been de-magnified                                                       |
| Warning               | Image larger than Image Box | B609              | Image size is larger than Image Box size. Image has been clipped to fit it                                                  |
| Warning               | Image larger than Image Box | B60A              | Image size is larger than Image Box size. Image has been decimated to fit it.                                               |
| Failure               | Invalid object              | 0112              | No such object instance: the instance UID given does not exist.                                                             |
| Failure               | Invalid operation           | 0211              | The action ID type is not supported (i.e., not PRINT).                                                                      |
| Failure               | Processing failure          | C600              | Film Session SOP instance hierarchy does not contain Film Box SOP instances.                                                |

|         |                        |      |                                                                                     |
|---------|------------------------|------|-------------------------------------------------------------------------------------|
| Failure | OUT of Resources       | C601 | Unable to create Print Job SOP instance; print queue is full..                      |
| Failure | Wrong Image size       | C603 | Image size is larger then Image Box size. The image will not be printed.            |
| Failure | Wrong Print Image size | C613 | Print Image size is greater then the Image Box size. The image will not be printed. |

**E.4.2.1.4.1.3.2.2 Specific Conformance for Basic Film Box SOP Class**

The EXAMPLE-PRINT-SERVER-MANAGEMENT provides support for the following DIMSE Services:

- N-CREATE
- N-SET
- N-ACTION
- N-DELETE

**E.4.2.1.4.1.3.2.2.1 Basic Film Box SOP Class Operations for N-CREATE**

The EXAMPLE-PRINT-SERVER-MANAGEMENT provides the following support for the Film Box attributes sent by the N-CREATE DIMSE service

**Table E.4.2-19  
BASIC FILM BOX SOP CLASS N-CREATE REQUEST ATTRIBUTES**

| Attribute                        | Tag         | Valid Range                             | Default Value if not sent by SCU or invalid value received | Response to Invalid Value |
|----------------------------------|-------------|-----------------------------------------|------------------------------------------------------------|---------------------------|
| Image Display Format             | (2010,0010) | STANDARD\C,ROW\R1,R2,R3<br>COL\C1,C2,C3 | Configurable                                               | Failure (0x0106)          |
| Referenced Film Session Sequence | (2010,0500) | N/A                                     | N/A                                                        | N/A                       |
| > Referenced SOP Class UID       | (0008,1150) | SOP Class UID                           | Mandatory, no default                                      | Failure (0x0106)          |
| > Referenced SOP Instance UID    | (0008,1155) | SOP Instance UID                        | Mandatory, no default                                      | Failure (0x0106)          |
| Referenced Image Box Sequence    | (2010,0510) | N/A                                     | N/A                                                        | N/A                       |
| > Referenced SOP Class UID       | (0008,1150) | SOP Class UID                           | Mandatory, no default                                      | Failure (0x0106)          |

|                                            |             |                                                  |                                                     |                  |
|--------------------------------------------|-------------|--------------------------------------------------|-----------------------------------------------------|------------------|
| > Referenced SOP Instance UID              | (0008,1155) | SOP Instance UID                                 | Mandatory, no default                               | Failure (0x0106) |
| Film Orientation                           | (2010,0040) | PORTRAIT<br>LANDSCAPE                            | PORTRAIT                                            | Warning (0x116)  |
| Film Size Id<br>see Note 1                 | (2010,0050) | 8INX10IN<br>11INX14IN<br>14INX17IN<br>CURRENT    | 14INX17IN                                           | Warning (0x116)  |
| Magnification Type                         | (2010,0060) | REPLICATE<br>BILINEAR<br>CUBIC<br>NONE           | Configurable                                        | Warning (0x116)  |
| Max Density                                | (2010,0130) | 170-350                                          | 320                                                 | Warning (0x116)  |
| Annotation Display<br>Format Id see note 2 | (2010,0030) | LABEL<br>BOTTOM<br>COMBINED<br>NONE              | NONE                                                | Warning (0x116)  |
| Smoothing Type<br>See note 3               | (2010,0080) | 0-15, the value is laser specific.               | Configurable                                        | Warning (0x116)  |
| Border Density<br>See note 4               | (2010,0100) | WHITE<br>BLACK                                   | BLACK                                               | Warning (0x116)  |
| Trim<br>See note 5                         | (2010,0140) | YES<br>NO                                        | NO                                                  | Warning (0x116)  |
| Reference Presentation LUT Sequence        | (2050,0500) | N/A                                              | N/A                                                 | N/A              |
| >Referenced SOP Class UID                  | (0008,1150) | SOP Class UID                                    | Mandatory if sequence is present, no default        | Failure (0x0106) |
| >Referenced SOP Instance UID               | (0008,1155) | SOP Instance UID                                 | Mandatory if sequence is present, no default        | Failure (0x0106) |
| Illumination                               | (2010,015E) | Any valid value in the unit of cd/m <sup>2</sup> | 2000,<br>Mandatory if Presentation LUT is supported | Warning (0x116)  |
| Reflective Ambient Light                   | (2010,0160) | Any valid value in the unit of cd/m <sup>2</sup> | 10,<br>Mandatory if Presentation LUT is supported   | Warning (0x116)  |

Note 1: See the addition value "CURRENT" in section E.8.8.1

Note 2: Annotation Display Format Id1 - instructs the Print Server Management System to create annotation boxes and set the format of the annotation boxes. The currently loaded machine resident font will be used. See table below.

Note 3: Smoothing Type - If Magnification Type is CUBIC, this attribute allows the SCU to specify the various smoothing effects provided by the interpolation algorithm in the Laser Imager. 0 specifies replicate, and 1 through 15 specifies various levels of smoothing.

Note 4: Border Density - allows the density of the areas surrounding and between images on the film to be either dark or white.

Note 5: Trim - specifies whether a trim box be printed around each image on film. The trim density is the opposite of the border density.

The following table describes the annotation formats are supported:

**Table E.4.2-20  
ANNOTATION DISPLAY FORMATS**

| <b>Annotation Display Format Id</b> | <b>Format</b>                                                                                                                                                                                                                                                                                                                                                   |
|-------------------------------------|-----------------------------------------------------------------------------------------------------------------------------------------------------------------------------------------------------------------------------------------------------------------------------------------------------------------------------------------------------------------|
| LABEL                               | Prints a text string at the top of the film as a label. One Annotation Box is created. The Annotation Position for this box must be 0.                                                                                                                                                                                                                          |
| BOTTOM                              | Prints a text string at the bottom of each image. The number of Annotation Boxes created will be equal to the number of images supported by the Image Display Format. The Annotation Position for each annotation string should be the same as the corresponding Image Position.                                                                                |
| COMBINED                            | Combines the above two annotation formats: Prints a text string at the bottom of each image (with Annotation Position matching the corresponding Image Position), and a label at the top of the film (its Annotation Position = 0). The number of Annotation Boxes created will be one greater than the number of images supported by the Image Display Format. |
| NONE                                | No text string is printed at the top of the film or at the bottom of each image.                                                                                                                                                                                                                                                                                |

The Print Server Management behavior and specific status codes sent for the N-CREATE of a specific Film Box is described in the following table:

**Table E.4.2-21  
FILM BOX SOP CLASS N-CREATE RESPONSE STATUS HANDLING BEHAVIOR**

| <b>Service Status</b> | <b>Further Meaning</b> | <b>Error Code</b> | <b>Behavior</b>                                                                                                           |
|-----------------------|------------------------|-------------------|---------------------------------------------------------------------------------------------------------------------------|
|                       |                        |                   | Film box is successfully created. Some attributes may have different values than what was requested. The actual values of |

|         |                              |      |                                                                                                                                                                                                                                                                   |
|---------|------------------------------|------|-------------------------------------------------------------------------------------------------------------------------------------------------------------------------------------------------------------------------------------------------------------------|
| Success | Success                      | 0000 | attributes are returned.<br>Note that any existing film box will become inaccessible when a new film box is successfully created. Failure will be returned to the SCU if the SCU attempts to access (set image, erase image, delete, print) the previous film box |
| Warning | Attribute Value Out of Range | 0116 | With the exception of the referenced Film Session sequence, the referenced Image Box sequence and the possible referenced Annotation Box sequence, the attribute in question will be the only attribute returned in the responses data set.                       |
| Warning | Min/Max Density out-range    | B605 | Requested Min Density or Max Density outside of printer's operating range. The printer will use its respective minimum or maximum density value instead.                                                                                                          |
| Failure | Invalid attribute value      | 0106 | A data set is returned with all invalid attributes/values                                                                                                                                                                                                         |
| Failure | Processing failure           | 0110 | Cannot decode the DIMSE attribute                                                                                                                                                                                                                                 |
| Failure | Duplicate SOP instance       | 0111 | The given Instance UID is already in use.                                                                                                                                                                                                                         |
| Failure | Invalid object instance      | 0117 | The given Instance UID had incorrect syntax.                                                                                                                                                                                                                      |
| Failure | Missing attribute            | 0120 | Mandatory attributes are missing.<br>A list of missing mandatory attribute tags is returned in the Attribute Identifier List (0000,1005).                                                                                                                         |
| Failure | Missing attribute value      | 0121 | A mandatory attribute was given, but had no value.<br>A data set is returned of all attributes/values missing.                                                                                                                                                    |
| Failure | Resource limitation          | 0213 | Film Session cannot be opened.                                                                                                                                                                                                                                    |
| Failure | Out of Print Job Sequence    | C616 | There is an existing Film Box that has not been printed and the Film Session N-ACTION, is not supported. A new Film Box will not be created when a previous Film Box has not been printed.                                                                        |

**E.4.2.1.4.1.3.2.2.2 Basic Film Box SOP Class Operations for N-SET**

The EXAMPLE-PRINT-SERVER-MANAGEMENT provides the support for the following Film Box attributes sent by the N-SET DIMSE service:

**Table E.4.2-22  
BASIC FILM BOX SOP CLASS N-SET REQUEST ATTRIBUTES**

| <b>Attribute</b>   | <b>Tag</b>  | <b>Valid Range</b>    | <b>Default Value if not sent by SCU or invalid value received</b> | <b>Response to Invalid Value</b> |
|--------------------|-------------|-----------------------|-------------------------------------------------------------------|----------------------------------|
| Magnification Type | (2010,0060) | REPLICATE<br>BILINEAR | Configurable                                                      | Warning (0x116)                  |

|                                           |             |                                                                                                                                |                                                           |                  |
|-------------------------------------------|-------------|--------------------------------------------------------------------------------------------------------------------------------|-----------------------------------------------------------|------------------|
|                                           |             | CUBIC<br>NONE                                                                                                                  |                                                           |                  |
| Max Density                               | (2010,0130) | 170-350                                                                                                                        | 320                                                       | Warning (0x116)  |
| Smoothing Types<br>see Note 1             | (2010,0080) | 0-15, the value<br>is laser specific.                                                                                          | Configurable                                              | Warning (0x116)  |
| Border Density<br>see Note 2              | (2010,0100) | WHITE<br>BLACK                                                                                                                 | BLACK                                                     | Warning (0x116)  |
| Trim see Note 3                           | (2010,0140) | YES<br>NO                                                                                                                      | NO                                                        | Warning (0x116)  |
| Reference<br>Presentation LUT<br>Sequence | (2050,0500) | N/A                                                                                                                            | N/A                                                       | N/A              |
| >Referenced SOP<br>Class UID              | (0008,1150) | SOP Class UID                                                                                                                  | Mandatory if<br>sequence is<br>present, no default        | Failure (0x0106) |
| >Referenced SOP<br>Instance UID           | (0008,1155) | SOP Instance<br>UID                                                                                                            | Mandatory if<br>sequence is<br>present, no default        | Failure (0x0106) |
| Illumination                              | (2010,015E) | Any valid value<br>in the unit of<br>cd/m <sup>2</sup>                                                                         | 2000,<br>Mandatory if<br>Presentation LUT<br>is supported | Warning (0x116)  |
| Configuration<br>Information              | (2010,0150) | LUT = m,n<br>m = a<br>character string<br>or 0,<br>n = 0-15, the<br>value is laser<br>specific.<br>CSxxx<br>000 ≤ xxx ≤<br>015 | m = a character<br>string or 0,<br>n is configurable.     | Warning (0x116)  |
| Reflective<br>Ambient Light               | (2010,0160) | Any valid value<br>in the unit of<br>cd/m <sup>2</sup>                                                                         | 10,<br>Mandatory if<br>Presentation LUT<br>is supported   | Warning (0x116)  |

Note 1: Smoothing Type 2- If Magnification Type is CUBIC, this attribute allows the SCU to specify the various smoothing effects provided by the interpolation algorithm in the Laser Imager. 0 specifies replicate, and 1 through 15 specifies various levels of smoothing.

Note 2: Border Density 3- allows the density of the areas surrounding and between images on the film to be either dark or white.

Note 3: Trim4 - specifies whether a trim box be printed around each image on film. The trim density is the opposite of the border density.



The Print Server Management behavior and specific status codes sent for the N-SET of a specific Film Box is described in the following table:

**Table E.4.2-23  
FILM BOX SOP CLASS N-SET RESPONSE STATUS HANDLING BEHAVIOR**

| <b>Service Status</b> | <b>Further Meaning</b>  | <b>Error Code</b> | <b>Behavior</b>                                                                                                                                                                                                                                                                        |
|-----------------------|-------------------------|-------------------|----------------------------------------------------------------------------------------------------------------------------------------------------------------------------------------------------------------------------------------------------------------------------------------|
| Success               | Success                 | 0000              | Some attributes may have different values than what was requested. The actual values of attributes are returned.                                                                                                                                                                       |
| Warning               | Illegal Attribute       | 0107              | Attributes not recognized within the context of this SOP class. For example, an N-Set on the Image Display format attribute was attempted. A list of offending attribute tags is returned in Attribute List (0000,1005).<br>A data set is still returned with valid attributes/values. |
| Warning               | Attribute out of range  | 0116              | The attribute in question is the only attribute returned in the responses data set.                                                                                                                                                                                                    |
| Failure               | Invalid attribute value | 0106              | A data set is returned with all invalid attributes/values                                                                                                                                                                                                                              |
| Failure               | Processing failure      | 0110              | Cannot decode the DIMSE attribute                                                                                                                                                                                                                                                      |
| Failure               | No object instance      | 0112              | The given instance UID does not exist.                                                                                                                                                                                                                                                 |
| Failure               | Missing attribute value | 0121              | A mandatory attribute was given, but had no value.<br>A data set is returned of all attributes/values missing.                                                                                                                                                                         |

**E.4.2.1.4.1.3.2.2.3 Basic Film Box SOP Class Operations for N-DELETE**

The EXAMPLE-PRINT-SERVER-MANAGEMENT provides the support for deleting the last created Film Box.

The specific behavior and status codes sent for the N-DELETE of the last created Film Box is described in the following table:

**Table E.4.2-24  
FILM BOX SOP CLASS N-DELETE RESPONSE STATUS HANDLING BEHAVIOR**

| <b>Service Status</b> | <b>Further Meaning</b> | <b>Error Code</b> | <b>Behavior</b>                                                 |
|-----------------------|------------------------|-------------------|-----------------------------------------------------------------|
| Success               | Success                | 0000              | Film box has been successfully deleted.                         |
| Failure               | Illegal UID            | 0112              | No such object instance: the instance UID given does not exist. |

**E.4.2.1.4.1.3.2.2.4 Basic Film Box SOP Class Operations for N-Action**

The EXAMPLE-PRINT-SERVER-MANAGEMENT provides the support for submitting the print job for printing the specific Film Box. The Film BOX N-ACTION arguments are defined in the DICOM Standard PS 3.4, table H.4-8.

The specific behavior and status codes sent for the N-ACTION of the specific Film Box is described in the following table:

**Table E.4.2-25  
FILM BOX SOP CLASS N-ACTION RESPONSE STATUS HANDLING BEHAVIOR**

| <b>Service Status</b> | <b>Further Meaning</b>      | <b>Error Code</b> | <b>Behavior</b>                                                                                                        |
|-----------------------|-----------------------------|-------------------|------------------------------------------------------------------------------------------------------------------------|
| Success               | Success                     | 0000              | Film accepted for printing.<br>Print Job SOP instance is created, and the instance UID is returned                     |
| Warning               | Empty Film Page             | B603              | Film Box SOP instance hierarchy does not contain Image Box SOP instances (empty page). Empty page will not be printed. |
| Warning               | Image larger then Image Box | B604              | Image size is larger then Image Box size. Image has been de-magnified                                                  |
| Warning               | Image larger then Image Box | B609              | Image size is larger then Image Box size. Image has been clipped to fit it                                             |
| Warning               | Image larger then Image Box | B60A              | Image size is larger then Image Box size. Image has been decimated to fit it.                                          |
| Failure               | Out of Resources            | C602              | Unable to create Print Job SOP instance; print queue is full.                                                          |
| Failure               | Wrong Image size            | C603              | Image size is larger then Image Box size. The image will not be printed.                                               |
| Failure               | Wrong Print Image size      | C613              | Print Image size is greater then the Image Box size. The image will not be printed.                                    |

**E.4.2.1.4.1.3.2.3      Specific Conformance for Image Box SOP Class**

The EXAMPLE-PRINT-SERVER-MANAGEMENT provides the following support for the attributes contained in the N-SET DIMSE Service of the Basic Grayscale Image Box SOP Class:

**Table E.4.2-26  
IMAGE BOX SOP CLASS N-SET REQUEST ATTRIBUTES**

| <b>Attribute</b>               | <b>Tag</b>  | <b>Valid Range</b>                          | <b>Default Value if not sent by SCU or invalid value received</b> | <b>Response to Invalid Value</b> |
|--------------------------------|-------------|---------------------------------------------|-------------------------------------------------------------------|----------------------------------|
| Image Position                 | (2020,0010) | 1 - Max number of images for Display Format | Mandatory, no default.                                            | Failure (0x0106)                 |
| Basic Grayscale Image Sequence | (2020,0110) | N/A                                         | N/A                                                               | N/A                              |
| >Samples Per Pixel             | (0028,0002) | 1                                           | Mandatory, no default.                                            | Failure (0x0106)                 |
| >Photometric Interpretation    | (0028,0004) | MONOCHROME1<br>MONOCHROME2                  | Mandatory, no default.                                            | Failure (0x0106)                 |
| >Rows see Note 1               | (0028,0010) | 1 – Maximum rows for                        | Mandatory, no default.                                            | Failure (0x0106)                 |

|                                     |             |                                                       |                                              |                                 |
|-------------------------------------|-------------|-------------------------------------------------------|----------------------------------------------|---------------------------------|
|                                     |             | film size                                             |                                              | or (0xC603)                     |
| >Columns see Note 1                 | (0028,0011) | 1 – Maximum columns for film size.                    | Mandatory, no default.                       | Failure (0x0106)<br>or (0xC603) |
| >Pixel Aspect Ratio                 | (0028,0034) | Any pair of valid positive integers (1 to 215-1)      | 1:1                                          | Warning (0x116)                 |
| >Bits Allocated                     | (0028,0100) | 8 or 16                                               | Mandatory, no default.                       | Failure (0x0106)                |
| >Bits Stored see Note 4             | (0028,0101) | 8 – 16                                                | Mandatory, no default.                       | Failure (0x0106)                |
| >High Bit                           | (0028,0102) | 7-15                                                  | Mandatory, no default.                       | Failure (0x0106)                |
| >Pixel Representation               | (0028,0103) | 0 = unsigned<br>1 = 2's Complement                    | Mandatory, no default.                       | Failure (0x0106)                |
| Polarity                            | (2020,0020) | NORMAL<br>REVERSE                                     | NORMAL                                       | Failure (0x0106)                |
| Magnification Type See Note 2       | (2010,0060) | REPLICATE<br>BILINEAR<br>CUBIC<br>NONE                | Configurable                                 | Warning (0x116)                 |
| Smoothing Type See Note 3           | (2010,0080) | 0-15, the value is laser specific.                    | Configurable                                 | Warning (0x116)                 |
| Requested Image Size                | (2020,0030) | Up to the maximum row size for film size.             | Not set                                      | Warning (0x116)                 |
| Image Tone Adjustment               | (2001,1170) | 0 - None<br>1 – General<br>2 – CR Tone<br>3 – DR Tone | 0                                            | Failure (0x0106)                |
| Reference Presentation LUT Sequence | (2050,0500) | N/A                                                   | N/A                                          | N/A                             |
| >Referenced SOP Class UID           | (0008,1150) | SOP Class UID                                         | Mandatory if sequence is present, no default | Failure (0x0106)                |
| >Referenced SOP Instance UID        | (0008,1155) | SOP Instance UID                                      | Mandatory if sequence is present, no default | Failure (0x0106)                |

Note 1: Max Rows and Columns – The Maximum number of printable pixel matrix per supported Media size

Note 2: Magnification Type - Same as the attribute Magnification Type in Film Box, but used here for image based setting. If not specified, the value of this attribute inherits from Magnification Type in Film Box.

Note 3: Smoothing Type - If Magnification Type was cubic, this attribute allows the Laser Imager interpolation algorithm to be further defined.

Note 4: See the addition value in section E.8.8.1

The Print Server Management behavior and specific status codes sent for the N-SET of a specific Image Box is described in the following table:

**Table E.4.2-27  
IMAGE BOX SOP CLASS N-SET RESPONSE STATUS HANDLING BEHAVIOR**

| <b>Service Status</b> | <b>Further Meaning</b>      | <b>Error Code</b> | <b>Behavior</b>                                                                                                  |
|-----------------------|-----------------------------|-------------------|------------------------------------------------------------------------------------------------------------------|
| Success               | Success                     | 0000              | Some attributes may have different values than what was requested. The actual values of attributes are returned. |
| Warning               | Attribute out of range      | 0116              | The attribute in question is the only attribute returned in the responses data set.                              |
| Warning               | Image larger than Image Box | B604              | Image size is larger than Image Box size. Image has been de-magnified                                            |
| Warning               | Image larger than Image Box | B609              | Image size is larger than Image Box size. Image has been clipped to fit it                                       |
| Warning               | Image larger than Image Box | B60A              | Image size is larger than Image Box size. Image has been decimated to fit it.                                    |
| Failure               | No object instance          | 0112              | The given instance UID does not exist.                                                                           |
| Failure               | Missing attributes          | 0120              | Mandatory attributes are missing.<br>A list of missing mandatory attribute tags is returned.                     |
| Failure               | Missing attribute value     | 0121              | A mandatory attribute was given, but had no value.<br>A data set is returned of all attributes/values missing.   |
| Failure               | Image size doesn't match    | C603              | Image size exceeds Image Box dimensions.                                                                         |
| Failure               | Out of Resources            | C605              | Insufficient memory or disk space to store the image.                                                            |

**E.4.2.1.4.1.3.2.4 Specific Conformance for Printer SOP Class**

The EXAMPLE-PRINT-SERVER-MANAGEMENT supports the following DIMSE operations and notifications for the Printer SOP Class:

- N-GET
- N-EVENT-REPORT

Details of the supported attributes and status-handling behavior are described in the following subsections.

**E.4.2.1.4.1.3.2.4.1 Specific Conformance for Printer N-GET Status**

The Print SCU uses the Printer SOP Class N-GET operation to obtain information about the current Printer status. The attributes obtained via N-GET are listed in the table below.

The following tables (listing attributes are sent by the SCP) use a number of abbreviations. The abbreviations used in the "Presence of Value" column are:

- VNAP: Value Not Always Present (attribute sent zero length if no value is present)
- ANAP: Attribute Not Always Present
- ALWAYS: Always Present
- EMPTY: Attribute is sent without a value
- NS: Not supported – attribute is not being sent

**Table E.4.2-28  
Printer SOP Class N-GET Request Attributes**

| Attribute Name      | Tag         | VR | Value                                                                                                                                                                                                                                                                                                                                                                                                 | Presence of Value | Source  |
|---------------------|-------------|----|-------------------------------------------------------------------------------------------------------------------------------------------------------------------------------------------------------------------------------------------------------------------------------------------------------------------------------------------------------------------------------------------------------|-------------------|---------|
| Printer Status      | (2110,0010) | CS | NORMAL<br>WARNING<br>FAILURE                                                                                                                                                                                                                                                                                                                                                                          | ALWAYS            | Printer |
| Printer Status Info | (2110,0020) | CS | for NORMAL conditions:<br>"NORMAL"<br>for WARNING conditions:<br>"PRINTER INIT"<br>"SUPPLY LOW"<br>"NO SUPPLY MGZ"<br>"BAD SUPPLY MGZ"<br>"FILM JAM"<br>"SUPPLY EMPTY"<br>"COVER OPEN"<br>"ELEC DOWN"<br>"PROC INIT"<br>for FAILURE conditions<br>CHECK PRINTER"<br>ELEC CONFIG ERR<br>ELEC SW ERROR<br>PRINTER OFFLINE"<br>PRINTER DOWN<br>CALIBRATION ERR<br>FILM TRANS ERR<br>PROC DOWN<br>UNKNOWN | ALWAYS            | Printer |
| Printer Name        | (2110,0030) | LO | Any value up to 16 characters in length. Chosen by user at time of installation                                                                                                                                                                                                                                                                                                                       | ANAP              | Printer |
| Manufacturer        | (0008,0070) | LO | Any value up to 16 characters in length. Chosen by user at time of                                                                                                                                                                                                                                                                                                                                    | ANAP              | Printer |

|                         |             |    |                                                                                 |      |         |
|-------------------------|-------------|----|---------------------------------------------------------------------------------|------|---------|
|                         |             |    | installation                                                                    |      |         |
| Manufacturer Model Name | (0008,1090) | LO | Any value up to 16 characters in length. Chosen by user at time of installation | ANAP | Printer |
| Device Serial Number    | (0018,1000) | LO | number up to 8 ASCII characters                                                 | ANAP | Printer |
| Software Version        | (0018,1020) | LO | ID up to 6 ASCII characters                                                     | ANAP | Printer |
| Date Last Calibration   | (0018,1200) | DA | Provided by Printer                                                             | NS   | Printer |
| Last Calibration        | (0008,1090) | TM | Provided by Printer                                                             | NS   | Printer |

The Printer Status information is evaluated as follows:

1. If Printer status (2110,0010) is NORMAL, the print-job continues to be printed.
2. If Printer status (2110,0010) is FAILURE, the print-job is marked as failed. The contents of Printer Status Info (2110,0020) is logged
3. If Printer status (2110,0010) is WARNING, the print-job continues to be printed. The content of Printer Status Info (2110,0020) is logged.

The following status codes may be returned in response to Printer N-GET:

**Table E.4.2-29  
PRINTER SOP CLASS N-GET RESPONSE STATUS HANDLING BEHAVIOR**

| Service Status | Further Meaning | Error Code             | Behavior                                                                                                                                                                                                                                                        |
|----------------|-----------------|------------------------|-----------------------------------------------------------------------------------------------------------------------------------------------------------------------------------------------------------------------------------------------------------------|
| Success        | Success         | 0000                   | The request to get printer status information was success.                                                                                                                                                                                                      |
| Warning        | Warning         | 0107                   | Attributes not recognized within the context of this SOP class. For example, unsupported attributes were requested. A list of offending attribute tags is returned in Attribute List (0000,1005).<br>A data set is still returned with valid attributes/values. |
| Error          | Failure         | Any other status code. | The Association is aborted using A-ABORT and the print-job is marked as failed. The status meaning is logged and reported to the user.                                                                                                                          |

**E.4.2.1.4.1.3.2.4.2 Specific Conformance for Printer N-EVENT-REPORT status**

EXAMPLE-PRINT-SERVER-MANAGEMENT can be configured to send the Printer status information using the N-EVENT-REPORT DIMSE Service, asynchronously to all associated SCU that support the Printer SOP class. When the printer status is NORMAL, no attribute is sent. When the printer status is either WARNING or FAILURE, the following attributes are sent:

**Table E.4.2-30  
PRINTER SOP CLASS N-EVENT-REPORT ATTRIBUTES**

| Attribute Name      | Tag         | VR | Value                                                                                                                                                                                                                                                                                                                                                                                                                                                 | Presence of Value | Source  |
|---------------------|-------------|----|-------------------------------------------------------------------------------------------------------------------------------------------------------------------------------------------------------------------------------------------------------------------------------------------------------------------------------------------------------------------------------------------------------------------------------------------------------|-------------------|---------|
| Printer Name        | (2110,0030) | LO | Any value up to 16 characters in length. Chosen by user at time of installation                                                                                                                                                                                                                                                                                                                                                                       | ANAP              | Printer |
| Printer Status      | (2110,0010) | CS | NORMAL<br>WARNING<br>FAILURE                                                                                                                                                                                                                                                                                                                                                                                                                          | ALWAYS            | Printer |
| Printer Status Info | (2110,0020) | CS | If FAILURE:<br>-ELEC CONFIG ERR<br>-ELEC SW ERROR<br>-PRINTER DOWN<br>-UNKNOWN<br><br>If WARNING**:<br>-PROC INIT<br>-PROC DOWN<br>-PRINTER INIT<br>-CALIBRATION ERR<br>-PROC OVERFLOW FL<br>-CHEMICALS EMPTY<br>-CHECK CHEMISTRY<br>-PROC OVERFLOW HI<br>-CHEMICALS LOW<br>-BAD SUPPLY MGZ<br>-NO SUPPLY MGZ<br>-SUPPLY MGZ ERR<br>-SUPPLY EMPTY<br>-SUPPLY LOW<br>-RECEIVER FULL<br>-NO RECEIVE MGZ<br>-CALIBRATION ERR<br>-COVER OPEN<br>-FILM JAM | ALWAYS            | Printer |

The EXAMPLE-PRINT-SERVER-MANAGEMENT behavior when sending the N-EVENT-REPORT is summarized in the following table:

**Table E.4.2-31  
PRINTER SOP CLASS N-EVENT-REPORT BEHAVIOR**

| Event Type Name | Event Type ID | Behavior                                                                                                                                      |
|-----------------|---------------|-----------------------------------------------------------------------------------------------------------------------------------------------|
| Normal          | 1             | The print-job continues to be printed.                                                                                                        |
| Warning         | 2             | The print-job continues to be printed. The contents of Printer Status Info (2110,0020) is logged and reported to the user via the job-control |

|         |   |                                                                                                                                                        |
|---------|---|--------------------------------------------------------------------------------------------------------------------------------------------------------|
|         |   | application.                                                                                                                                           |
| Failure | 3 | The print-job is marked as failed. The contents of Printer Status Info (2110,0020) is logged and reported to the user via the job-control application. |
| *       | * | An invalid Event Type ID will cause a status code of 0113H to be returned in a N-EVENT-REPORT response.                                                |

#### E.4.2.1.4.1.3.3 Specific Conformance to Basic Annotation BOX SOP Class

The EXAMPLE-PRINT-SERVER-MANAGEMENT creates the Basic Annotation Box SOP instance at the time the Basic Film Box SOP instance is created, based on the value of the attribute Annotation Display Format ID (2010,0030) of the Basic Film Box.

The created Basic Annotation Box SOP instance can be updated with the N-SET DIMSE service. The following table describes the attributes that can be updated:

**Table E.4.2-32  
BASIC ANNOTATION BOX SOP CLASS N-SET REQUEST ATTRIBUTES**

| Attribute           | Tag         | Valid Range                                                        | Default Value if not sent by SCU or invalid value received | Response to Invalid Value |
|---------------------|-------------|--------------------------------------------------------------------|------------------------------------------------------------|---------------------------|
| Annotation Position | (2030,0010) | 0 - Max number of annotation strings defined for Annotation Format | Mandatory, no default.                                     | Failure (0x0106)          |
| Text String         | (2030,0020) | 1-64 characters                                                    | Null string                                                | Warning (0x116)           |

The Print Server Management behavior and specific status codes sent for the N-SET of a specific Annotation Box is described in the following table:

**Table E.4.2-33  
BASIC ANNOTATION BOX SOP CLASS N-SET RESPONSE STATUS HANDLING BEHAVIOR**

| Service Status | Further Meaning         | Error Code | Behavior                                                                                                         |
|----------------|-------------------------|------------|------------------------------------------------------------------------------------------------------------------|
| Success        | Success                 | 0000       | Some attributes may have different values than what was requested. The actual values of attributes are returned. |
| Warning        | Attribute out of range  | 0116       | The attribute in question is the only attribute returned in the responses data set.                              |
| Failure        | Invalid attribute value | 0106       | A data set is returned with all the invalid attributes/values.                                                   |
| Failure        | Processing failure      | 0110       | Can not decode the DIMSE attribute.                                                                              |
| Failure        | No object instance      | 0112       | The given instance UID does not exist.                                                                           |
| Failure        | Missing attributes      | 0120       | Mandatory attributes are missing.<br>A list of missing mandatory attribute tags is returned.                     |
| Failure        | Missing                 | 0121       | A mandatory attribute was given, but had no value.                                                               |



|  |                 |                                                          |
|--|-----------------|----------------------------------------------------------|
|  | attribute value | A data set is returned of all attributes/values missing. |
|--|-----------------|----------------------------------------------------------|

**E.4.2.1.4.1.3.4 Specific Conformance to Print Job Box sop class**

The EXAMPLE-PRINT-SERVER-MANAGEMENT supports the following DIMSE operations and notifications for the Print Job SOP Class:

- N-GET
- N-EVENT-REPORT

Details of the supported attributes and status-handling behavior are described in the following subsections.

**E.4.2.1.4.1.3.4.1 Specific Conformance for Print Job N-EVENTT-REPORT**

The EXAMPLE-PRINT-SERVER-MANAGEMENT can be configured to report the status of the Print job using the N-EVENT-REPORT DIMSE Service, asynchronously to the associated SCU which created the job and establishes the association to support the Print Job SOP Class. The Print Job N-EVENT-REPORT will provide the following information:

**Table E.4.2-34  
PRINT JOB SOP CLASS N-EVENT-REPORT ATTRIBUTES**

| Attribute Name        | Tag         | VR | Value                                                                                                                                                                                                                                                                | Presence of Value | Source  |
|-----------------------|-------------|----|----------------------------------------------------------------------------------------------------------------------------------------------------------------------------------------------------------------------------------------------------------------------|-------------------|---------|
| Printer Name          | (2110,0030) | LO | Any value up to 16 characters in length. Chosen by user at time of installation                                                                                                                                                                                      | ANAP              | Printer |
| Film Session Label    | (2000,0050) | LO | Up to 64 characters                                                                                                                                                                                                                                                  | ALWAYS            | Printer |
| Execution Status Info | (2100,0030) | CS | If PRINTING or DONE:<br>-NORMAL<br><br>If PENDING:<br>-QUEUED<br>-PROC INIT<br>-PROC DOWN<br>-PRINTER INIT<br>-CALIBRATION ERR<br>-PROC OVERFLOW<br>-CHEMICALS EMPTY<br>-CHECK CHEMISTRY<br>-PROC OVERFLOW HI<br>-CHEMICALS LOW<br>-BAD SUPPLY MGZ<br>-NO SUPPLY MGZ | ALWAYS            | Printer |

|  |  |  |                                                                                                                                                                                                                            |  |  |
|--|--|--|----------------------------------------------------------------------------------------------------------------------------------------------------------------------------------------------------------------------------|--|--|
|  |  |  | -SUPPLY MGZ ERR<br>-SUPPLY EMPTY<br>-SUPPLY LOW<br>-RECEIVER FULL<br>-NO RECEIVE MGZ<br>-CALIBRATION ERR<br>-COVER OPEN<br>FILM JAM<br><br>If FAILURE:<br>-JOB CANCELED<br>-INVALID PAGE DES<br>-ELEC SW ERROR<br>-UNKNOWN |  |  |
|--|--|--|----------------------------------------------------------------------------------------------------------------------------------------------------------------------------------------------------------------------------|--|--|

For each status type: PENDING, PRINTING, DONE and FAILURE, the following print job attributes are returned to the SCU:

**Table E.4.2-35  
PRINT JOB SOP CLASS N-EVENT-REPORT NOTIFICATION EVENTS INFORMATION**

| Event Type Name | Event Type ID | Attribute Name        | Tag         |
|-----------------|---------------|-----------------------|-------------|
| Pending         | 1             | Execution Status Info | (2100,0030) |
|                 |               | Print Job ID          | (2100,0010) |
|                 |               | Film Session Label    | (2000,0050) |
|                 |               | Printer Name          | (2110,0030) |
| Printing        | 2             | Execution Status Info | (2100,0030) |
|                 |               | Print Job ID          | (2100,0010) |
|                 |               | Film Session Label    | (2000,0050) |
|                 |               | Printer Name          | (2110,0030) |
| Done            | 3             | Execution Status Info | (2100,0030) |
|                 |               | Print Job ID          | (2100,0010) |
|                 |               | Film Session Label    | (2000,0050) |
|                 |               | Printer Name          | (2110,0030) |
| Failure         | 4             | Execution Status Info | (2100,0030) |
|                 |               | Print Job ID          | (2100,0010) |
|                 |               | Film Session Label    | (2000,0050) |
|                 |               | Printer Name          | (2110,0030) |

If the Event Type is Failure or Pending then the error/pending condition is sent to the SCU through the Execution Status Info element (2100,0030), as described in table 36.

When the Event Type is Done or Printing the Print Server is deleting the Print Job SOP Instance after receiving a confirmation from the Print SCU.

**E.4.2.1.4.1.3.4.2 Specific Conformance for Print Job N-get**

The EXAMPLE-PRINT-SERVER-MANAGEMENT support the Print Job N-GET requests. When a Print SCU needs to monitor the status of a print job, it can either maintain its association until the Print Server Management System notifies the SCU that the print job has completed, or it may open a new association with the Print Server Management System to track the print job using the Print Job SOP Class N-GET status.

The following table describes the Print Server Management System responds to a N-GET Print Job DIMSE Service request and returns the following attributes in support of Print Job SOP Class.

**Table E.4.2-36  
PRINT JOB SOP CLASS N-GET REQUEST ATTRIBUTES**

| Attribute Name        | Tag         | VR | Value                                                                                                      | Presence of Value | Source  |
|-----------------------|-------------|----|------------------------------------------------------------------------------------------------------------|-------------------|---------|
| Execution Status      | (2100,0020) | CS | PENDING<br>PRINTING<br>DONE<br>FAILURE                                                                     | ALWAYS            | Printer |
| Print Priority        | (2000,0020) | CS | HIGH<br>MED<br>LOW                                                                                         | ANAP              | Printer |
| Printer Name          | (2110,0030) | LO | Any value up to 16 characters in length. Chosen by user at time of installation                            | ANAP              | Printer |
| Originator            | (2100,0070) | AE | 16 bytes string for the SCU AE title that issued the print operation                                       | ANAP              | Printer |
| Creation Date         | (2100,0040) | DA | 8 bytes Date format string: YYYYMMDD for the Date of print job creation                                    | ANAP              | Printer |
| Creation Time         | (2100,0050) | TM | Up to 16 bytes Time string format: hhmmss.fraction for Time of print job creation                          | ANAP              | Printer |
| Execution Status Info | (2100,0030) | LO | If PRINTING or DONE:<br>-NORMAL<br><br>If PENDING:<br>-QUEUED<br>-PROC INIT<br>-PROC DOWN<br>-PRINTER INIT | ALWAYS            | Printer |

|  |  |  |                                                                                                                                                                                                                                                                                                                                                                                          |  |  |
|--|--|--|------------------------------------------------------------------------------------------------------------------------------------------------------------------------------------------------------------------------------------------------------------------------------------------------------------------------------------------------------------------------------------------|--|--|
|  |  |  | -CALIBRATION ERR<br>-PROC OVERFLOW FL<br>-CHEMICALS EMPTY<br>-CHECK CHEMISTRY<br>-PROC OVERFLOW HI<br>-CHEMICALS LOW<br>-BAD SUPPLY MGZ<br>-NO SUPPLY MGZ<br>-SUPPLY MGZ ERR<br>-SUPPLY EMPTY<br>-SUPPLY LOW<br>-RECEIVER FULL<br>-NO RECEIVE MGZ<br>-CALIBRATION ERR<br>-COVER OPEN<br>-FILM JAM<br><br>If FAILURE:<br>-JOB CANCELED<br>-INVALID PAGE DES<br>-ELEC SW ERROR<br>-UNKNOWN |  |  |
|--|--|--|------------------------------------------------------------------------------------------------------------------------------------------------------------------------------------------------------------------------------------------------------------------------------------------------------------------------------------------------------------------------------------------|--|--|

The following table describes the status codes and behavior of the Print Server reply in response to Print Job N-GET requested by the Print SCU:

**Table E.4.2-37  
PRINT JOB SOP CLASS N-GET RESPONSE STATUS HANDLING BEHAVIOR**

| <b>Service Status</b> | <b>Further Meaning</b>    | <b>Error Code</b> | <b>Behavior</b>                                                                                                                                                                                                |
|-----------------------|---------------------------|-------------------|----------------------------------------------------------------------------------------------------------------------------------------------------------------------------------------------------------------|
| Success               | Success                   | 0000              | The request is successful; printer information is returned.                                                                                                                                                    |
| Warning               | Attributes not recognized | 0107              | Attributes not recognized within the context of this SOP class.<br>A list of offending attribute tags is returned in Attribute List (0000,1005).<br>A data set is still returned with valid attributes/values. |
| Failure               | No such object instance   | 0112              | The instance UID given does not exist.                                                                                                                                                                         |

**E.4.2.1.4.1.3.5 Specific Conformance for Presentation LUT Box SOP class**

The Print Server Management System supports the Presentation LUT SOP class as SCP. Print SCU may negotiate this support and create a Presentation LUT instance prior to the creation of Film Boxes or Image Boxes. Multiple Presentation LUT instances are supported in an association, but only one instance will be supported for each image.

The SCU shall send either Presentation LUT Sequence or the Presentation LUT Shape. These values are mutually exclusive and the action will result in an error if neither or both are present. The presence of the Presentation LUT instance overrides any data set in the Configuration Information attribute (2010,0150) of the Film Box or Image Box.

The Print Server Management System provides support for the following DIMSE Services:

- N-CREATE
- N-DELETE

**E.4.2.1.4.1.3.5.1 Presentation LUT Box SOP class operation for N-CREATE**

The Print Server Management System supports the following attributes of the

N-CREATE DIMSE Service of the Presentation LUT SOP Class:

**Table E.4.2-38  
PRESENTATION LUT SOP CLASS N-CREATE REQUEST ATTRIBUTES**

| Attribute & Usage         | Tag         | Supported Values                                                                                                                                                                                                   | Default Values if not sent by SCU or invalid value received                                                            | Response to Invalid Value |
|---------------------------|-------------|--------------------------------------------------------------------------------------------------------------------------------------------------------------------------------------------------------------------|------------------------------------------------------------------------------------------------------------------------|---------------------------|
| Presentation LUT Sequence | (2050,0010) |                                                                                                                                                                                                                    | None.                                                                                                                  |                           |
| >LUT Descriptor           | (0028,3002) | The first value is the number of entries in the lookup table<br>The second value represents the first mapped value of the LUT. The third value shall be 10-16 (which represents the bit depth of each LUT entries. | First value should be the number of LUT entries.<br><br>Second value should be 0<br><br>The third value default is 12. | Failure (0x0106)          |
| >LUT Explanation          | (0028,3003) |                                                                                                                                                                                                                    | None.                                                                                                                  | NA                        |
| >LUT Data                 | (0028,3006) |                                                                                                                                                                                                                    | None.                                                                                                                  |                           |
| Presentation LUT Shape    | (2050,0020) | Enumerated values: IDENTITY or LIN OD.                                                                                                                                                                             | None.                                                                                                                  | Failure (0x0107)          |

The Print Server Management behavior and specific status codes sent for the N-CREATE of a specific Presentation LUT is described in the following table:

**Table E.4.2-39  
PRESENTATION LUT SOP CLASS N-CREATE RESPONSE STATUS HANDLING BEHAVIOR**

| Service Status | Further Meaning                                                           | Error Code | Behavior                                                                          |
|----------------|---------------------------------------------------------------------------|------------|-----------------------------------------------------------------------------------|
| Success        | Success                                                                   | 0000       | The SCP has completed successfully the creation of the Presentation LUT.          |
| Warning        | Requested Min Density or Max Density outside of printer's operating range | B605H      | The N-CREATE operation is considered successful but the status meaning is logged. |
| Failure        | Invalid LUT Descriptor values                                             | 0106       | Reject the Presentation LUT                                                       |
| Failure        | Invalid Presentation LUT Shape value                                      | 0107       | Reject the Presentation LUT Shape                                                 |
| Failure        | Send both Presentation LUT and Presentation LUT Shape                     | 0108       | Reject both the Presentation LUT and Presentation LUT Shape.                      |

**E.4.2.1.4.1.3.5.2 Presentation LUT Box SOP class operation for n-DELETE**

When a N-DELETE DIMSE service is requested with a specific Presentation LUT SOP instance, the Print Server Management System will not delete the specified Presentation LUT SOP instance as long as there are outstanding references to it. Otherwise, it deletes the specified Presentation LUT SOP instance.

**E.4.2.1.4.1.3.5.3 Consistent Presentation of Grayscale Images**

The EXAMPLE-PRINT-SERVER-MANAGEMENT supports the DICOM standard (PS 3-14) Grayscale Standard Display Function (GSDF) for Consistent Presentation of Displayed and Printed Images. The Image Consistency is achieved through the support of the Presentation LUT (transforming the image pixels value in to the Standard Presentation P-values) and then Transforming the Image pixel values from the standard Presentation (P-value) space to the Optical Density space. Calibrating the Imager Printer Device to adjust the Printer Imager characteristic curve to fit the GSDF curve. The EXAMPLE-PRINT-SERVER-MANAGEMENT Service Manual describes in details the Imager Printer calibration to the DICOM GSDF curve.

**E.4.2.1.4.1.3.6 Specific Conformance for Printer Configuration SOP class**

The EXAMPLE-PRINT-SERVER-MANAGEMENT is supporting the Printer Configuration N-GET requested by the Print SCU. The following table describes the Printer Configuration attributes:

**Table E.4.2-40  
PRINTER CONFIGURATION SOP CLASS N-GET RESPONSE ATTRIBUTES**

| Attribute Name                 | Tag         | VR | Value                                    | Presence of Value | Source  |
|--------------------------------|-------------|----|------------------------------------------|-------------------|---------|
| Printer Configuration Sequence | (2000,001E) | SQ | Sequence of the configuration attributes | ALWAYS            | Printer |
| >SOP Classes Supported         | (0008,115A) | UI | SOP Class supported UID.                 | ANAP              | Printer |

|                                           |             |    |                                               |      |         |
|-------------------------------------------|-------------|----|-----------------------------------------------|------|---------|
| >Maximum Memory Allocation                | (2000,0061) | IS | See Film (page) sizes                         | ANAP | Printer |
| >Memory Bit Depth                         | (2000,00A0) | US | 8 through 16                                  | ANAP | Printer |
| >Printing Bit Depth                       | (2000,00A1) | US | 8 or 12                                       | ANAP | Printer |
| >Media Installed Sequence                 | (2000,00A2) | SQ |                                               | ANAP | Printer |
| >>Item Number                             | (0020,0019) | IS |                                               | ANAP | Printer |
| >>Medium Type see Note 1                  | (2000,0030) | CS | BLUE FILM,<br>CLEAR FILM,<br>PAPER<br>CURRENT | ANAP | Printer |
| >>Film Size ID see Note 1                 | (2010,0050) | CS | 8INX10IN<br>11INX14IN<br>14INX17IN<br>CURRENT | ANAP | Printer |
| >>Min Density                             | (2010,0120) | US | 0..50                                         | ANAP | Printer |
| >>Max Density                             | (2010,0130) | US | 0..400                                        | ANAP | Printer |
| >Supported Image Display Formats Sequence | (2000,00A8) | SQ |                                               | ANAP | Printer |
| >>Rows                                    | (0028,0010) | US | 1 to Max Film rows                            | ANAP | Printer |
| >>Columns                                 | (0028,0011) | US | 1 to max Film columns                         | ANAP | Printer |
| >>Image Display Format                    | (2010,0010) | ST | STANDARD\C,R<br>ROW\R1,R2,R3<br>COL\C1,C2,C3  | ANAP | Printer |
| >>Film Orientation                        | (2010,0040) | CS | PORTRAIT<br>LANDSCAPE                         | ANAP | Printer |
| >>Film Size ID see Note 1                 | (2010,0050) | CS | 8INX10IN<br>11INX14IN<br>14INX17IN<br>CURRENT | ANAP | Printer |
| >>Printer Resolution ID                   | (2010,0052) | CS | STANDARD<br>HIGH                              | ANAP | Printer |
| >>Printer Pixel Spacing                   | (2010,0376) | DS | Pair of decimal numbers                       | ANAP | Printer |
| >>Requested Image Size Flag               | (2020,00A0) | CS | YES<br>NO                                     | ANAP | Printer |
| >Default Printer Resolution ID            | (2010,0054) | CS | STANDARD<br>HIGH                              | ANAP | Printer |

|                             |             |    |                                                                                 |      |         |
|-----------------------------|-------------|----|---------------------------------------------------------------------------------|------|---------|
| >Default Magnification Type | (2010,00A6) | CS | REPLICATE<br>BILINEAR<br>CUBIC<br>NONE                                          | ANAP | Printer |
| >Default Smoothing Type     | (2010,00A8) | CS | 0-15, the value is laser specific.                                              | ANAP | Printer |
| >Maximum Collated Films     | (2010,0154) | IS | 1..100                                                                          | ANAP | Printer |
| >Decimate/Crop Result       | (2020,00A2) | CS | DECIMATE<br>CROP<br>FAIL                                                        | ANAP | Printer |
| >Manufacturer               | (0008,0070) | LO | Any value up to 16 characters in length. Chosen by user at time of installation | ANAP | Printer |
| >Manufacturer Model Name    | (0008,1090) | LO | Any value up to 16 characters in length. Chosen by user at time of installation | ANAP | Printer |
| >Printer Name               | (2110,0030) | LO | Any value up to 16 characters in length. Chosen by user at time of installation | ANAP | Printer |

Note 1: See the addition value "CURRENT" in section E.8.8.1

### E.4.3 NETWORK INTERFACES

#### E.4.3.1 Physical Network Interface

The EXAMPLE-PRINT-SERVER-MANAGEMENT supports a single network interface. One of the following physical network interfaces will be available depending on installed hardware options:

**Table E.4.3-1  
SUPPORTED PHYSICAL NETWORK INTERFACES**

|                   |
|-------------------|
| Ethernet 100baseT |
| Ethernet 10baseT  |

#### E.4.3.2 Additional Protocols

DHCP can be used to obtain TCP/IP network configuration information (e.g. own TCP/IP address, net-mask, default gateway, DNS server, etc). Support for DHCP can be configured via the Configuration Service/Installation Tool. . If DHCP is not in use, TCP/IP network configuration information can be manually configured via the Service/Installation Tool.

DNS can be used for address resolution. If DHCP is not in use, the identity of a DNS server can be configured via the Service/Installation Tool. If a DNS server is not in use, local mapping between hostname and TCP/IP address can be manually configured via the Service/Installation Tool.

#### E.4.3.3 IPv4 and IPv6 Support

This product supports both IPv4 and IPv6. It does not utilize any of the optional configuration identification or security features of IPv6.



## E.4.4 CONFIGURATION

### E.4.4.1 AE Title/Presentation Address Mapping

#### E.4.4.1.1 Local AE Titles

All local applications use the AETs and TCP/IP Ports configured via the Service/Installation Tool. The Field Service Engineer can configure the IP Address via the Service/Installation Tool. No Default AE Titles are provided. The AE Titles must be configured during installation. The local AET used by each individual application can be configured independently of the AET used by other local applications. If so configured, all local AEs are capable of using the same AET.

The EXAMPLE-PRINT-SERVER-MANAGEMENT is configured via the Configuration Service/Installation Tool as follows

**Table E.4.4-1  
AE TITLE CONFIGURATION TABLE**

| Application Entity | Default AE Title   | Default TCP/IP Port |
|--------------------|--------------------|---------------------|
| PRINT-SCP          | Must be configured | 104                 |

#### E.4.4.1.2 Remote AE Title/Presentation Address Mapping

The AET, host names and port numbers of remote applications are configured using the EXAMPLE-PRINT-SERVER-MANAGEMENT Service/Installation Tool.

#### E.4.4.1.2.1 Print Server Management

The EXAMPLE-PRINT-SERVER-MANAGEMENT Service/Installation tool must be used to set the AETs, port-numbers, host-names, Local Network Host Name, Router Address(Gateway), Sub-net Mask, IP-addresses (if no DHCP is used) and other capabilities for the remote Print SCUs. Multiple remote Print SCUs can be defined.

#### E.4.4.2 Parameters

A large number of parameters related to Print Management, Communications and general operation can be configured using the Service/Installation Tool. The following table shows those configuration parameters relevant to DICOM communication. See the EXAMPLE-PRINT-SERVER-MANAGEMENT Configuration Service Manual for details on general configuration capabilities.

**Table E.4.4-2  
CONFIGURATION PARAMETERS TABLE**

| Parameter                                                                                                                                                                                                                                                                                                                               | Configurable (Yes/No) | Default Value |
|-----------------------------------------------------------------------------------------------------------------------------------------------------------------------------------------------------------------------------------------------------------------------------------------------------------------------------------------|-----------------------|---------------|
| <b>General Parameters</b>                                                                                                                                                                                                                                                                                                               |                       |               |
| Max PDU Receive Size                                                                                                                                                                                                                                                                                                                    | Yes                   | 128 KB        |
| Max PDU Send Size<br>(If the receiver supports a smaller Max PDU Receive Size then the Max PDU Send Size will be reduced accordingly for the duration of the Association. Max PDU Receive Size information is exchanged during DICOM Association Negotiation in the Maximum Length Sub-Item of the A-ASSOCIATION-RQ and A-ASSOCIATE-AC) | Yes                   | 128 KB        |
| Time-out waiting for a acceptance or rejection response to an Association Request (Application level Timeout).                                                                                                                                                                                                                          | Yes                   | 20 s          |
| Time-out waiting for a response to an Association release request (Application level Timeout)                                                                                                                                                                                                                                           | Yes                   | 30 s          |

| Parameter                                                                                                                                                                                                                                                                       | Configurable (Yes/No) | Default Value                                                                   |
|---------------------------------------------------------------------------------------------------------------------------------------------------------------------------------------------------------------------------------------------------------------------------------|-----------------------|---------------------------------------------------------------------------------|
| Time-out waiting for completion of a TCP/IP connect request (Low-level timeout)                                                                                                                                                                                                 | Yes                   | 20 s                                                                            |
| Time-out awaiting a Response to a DIMSE Request (Low level Timeout)                                                                                                                                                                                                             | Yes                   | 360 s                                                                           |
| Time-out for waiting for data between TCP/IP-packets (Low level Timeout)                                                                                                                                                                                                        | Yes                   | 30 s                                                                            |
| Maximum number of simultaneous Associations                                                                                                                                                                                                                                     | Yes                   | 8                                                                               |
| Supported Transfer Syntaxes                                                                                                                                                                                                                                                     | Yes                   | Implicit VR Little Endian<br>Explicit VR Little Endian                          |
| <b>Print Server Management</b>                                                                                                                                                                                                                                                  |                       |                                                                                 |
| Default Print parameters: Max density, Min Density, Contrast, Border Density, Trim, Magnification type, Smoothing factor, Polarity, Number of Copies, Cropping Algorithm, Orientation.                                                                                          | Yes                   | Configurable                                                                    |
| Number of times a failed print-job may be retried                                                                                                                                                                                                                               | Yes                   | 3                                                                               |
| Delay between retrying failed print-jobs                                                                                                                                                                                                                                        | Yes                   | 60s                                                                             |
| Printer Bit-depth Configurable: 8 or 12                                                                                                                                                                                                                                         | Yes                   | 12                                                                              |
| Custom Format                                                                                                                                                                                                                                                                   | No                    | NA                                                                              |
| Media Type: Transparent (Film), Reflective (Paper)                                                                                                                                                                                                                              | Yes                   | Transparent                                                                     |
| Media size Configurable: 8IN X 10IN, 11IN X 14IN, 14IN X 14IN, 14IN X 17IN                                                                                                                                                                                                      | Yes                   | 14IN X 17IN                                                                     |
| Maximum number of printable pixel matrix per supported Media size; see Note 1                                                                                                                                                                                                   | No                    | 8x10 – 2286x2836<br>11x14 – 4096x3195<br>14x14 – 4096x4108<br>14x17 – 4096x5120 |
| Maximum number of collated films in a film session                                                                                                                                                                                                                              | Yes                   | 12                                                                              |
| Support N-EVENT-REPORT (On/Off for either Printer, Print Job or both).                                                                                                                                                                                                          | Yes                   | On                                                                              |
| Handling of print jobs when requested Media Type and/or Film Size are not currently installed. The options are:<br>1. Queue the print job until the film matching the requested Media Type and/or Film Size is loaded.<br>2. Print on the film currently loaded in the printer. | Yes                   | Print on available media                                                        |
| Print SCP time-out waiting for a SCU confirmation to a Print Status N-EVENT- REPORT                                                                                                                                                                                             | Yes                   | 60 s                                                                            |
| Print SCP time-out waiting for a SCU confirmation to a Print Job N-EVENT- REPORT                                                                                                                                                                                                | Yes                   | 60 s                                                                            |
| Supported Transfer Syntaxes (separately configurable for each                                                                                                                                                                                                                   | Yes                   | Implicit VR Little                                                              |

| <b>Parameter</b>    | <b>Configurable<br/>(Yes/No)</b> | <b>Default Value</b>                   |
|---------------------|----------------------------------|----------------------------------------|
| remote SCU printer) |                                  | Endian<br>Explicit VR Little<br>Endian |

Note 1: The adjustment (Magnification or Clipping) of the original image to the Printable image size is described in the Printer Service Manual.

## **E.5 MEDIA INTERCHANGE**

The EXAMPLE-PRINT-SERVER-MANAGEMENT does not support Media Storage.

## **E.6 SUPPORT OF CHARACTER SETS**

The EXAMPLE-PRINT-SERVER-MANAGEMENT supports the following Character sets:

ISO\_IR 100 (ISO 8859-1:1987 Latin Alphabet No. 1 supplementary set)

ISO\_IR 144 (ISO 8859-5:1988 Latin/Cyrillic Alphabet supplementary set)

## **E. 7SECURITY**

The EXAMPLE-PRINT-SERVER-MANAGEMENT does not support any specific security measures.

## E.8 ANNEXES

### E.8.1 IOD CONTENTS

#### E.8.1.1 Created IOD Instance(s)

The EXAMPLE-PRINT-SERVER-MANAGEMENT creates the following IOD types of instances: Image Boxes, Annotation Boxes, Print Jobs, Printer, and Printer Configuration.

The attributes of the created IODs are described in the SOP Specific Conformance, section E.4.2.1.4.1.3.

#### E.8.1.2 Usage of Attributes from received IOD's

The usage of attributes received in the IODs sent by the Print SCU is described in the SOP Specific Conformance, section E.4.2.1.4.1.3.

#### E.8.1.3 Attribute Mapping

The following table is a mapping table of attributes that can be set by different Print IODs. If more than one IOD is setting the same element, then the value will be over-written by the IOD's value in the order from left to right, such that the Printer Configuration (PC) specific element values (as described in the mapping table #45) is in lowest order might be overwritten by any other IOD.

**Table E.8.1-1  
PRINT SERVER ATTRIBUTE MAPPING**

| Attribute Name            | Tag         | PC | FS | FB | IB | PI | PJ |
|---------------------------|-------------|----|----|----|----|----|----|
| Print Priority            | (2000,0020) |    | X  |    |    |    | X  |
| Medium Type               | (2000,0030) | X  | X  |    |    |    |    |
| Image Display Format      | (2010,0010) | X  |    | X  | X  |    |    |
| Film Orientation          | (2010,0040) | X  |    | X  |    |    |    |
| Film Size ID              | (2010,0050) | X  |    | X  |    |    |    |
| Magnification Type        | (2010,0060) |    |    | X  | X  |    |    |
| Smoothing Type            | (2010,0080) |    |    | X  | X  |    |    |
| Min Density               | (2010,0120) | X  |    | X  |    |    |    |
| Max Density               | (2010,0130) | X  |    | X  |    |    |    |
| Configuration Information | (2010,0150) |    |    | X  | X  |    |    |
| Printer Name              | (2110,0030) |    |    |    |    | X  | X  |

#### Print Management IODs Abbreviations

PC – Printer Configuration

FS – Film Session

FB – Film Box

IB – Image Box

PI – Printer Information

PJ – Print Job

The IOD's in the above table are in the order from Left to Right over-writing values that are already set by previous IOD's. For Example: the Print Priority element can be set by both the Film Session and the Print Job, however if both IODs are setting this values then the Print Job Print Priority value will over write the Film Session Print Priority value.

#### E.8.1.4 Coerced/Modified Fields

The EXAMPLE-PRINT-SERVER-MANAGEMENT AE will truncate attribute values received from the Print Composer (SCU) if the value length is longer than the maximum length permitted by the attribute VR.

### E.8.2 DATA DICTIONARY OF PRIVATE ATTRIBUTES

The EXAMPLE-PRINT-SERVER-MANAGEMENT AE System reserves private attribute values in group 2001. The private attributes added to created SOP instances are listed in the following table:

**Table E.8.2-1**  
**DATA DICTIONARY OF PRIVATE ATTRIBUTES**

| Tag         | Attribute Name        | VR | VM | Attribute Description                       |
|-------------|-----------------------|----|----|---------------------------------------------|
| (2001,00xx) | Private creator       |    |    | PRINT SERVER_2001                           |
| (2001,xx00) | Sheets Left           | IS | 1  | Number of sheets left in the film magazine. |
| (2001,xx70) | Image Tone Adjustment | LO | 1  | Specify tone scaling for the image          |

### E.8.3 CODED TERMINOLOGY AND TEMPLATES

The EXAMPLE-PRINT-SERVER-MANAGEMENT is not using any Codes (SNOMED) or Controlled Terminology, such as the use of the DICOM Content Mapping Resource (DCMR).

### E.8.4 GRAYSCALE IMAGE CONSISTENCY

The EXAMPLE-PRINT-SERVER-MANAGEMENT AE supports the Grayscale Standard Display Function (GSDF) as described in PS 3.14, for the Printer Calibration and Hardcopy Image Consistency.

### E.8.5 STANDARD EXTENDED / SPECIALIZED / PRIVATE SOP CLASSES

#### E.8.5.1 Standard Extended Basic Film Session SOP Class

The EXAMPLE-PRINT-SERVER-MANAGEMENT is making the following extensions to DICOM SOP Classes:

**SOP Class:** Basic Film Session SOP

**Attribute:** Film Destination (2000,0040)

**Extensions value:** CURRENT

This extension allows the SCU to print on the destination currently configured at the printer.

**SOP Class:** Basic Film Session SOP

**Attribute:** Medium Type (2000, 0030)

**Extensions:** CURRENT

This extension allows images to be printed on whatever media type is currently loaded in the printer.

Note that if Medium Type is specified, and a media type other than that requested is installed, then the EXAMPLE-PRINT-SERVER-MANAGEMENT will return success (0x0) and will either queue the print job until the correct media type is installed, or print on the media currently installed, based on the EXAMPLE-



PRINT-SERVER-MANAGEMENT configuration. Specifying the Media Type to CURRENT will ensure that the print job will always be printed.

If Medium Type is not specified, then the default CURRENT will be used, allowing images to always be printed.

#### **E.8.5.2 Standard Extended Basic Film Box SOP Class**

**SOP Class:** Basic Film Box SOP

**Attribute:** Film Size (2010, 0050)

**Extensions:** CURRENT

This extension allows images to be printed on whatever film size is currently loaded in the printer.

Note that if Film Size is specified, and a size other than that requested is installed, the EXAMPLE-PRINT-SERVER-MANAGEMENT will return success (0x0), and will either queue the print job until the correct sized film is installed or print on the media currently installed, based on the EXAMPLE-PRINT-SERVER-MANAGEMENT configuration. Specifying the Film Size to CURRENT will ensure that the print job will always be printed.

If Film Size is not specified, then the default CURRENT will be used, allowing images to always be printed.

#### **E.8.5.3 Standard Extended Basic Grayscale Image Box SOP Class**

**SOP Class:** Basic Grayscale Image Box SOP

**Attribute:** Bits Stored (0028, 0101)

**Extensions:** 8-16 bits stored are supported.

DICOM only specifies 8 and 12 for number of bits stored. The EXAMPLE-PRINT-SERVER-MANAGEMENT supports the number of bits stored to be from 8 through 16 bits.

**SOP Class:** Basic Grayscale Image Box SOP

**Attribute:** High Bit (0028, 0102)

**Extensions:** High Bit positions 7 - 15 are supported.

DICOM specifies that the high bit must be the 7th or 11th bit (for 8 or 12 bits stored, respectively). The EXAMPLE-PRINT-SERVER-MANAGEMENT supports the high bit to be the number of bits stored minus one. For example, if the number of bits stored is 13, the high bit is 12.

#### **E.8.6 PRIVATE TRANSFER SYNTAXES**

No Private Transfer Syntaxes is supported.

## **ANNEX F (informative) DICOM CONFORMANCE STATEMENT QUERY-RETRIEVE-SERVER**

Disclaimer:

This document is an example DICOM Conformance Statement for a fictional device called EXAMPLE-QUERY-RETRIEVE-SERVER, which is a self-contained networked computer system used for archiving diagnostic medical images.

As stated in the annex title, this document is truly informative, and not normative. A conformance statement of an actual product might implement additional services and options as appropriate for its specific purpose. In addition, an actual product might implement the services described in a different manner and, for example, with different characteristics and/or sequencing of activities. In other words, this conformance statement example does not intend to standardize a particular manner that a product might implement DICOM functionality.

**F.0 COVER PAGE**

Company Name: EXAMPLE-ARCHIVING-PRODUCTS.

Product Name: SAMPLE QUERY-RETRIEVE-SERVER

Version: 1.0-rev. A.1

Internal document number: 4226-xxx-yyy-zzz rev 1

Date: YYYYMMDD

## F.1 CONFORMANCE STATEMENT OVERVIEW

The EXAMPLE-QUERY-RETRIEVE-SERVER is a self-contained networked computer system used for archiving diagnostic medical images. It allows external systems to send images to it for permanent storage, retrieve information about such images, and retrieve the images themselves. The system conforms to the DICOM standard to allow the sharing of medical information with other digital imaging systems.

**Table F.1-1  
NETWORK SERVICES**

| <b>SOP Classes</b>                 | <b>User of Service (SCU)</b> | <b>Provider of Service (SCP)</b> |
|------------------------------------|------------------------------|----------------------------------|
| <b>Transfer</b>                    |                              |                                  |
| US Image Storage (Retired)         | Yes                          | Yes                              |
| US Image Storage                   | Yes                          | Yes                              |
| US Multi-frame Storage (Retired)   | Yes                          | Yes                              |
| US Multi-frame Storage             | Yes                          | Yes                              |
| Computed Radiography Image Storage | Yes                          | Yes                              |
| CT Image Storage                   | Yes                          | Yes                              |
| MR Image Storage                   | Yes                          | Yes                              |
| Secondary Capture Image Storage    | Yes                          | Yes                              |
| Storage Commitment                 |                              |                                  |
| Storage Commitment Push Model      | No                           | Yes                              |
| <b>Query/Retrieve</b>              |                              |                                  |
| Patient Root Q/R - FIND            | No                           | Yes                              |
| Patient Root Q/R - MOVE            | No                           | Yes                              |
| Study Root Q/R - FIND              | No                           | Yes                              |
| Study Root Q/R - MOVE              | No                           | Yes                              |

NOTE: Relational Queries are not supported either as an SCU or SCP.

## **F.2 TABLE OF CONTENTS**

A table of contents shall be provided to assist readers in easily finding the needed information.

## F.3 INTRODUCTION

### F.3.1 REVISION HISTORY

| Document Version | Date             | Author    | Description            |
|------------------|------------------|-----------|------------------------|
| 1.1              | October 30, 2003 | DICOM WG6 | Version for Final Text |
| 1.2              | August 30, 2007  | WG 6      | Revised Introduction   |

### F.3.2 AUDIENCE, REMARKS, TERMS AND DEFINITIONS, BASICS OF DICOM COMMUNICATION, ABBREVIATIONS, REFERENCES

*See example text in Annex A.3.*

### F.3.3 ADDITIONAL REMARKS FOR THIS EXAMPLE

This document is a sample DICOM Conformance Statement created for DICOM PS3.2. It is to be used solely as an example to illustrate how to create a DICOM Conformance Statement for an image storage system supporting DICOM images. The subject of the document, EXAMPLE-QUERY-RETRIEVE-SERVER, is a fictional product.

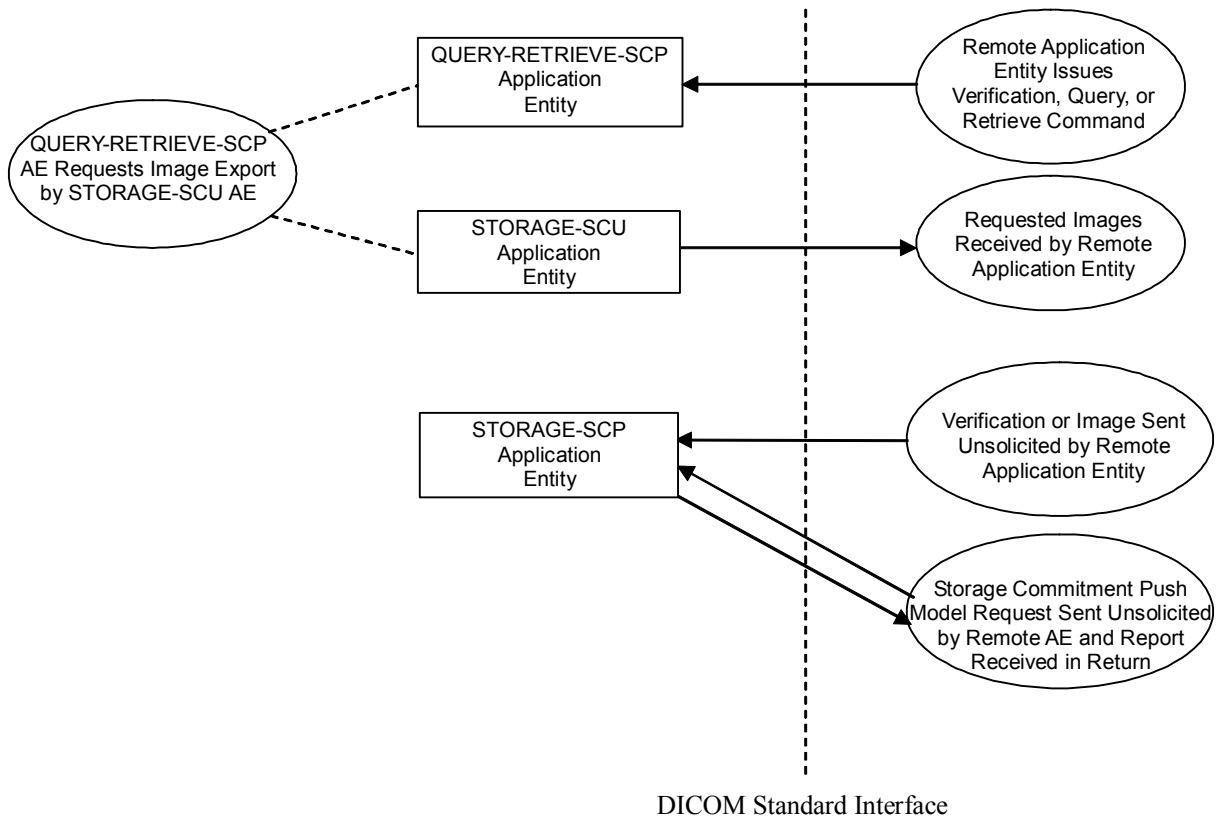
## F.4 NETWORKING

### F.4.1 IMPLEMENTATION MODEL

#### F.4.1.1 Application Data Flow

The division of EXAMPLE-QUERY-RETRIEVE-SERVER into the separate DICOM Application Entities represents a somewhat arbitrary partitioning of functionality. For the purpose of this document they are organized in this manner so as to detail their independent logical functionality.

By default all of the defined Application Entities have different AE Titles. However, EXAMPLE-QUERY-RETRIEVE-SERVER can be configured so that the QUERY-RETRIEVE-SCP AE and STORAGE-SCU AE share the same Application Entity Title. However, the QUERY-RETRIEVE-SCP AE and STORAGE-SCP AE must have separate Application Entity Titles.



**Figure F.4.1-1**  
**EXAMPLE-QUERY-RETRIEVE-SERVER DICOM DATA FLOW DIAGRAM**

The Application Entities detailed in the Application Data Flow Diagram are all Windows NT applications.

- The STORAGE-SCU AE can send Composite SOP Instances. It handles requests from the QUERY-RETRIEVE-SCP AE to transmit Images to a specific DICOM destination. The STORAGE-SCU AE functions as a C-STORE SCU. (Note that in this example Conformance Statement this STORAGE-SCU AE does not allow a Local User to request that images be sent to a Remote AE. If a 'real' AE does allow this then this should be mentioned here and in the other appropriate areas of the Conformance Statement).
- The QUERY-RETRIEVE-SCP AE can handle incoming query and retrieve requests. It can handle external queries for Patient, Study, Series, and Image data, and also handle Image retrieval requests. The QUERY-RETRIEVE-SCP AE handles retrieval requests by issuing a command to the STORAGE-SCU AE to send the requested Images to the destination specified by the Remote AE. The QUERY-RETRIEVE-SCP AE functions as an SCP for C-FIND and C-MOVE requests.
- The STORAGE-SCP AE can receive incoming DICOM images and add them to the EXAMPLE-QUERY-RETRIEVE-SERVER database. It can respond to external Storage and Verification Requests as a Service Class Provider (SCP) for C-STORE and C-ECHO requests. The STORAGE-SCP AE can also handle Storage Commitment Push Model Requests. It can thus be used to query whether the EXAMPLE-QUERY-RETRIEVE-SERVER will confirm ownership and responsibility for specific Composite SOP Instances. The STORAGE-SCP AE currently only supports image type Composite SOP Instances.

#### **F.4.1.2 Functional Definition of AEs**

##### **F.4.1.2.1 Functional Definition of STORAGE-SCU Application Entity**

The STORAGE-SCU AE can be invoked by the QUERY-RETRIEVE-SCP AE to trigger the transfer of specific images to a remote destination AE. The STORAGE-SCU AE must be correctly configured with the host and port number of any external DICOM AE's that are to be C-MOVE retrieval destinations. The Presentation Contexts to use are determined from the headers of the DICOM files to be transferred. Some conversion of the DICOM image objects is possible if the original Presentation Context is not supported by the remote destination AE or if compression is preferred.

##### **F.4.1.2.2 Functional Definition of QUERY-RETRIEVE-SCP Application Entity**

The QUERY-RETRIEVE-SCP AE waits for another application to connect at the presentation address configured for its Application Entity Title. When another application connects, QUERY-RETRIEVE-SCP AE expects it to be a DICOM application. QUERY-RETRIEVE-SCP AE will accept Associations with Presentation Contexts for SOP Classes of the DICOM Query-Retrieve Service Class, and Verification Service Class. It will handle query and retrieve requests on these Presentation Contexts and respond with data objects with values corresponding to the contents of the EXAMPLE-QUERY-RETRIEVE-SERVER database. For C-MOVE requests the destination for the image objects is determined from the Destination AE Title contained in the C-MOVE request. When a retrieval request is received, the QUERY-RETRIEVE-SCP AE issues a command to the STORAGE-SCU AE to send the specified images to the C-MOVE Destination AE.

##### **F.4.1.2.3 Functional Definition of STORAGE-SCP Application Entity**

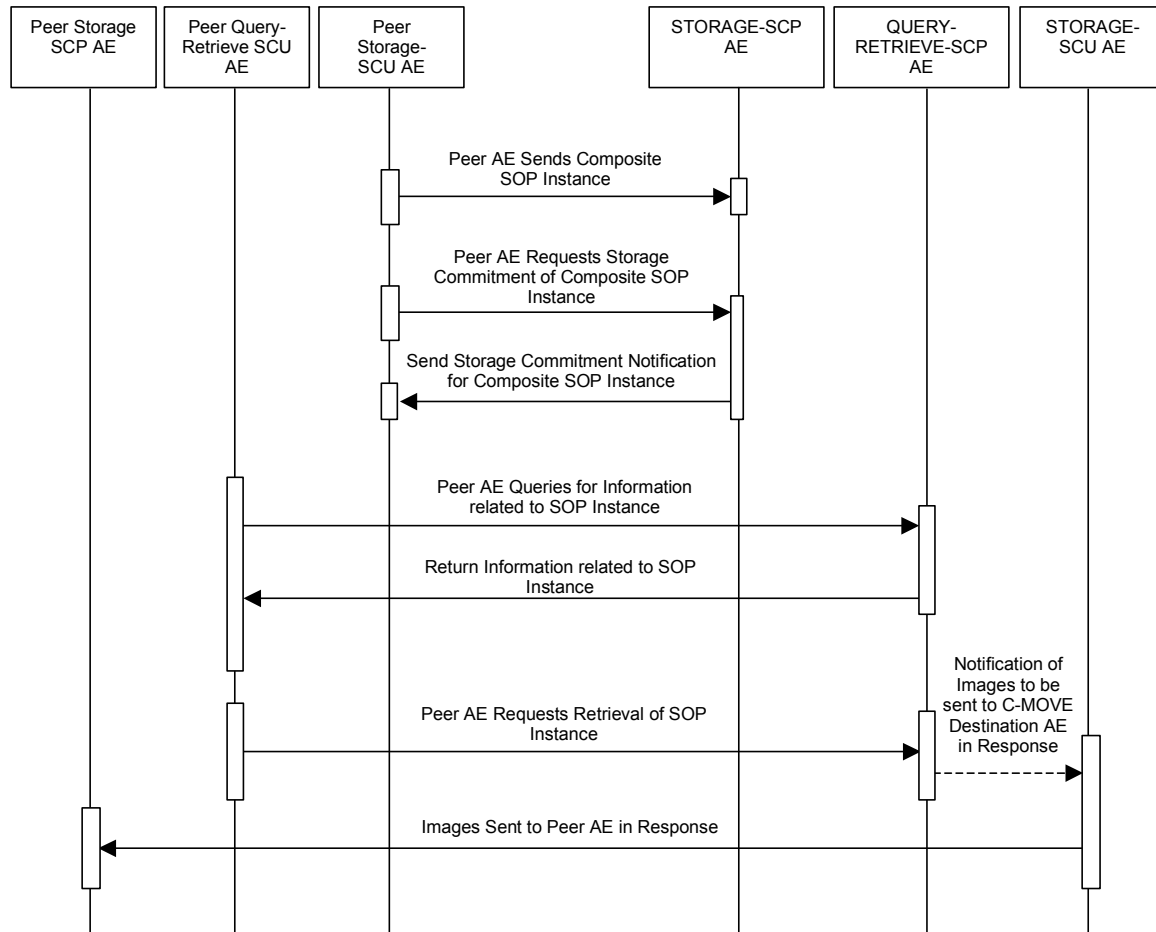
The STORAGE-SCP AE waits for another application to connect at the presentation address configured for its Application Entity Title. When another application connects, the STORAGE-SCP AE expects it to be a DICOM application. The STORAGE-SCP AE will accept Associations with Presentation Contexts for SOP Classes of the Verification, Storage, and Storage Commitment Service Classes. Any images received on such Presentation Contexts will be added to the EXAMPLE-QUERY-RETRIEVE-SERVER database. If a Storage Commitment Push Model N-ACTION Request is received then the STORAGE-COMMITMENT-SCP AE will immediately check if the referenced Composite SOP Instances are in the EXAMPLE-QUERY-RETRIEVE-SERVER database and return an N-EVENT-REPORT Notification. It will



never 'cache' Storage Commitment Push Model Requests and wait for Composite SOP Instances to be received at a later time.

### F.4.1.3 Sequencing of Real-World Activities

The only sequencing constraint that exists across all the EXAMPLE-QUERY-RETRIEVE-SERVER Application Entities is the fact that a Composite SOP Instance must be received by the STORAGE-SCP AE before Storage Commitment Push Model or Query-Retrieve Requests related to this SOP Instance can be successfully handled:



**Figure F.4.1-2  
SEQUENCING CONSTRAINTS**

Note that the only constraint is for the Composite SOP Instance to be received prior to the other events. For example, it is not necessary for the Storage Commitment Push Model Request to be received prior to receiving Query or Retrieval Requests related to the SOP Instance.

## F.4.2 AE SPECIFICATIONS

### F.4.2.1 STORAGE-SCU Application Entity Specification

#### F.4.2.1.1 SOP Classes

The STORAGE-SCU AE provides Standard Conformance to the following DICOM V3.0 SOP Classes:

**Table F.4.2-1  
SOP CLASSES FOR STORAGE-SCU AE**

| SOP Class Name                     | SOP Class UID               | SCU | SCP |
|------------------------------------|-----------------------------|-----|-----|
| Verification                       | 1.2.840.10008.1.1           | Yes | No  |
| US Image Storage (Retired)         | 1.2.840.10008.5.1.4.1.1.6   | Yes | No  |
| US Image Storage                   | 1.2.840.10008.5.1.4.1.1.6.1 | Yes | No  |
| US Multi-frame Storage (Retired)   | 1.2.840.10008.5.1.4.1.1.3   | Yes | No  |
| US Multi-frame Storage             | 1.2.840.10008.5.1.4.1.1.3.1 | Yes | No  |
| Computed Radiography Image Storage | 1.2.840.10008.5.1.4.1.1.1   | Yes | No  |
| CT Image Storage                   | 1.2.840.10008.5.1.4.1.1.2   | Yes | No  |
| MR Image Storage                   | 1.2.840.10008.5.1.4.1.1.4   | Yes | No  |
| Secondary Capture Image Storage    | 1.2.840.10008.5.1.4.1.1.7   | Yes | No  |

STORAGE-SCU AE can be configured to use the retired US Image objects (US Image Storage, 1.2.840.10008.5.1.4.1.1.6, and US Multi-frame Storage, 1.2.840.10008.5.1.4.1.1.3) rather than the current US SOP Classes for ultrasound images or vice-versa, making any necessary changes to make the transformed image objects conformant to the corresponding SOP Class. This is only done if the external Storage SCP AE does not support the SOP Instance's original SOP Class.

By altering the configuration it is possible to support additional or fewer SOP Classes.

#### F.4.2.1.2 Association Establishment Policies

##### F.4.2.1.2.1 General

The STORAGE-SCU AE can only form Associations when requested to do so by the QUERY-RETRIEVE-SCP AE. The STORAGE-SCU AE can only request the opening of an Association. It cannot accept requests to open Associations from external Application Entities.

The DICOM standard Application Context Name for DICOM is always proposed:

**Table F.4.2-2  
DICOM APPLICATION CONTEXT FOR STORAGE-SCU AE**

|                          |                       |
|--------------------------|-----------------------|
| Application Context Name | 1.2.840.10008.3.1.1.1 |
|--------------------------|-----------------------|

##### F.4.2.1.2.2 Number of Associations

The maximum number of simultaneous Associations is configurable, but is usually limited to a maximum of 10. This configuration largely depends on whether relatively quick response to multiple simultaneous C-MOVE Destination AE's is required or maximum throughput performance is required. If the latter is the case, then no simultaneous Associations are permitted, in order to reduce disk thrashing and thus maximize throughput. The STORAGE-SCU AE can initiate simultaneous Associations to a given external C-MOVE Destination AE up to the maximum number configured. There is no separate limit on the maximum number permitted to the same C-MOVE Destination AE.

If the first attempt to open an Association fails then the STORAGE-SCU AE will reschedule the task to attempt it again after a configurable time delay. The number of times to reattempt Association establishment is configurable, with the default being zero.

**Table F.4.2-3  
NUMBER OF ASSOCIATIONS AS A SCU FOR STORAGE-SCU AE**

|                                             |                   |
|---------------------------------------------|-------------------|
| Maximum number of simultaneous Associations | 10 (Configurable) |
|---------------------------------------------|-------------------|

**F.4.2.1.2.3 Asynchronous Nature**

The STORAGE-SCU AE does not support asynchronous communication (multiple outstanding transactions over a single Association). All Association requests must be completed and acknowledged before a new operation can be initiated.

**Table F.4.2-4  
ASYNCHRONOUS NATURE AS A SCU FOR STORAGE-SCU AE**

|                                                         |                      |
|---------------------------------------------------------|----------------------|
| Maximum number of outstanding asynchronous transactions | 1 (Not Configurable) |
|---------------------------------------------------------|----------------------|

**F.4.2.1.2.4 Implementation Identifying Information**

**Table F.4.2-5  
DICOM IMPLEMENTATION CLASS AND VERSION FOR STORAGE-SCU AE**

|                             |                         |
|-----------------------------|-------------------------|
| Implementation Class UID    | 1.840.xxxxxx.yyy.etc... |
| Implementation Version Name | EX_VERS_01              |

Note that the STORAGE-SCU AE and QUERY-RETRIEVE-SCP AE use the same Implementation Class UID. All EXAMPLE-QUERY-RETRIEVE-SERVER AE's use the same Implementation Version Name. This Version Name is updated with each new release of the product software, as the different AE versions are never released independently.

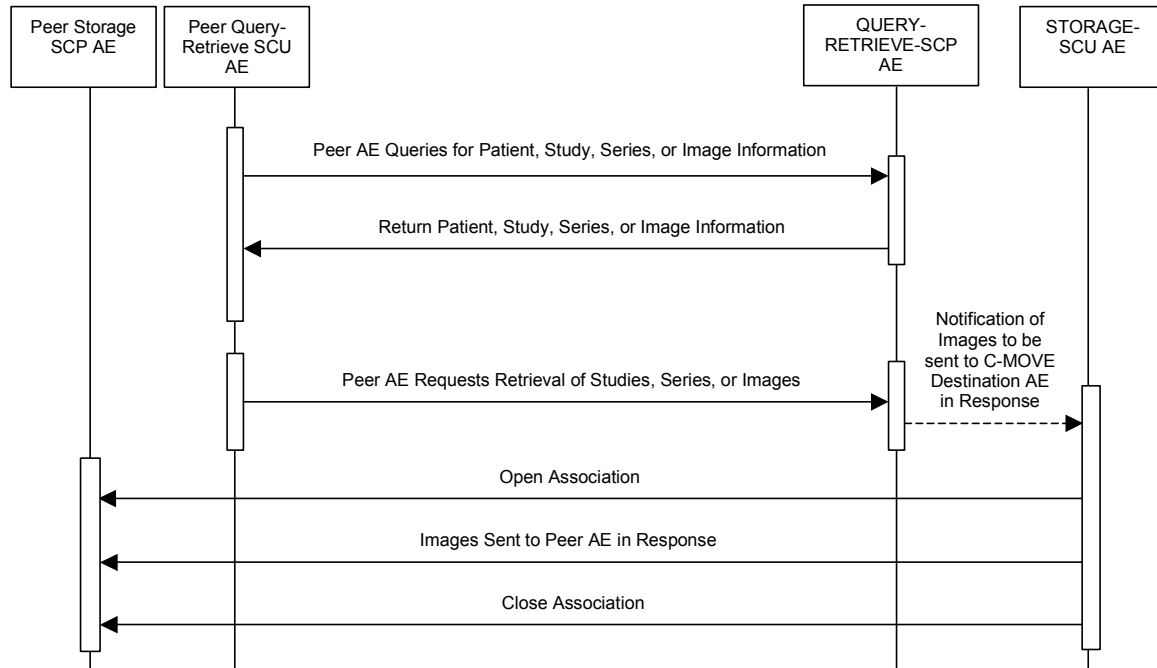
**F.4.2.1.3 Association Initiation Policy**

**F.4.2.1.3.1 Activity – Send Images Requested by an External Peer AE**

**F.4.2.1.3.1.1 Description and Sequencing of Activity**

The STORAGE-SCU AE will initiate a new Association when the QUERY-RETRIEVE-SCP AE invokes the STORAGE-SCU AE to transmit images. The QUERY-RETRIEVE-SCP AE will issue such a command whenever it receives a valid C-MOVE Request. An Association Request is sent to the specified C-MOVE Destination AE and upon successful negotiation of the required Presentation Context the image transfer is started. In all cases an attempt will be made to transmit all the indicated images in a single Association, but this may not always be possible. The Association will be released when all the images have been sent. If an error occurs during transmission over an open Association then the image transfer is halted. The STORAGE-SCU AE will not attempt to independently retry the image export.

Note that the STORAGE-SCU AE does not support the unsolicited sending of SOP Instances using the DICOM Storage Service Class. It will only send SOP Instances in response to a C-MOVE Request from a peer AE.



**Figure F.4.2-1**  
**SEQUENCING OF ACTIVITY - SEND IMAGES REQUESTED BY AN EXTERNAL PEER AE**

The following sequencing constraints illustrated in Figure F.4.2-1 apply to the STORAGE-SCU AE:

1. Peer AE requests retrieval of Study, Series, or Images from QUERY-RETRIEVE-SCP AE (C-MOVE-RQ).
2. QUERY-RETRIEVE-SCP AE signals STORAGE-SCU AE to send the image Composite SOP Instances indicated in the C-MOVE-RQ to the C-MOVE Destination AE.
3. STORAGE-SCU AE opens a new Association with the indicated C-MOVE Destination AE.
4. STORAGE-SCU AE sends the indicated Composite SOP Instances.
5. STORAGE-SCU AE closes the Association.
6. The Verification Service is only supported as a utility function for Service staff. It is used only as a diagnostic tool.

**F.4.2.1.3.1.2 Proposed Presentation Contexts**

STORAGE-SCU AE will propose Presentation Contexts as shown in the following table:

**Table F.4.2-6**  
**PROPOSED PRESENTATION CONTEXTS BY THE STORAGE-SCU AE**

| Presentation Context Table         |                             |                                                |                        |      |           |
|------------------------------------|-----------------------------|------------------------------------------------|------------------------|------|-----------|
| Abstract Syntax                    |                             | Transfer Syntax                                |                        | Role | Ext. Neg. |
| Name                               | UID                         | Name                                           | UID                    |      |           |
| Verification                       | 1.2.840.10008.1.1           | DICOM Implicit VR Little Endian                | 1.2.840.10008.1.2      | SCU  | None      |
| US Image Storage (Retired)         | 1.2.840.10008.5.1.4.1.1.6   | DICOM Implicit VR Little Endian                | 1.2.840.10008.1.2      | SCU  | None      |
| US Image Storage (Retired)         | 1.2.840.10008.5.1.4.1.1.6   | DICOM Explicit VR Little Endian                | 1.2.840.10008.1.2.1    | SCU  | None      |
| US Image Storage (Retired)         | 1.2.840.10008.5.1.4.1.1.6   | DICOM Explicit JPEG baseline lossy compression | 1.2.840.10008.1.2.4.50 | SCU  | None      |
| US Image Storage                   | 1.2.840.10008.5.1.4.1.1.6.1 | DICOM Implicit VR Little Endian                | 1.2.840.10008.1.2      | SCU  | None      |
| US Image Storage                   | 1.2.840.10008.5.1.4.1.1.6.1 | DICOM Explicit VR Little Endian                | 1.2.840.10008.1.2.1    | SCU  | None      |
| US Image Storage                   | 1.2.840.10008.5.1.4.1.1.6.1 | DICOM Explicit JPEG baseline lossy compression | 1.2.840.10008.1.2.4.50 | SCU  | None      |
| US Multi-frame Storage (Retired)   | 1.2.840.10008.5.1.4.1.1.3   | DICOM Implicit VR Little Endian                | 1.2.840.10008.1.2      | SCU  | None      |
| US Multi-frame Storage (Retired)   | 1.2.840.10008.5.1.4.1.1.3   | DICOM Explicit VR Little Endian                | 1.2.840.10008.1.2.1    | SCU  | None      |
| US Multi-frame Storage (Retired)   | 1.2.840.10008.5.1.4.1.1.3   | DICOM Explicit JPEG baseline lossy compression | 1.2.840.10008.1.2.4.50 | SCU  | None      |
| US Multi-frame Storage             | 1.2.840.10008.5.1.4.1.1.3.1 | DICOM Implicit VR Little Endian                | 1.2.840.10008.1.2      | SCU  | None      |
| US Multi-frame Storage             | 1.2.840.10008.5.1.4.1.1.3.1 | DICOM Explicit VR Little Endian                | 1.2.840.10008.1.2.1    | SCU  | None      |
| US Multi-frame Storage             | 1.2.840.10008.5.1.4.1.1.3.1 | DICOM Explicit JPEG baseline lossy compression | 1.2.840.10008.1.2.4.50 | SCU  | None      |
| Computer Radiography Image Storage | 1.2.840.10008.5.1.4.1.1.1   | DICOM Implicit VR Little Endian                | 1.2.840.10008.1.2      | SCU  | None      |
| Computer Radiography Image Storage | 1.2.840.10008.5.1.4.1.1.1   | DICOM Explicit VR Little Endian                | 1.2.840.10008.1.2.1    | SCU  | None      |
| CT Image Storage                   | 1.2.840.10008.5.1.4.1.1.2   | DICOM Implicit VR Little Endian                | 1.2.840.10008.1.2      | SCU  | None      |

| Presentation Context Table      |                           |                                                |                        |     |      |
|---------------------------------|---------------------------|------------------------------------------------|------------------------|-----|------|
| Abstract Syntax                 |                           | Transfer Syntax                                |                        |     |      |
| CT Image Storage                | 1.2.840.10008.5.1.4.1.1.2 | DICOM Explicit VR Little Endian                | 1.2.840.10008.1.2.1    | SCU | None |
| MR Image Storage                | 1.2.840.10008.5.1.4.1.1.4 | DICOM Implicit VR Little Endian                | 1.2.840.10008.1.2      | SCU | None |
| MR Image Storage                | 1.2.840.10008.5.1.4.1.1.4 | DICOM Explicit VR Little Endian                | 1.2.840.10008.1.2.1    | SCU | None |
| Secondary Capture Image Storage | 1.2.840.10008.5.1.4.1.1.7 | DICOM Implicit VR Little Endian                | 1.2.840.10008.1.2      | SCU | None |
| Secondary Capture Image Storage | 1.2.840.10008.5.1.4.1.1.7 | DICOM Explicit VR Little Endian                | 1.2.840.10008.1.2.1    | SCU | None |
| Secondary Capture Image Storage | 1.2.840.10008.5.1.4.1.1.7 | DICOM Explicit JPEG baseline lossy compression | 1.2.840.10008.1.2.4.50 | SCU | None |

Note: The SOP Classes and Transfer Syntaxes that the STORAGE-SCU AE proposes, as listed above, represent the default behavior. The STORAGE-SCU AE can be configured to propose a subset of these contexts or additional Presentation Contexts. Also, the default Behavior is to propose just a single Transfer Syntax per Presentation Context. However, this can be altered so that every proposed Presentation Context has a unique SOP Class and one or more Transfer Syntaxes. That is, the default behavior is to determine the Transfer Syntaxes the SCP can accept as opposed to which it prefers.

#### F.4.2.1.3.1.3 SOP Specific Conformance for Verification SOP Class

Standard conformance is provided to the DICOM Verification Service Class as an SCU. The Verification Service as an SCU is actually only supported as a diagnostic service tool for network communication issues.

#### F.4.2.1.3.1.4 SOP Specific Conformance for Image SOP Classes

Composite DICOM SOP Instances are maintained as DICOM Part 10 compliant files in the EXAMPLE-QUERY-RETRIEVE-SERVER database. The entire set of tags received with the image will be saved in EXAMPLE-QUERY-RETRIEVE-SERVER; this includes all Private and SOP Extended Elements. When a SOP Instance is selected for export from EXAMPLE-QUERY-RETRIEVE-SERVER, its content will be exported as it was originally received except for a few possible exceptions. Some of the Patient demographic and Study information Elements whose values can have been altered due to changes administered on EXAMPLE-QUERY-RETRIEVE-SERVER or changes to the state of the image data due to compression can be altered when the SOP Instance is exported.

The Patient demographic and Study information can be entered or altered by several means: manually, or from HL7 messaging,. The replacement behavior depends on which specific DICOM and HL7 services are supported. Also, this behavior is configurable. Values can be altered without changing the SOP Instance UID unless otherwise noted. Refer to the Annex for the specific details of which Elements can have their values altered at time of export.

The EXAMPLE-QUERY-RETRIEVE-SERVER creates files called Service Logs that can be used to monitor their status and diagnose any problems that may arise. If any error occurs during DICOM

communication then appropriate messages are always output to these Service Logs. In addition, error messages may be output as alerts to the User Interface in certain cases.

The STORAGE-SCU AE will exhibit the following Behavior according to the Status Code value returned in a C-STORE Response from a destination C-STORE SCP:

**Table F.4.2-7  
STORAGE-SCU AE C-STORE RESPONSE STATUS HANDLING BEHAVIOR**

| <b>Service Status</b> | <b>Further Meaning</b>            | <b>Error Code</b> | <b>Behavior</b>                                                                                                                                                                                                                                                                                                                                           |
|-----------------------|-----------------------------------|-------------------|-----------------------------------------------------------------------------------------------------------------------------------------------------------------------------------------------------------------------------------------------------------------------------------------------------------------------------------------------------------|
| Success               | Success                           | 0000              | The SCP has successfully stored the exported SOP Instance. A message is sent to the QUERY-RETRIEVE-SCP AE indicating successful export. The QUERY-RETRIEVE-SCP AE will send the appropriate PENDING or SUCCESS Status in the C-MOVE Response.<br>Success indication message is output to the Service Logs.<br>No message is posted to the User Interface. |
| Refused               | Out of Resources                  | A700 – A7FF       | This is treated as a permanent Failure. A message is sent to the QUERY-RETRIEVE-SCP AE indicating an export failure and the Association is released. The QUERY-RETRIEVE-SCP AE will send an appropriate Status in the C-MOVE Response.<br>Error indication message is output to the Service Logs.<br>No message is posted to the User Interface.          |
| Error                 | Data Set does not match SOP Class | A900 – A9FF       | This is treated as a permanent Failure. A message is sent to the QUERY-RETRIEVE-SCP AE indicating an export failure and the Association is released. The QUERY-RETRIEVE-SCP AE will send an appropriate Status in the C-MOVE Response.<br>Error indication message is output to the Service Logs.<br>No message is posted to the User Interface.          |
| Error                 | Cannot Understand                 | C000 - CFFF       | This is treated as a permanent Failure. A message is sent to the QUERY-RETRIEVE-SCP AE indicating an export failure and the Association is released. The QUERY-RETRIEVE-SCP AE will send an appropriate Status in the C-MOVE Response.<br>Error indication message is output to the Service Logs.<br>No message is posted to the User Interface.          |
| Warning               | Coercion of Data Elements         | B000              | Image transmission is considered successful. A message is sent to the QUERY-RETRIEVE-SCP AE indicating successful export. The QUERY-RETRIEVE-SCP AE will send the appropriate PENDING or SUCCESS Status in the C-MOVE Response.<br>Warning indication message is output to the Service Logs.<br>No message is posted to the User Interface.               |
| Warning               | Data Set does not match SOP Class | B007              | Image transmission is considered successful. A message is sent to the QUERY-RETRIEVE-SCP AE indicating successful export. The QUERY-RETRIEVE-SCP AE will send the appropriate PENDING or SUCCESS Status in the C-MOVE Response.<br>Warning indication message is output to the Service Logs.                                                              |

|         |                              |                        |                                                                                                                                                                                                                                                                                                                                                      |
|---------|------------------------------|------------------------|------------------------------------------------------------------------------------------------------------------------------------------------------------------------------------------------------------------------------------------------------------------------------------------------------------------------------------------------------|
|         |                              |                        | No message is posted to the User Interface.                                                                                                                                                                                                                                                                                                          |
| Warning | Elements Discarded           | B006                   | Image transmission is considered successful. A message is sent to the QUERY-RETRIEVE-SCP AE indicating successful export. The QUERY-RETRIEVE-SCP AE will send the appropriate PENDING or SUCCESS Status in the C-MOVE Response.<br><br>Warning indication message is output to the Service Logs.<br>No message is posted to the User Interface.      |
| Warning | Attribute List Error         | 0107                   | Image transmission is considered successful. A message is sent to the QUERY-RETRIEVE-SCP AE indicating successful export. The QUERY-RETRIEVE-SCP AE will send the appropriate PENDING or SUCCESS Status in the C-MOVE Response.<br><br>Warning indication message is output to the Service Logs.<br>No message is posted to the User Interface.      |
| Warning | Attribute Value Out of Range | 0116                   | Image transmission is considered successful. A message is sent to the QUERY-RETRIEVE-SCP AE indicating successful export. The QUERY-RETRIEVE-SCP AE will send the appropriate PENDING or SUCCESS Status in the C-MOVE Response.<br><br>Warning indication message is output to the Service Logs.<br>No message is posted to the User Interface.      |
| *       | *                            | Any other status code. | This is treated as a permanent Failure. A message is sent to the QUERY-RETRIEVE-SCP AE indicating an export failure and the Association is released. The QUERY-RETRIEVE-SCP AE will send an appropriate Status in the C-MOVE Response.<br><br>Error indication message is output to the Service Logs.<br>No message is posted to the User Interface. |

All Status Codes indicating an error or refusal are treated as a permanent failure. The STORAGE-SCU AE never automatically resends images when an error Status Code is returned in a C-STORE Response. For specific behavior regarding Status Code values returned in C-MOVE Responses, refer to the Services Supported as an SCP by the QUERY-RETRIEVE-SCP AE.

**Table F.4.2-8  
STORAGE-SCU AE COMMUNICATION FAILURE BEHAVIOR**

| <b>Exception</b>                                                             | <b>Behavior</b>                                                                                                                                                                                                     |
|------------------------------------------------------------------------------|---------------------------------------------------------------------------------------------------------------------------------------------------------------------------------------------------------------------|
| Timeout expiry for an expected DICOM Message Response (DIMSE level timeout). | The Association is aborted using a DICOM A-ABORT and a message is sent to the QUERY-RETRIEVE-SCP AE indicating an export failure. The QUERY-RETRIEVE-SCP AE will send an appropriate Status in the C-MOVE Response. |



|                                                                                                                           |                                                                                                                                                                                                                                                                                                                                   |
|---------------------------------------------------------------------------------------------------------------------------|-----------------------------------------------------------------------------------------------------------------------------------------------------------------------------------------------------------------------------------------------------------------------------------------------------------------------------------|
|                                                                                                                           | Error indication message is output to the Service Logs.<br>No message is posted to the User Interface.                                                                                                                                                                                                                            |
| Timeout expiry for an expected DICOM PDU or TCP/IP packet (Low-level timeout).                                            | The Association is aborted using a DICOM A-ABORT and a message is sent to the QUERY-RETRIEVE-SCP AE indicating an export failure. The QUERY-RETRIEVE-SCP AE will send an appropriate Status in the C-MOVE Response.<br><br>Error indication message is output to the Service Logs.<br>No message is posted to the User Interface. |
| Association A-ABORTed by the SCP or the network layers indicate communication loss (i.e. low-level TCP/IP socket closure) | A message is sent to the QUERY-RETRIEVE-SCP AE indicating an export failure. The QUERY-RETRIEVE-SCP AE will send an appropriate Status in the C-MOVE Response.<br><br>Error indication message is output to the Service Logs.<br>No message is posted to the User Interface.                                                      |

#### F.4.2.1.4 Association Acceptance Policy

The STORAGE-SCU AE does not accept Associations.

#### F.4.2.2 QUERY-RETRIEVE-SCP Application Entity Specification

##### F.4.2.2.1 SOP Classes

The QUERY-RETRIEVE-SCP AE provides Standard Conformance to the following DICOM V3.0 SOP Classes:

**Table F.4.2-9  
SOP CLASSES FOR QUERY-RETRIEVE-SCP AE**

| SOP Class Name                            | SOP Class UID               | SCU | SCP |
|-------------------------------------------|-----------------------------|-----|-----|
| Patient Root Q/R Information Model - FIND | 1.2.840.10008.5.1.4.1.2.1.1 | No  | Yes |
| Patient Root Q/R Information Model - MOVE | 1.2.840.10008.5.1.4.1.2.1.2 | No  | Yes |
| Study Root Q/R Information Model - FIND   | 1.2.840.10008.5.1.4.1.2.2.1 | No  | Yes |
| Study Root Q/R Information Model - MOVE   | 1.2.840.10008.5.1.4.1.2.2.2 | No  | Yes |

##### F.4.2.2.2 Association Policies

###### F.4.2.2.2.1 General

The QUERY-RETRIEVE-SCP AE will never initiate Associations; it only accepts Association Requests from external DICOM AEs. The QUERY-RETRIEVE-SCP AE will accept Associations for Verification, C-FIND, and C-MOVE requests. In the case of a C-MOVE request, the QUERY-RETRIEVE-SCP AE will issue a command to the STORAGE-SCU AE to initiate an Association with the Destination DICOM AE to send images as specified by the originator of the C-MOVE Request.

The DICOM standard Application Context Name for DICOM 3.0 is always accepted:

**Table F.4.2-10  
DICOM APPLICATION CONTEXT FOR QUERY-RETRIEVE-SCP AE**

|                          |                       |
|--------------------------|-----------------------|
| Application Context Name | 1.2.840.10008.3.1.1.1 |
|--------------------------|-----------------------|

**F.4.2.2.2 Number of Associations**

The QUERY-RETRIEVE-SCP AE can support multiple simultaneous Associations. Each time the QUERY-RETRIEVE-SCP AE receives an Association, a child process will be spawned to process the Verification, Query, or Retrieval request. The maximum number of child processes, and thus the maximum number of simultaneous Associations that can be processed, is set by configuration. The default maximum is 10 in total. The maximum number of simultaneous Associations can be either an absolute number or a maximum number for each requesting external Application Entity. The latter flexibility can be useful if communication with one external AE is unreliable and one does not wish 'hung' connections with this AE to prevent Associations with other client AEs.

**Table F.4.2-11  
NUMBER OF SIMULTANEOUS ASSOCIATIONS AS A SCP FOR QUERY-RETRIEVE-SCP AE**

|                                             |                   |
|---------------------------------------------|-------------------|
| Maximum number of simultaneous Associations | 10 (Configurable) |
|---------------------------------------------|-------------------|

**F.4.2.2.3 Asynchronous Nature**

The QUERY-RETRIEVE-SCP AE does not support asynchronous communication (multiple outstanding transactions over a single Association). All Association requests must be completed and acknowledged before a new operation can be initiated.

**Table F.4.2-12  
ASYNCHRONOUS NATURE AS A SCP FOR QUERY-RETRIEVE-SCP AE**

|                                                         |                      |
|---------------------------------------------------------|----------------------|
| Maximum number of outstanding asynchronous transactions | 1 (Not Configurable) |
|---------------------------------------------------------|----------------------|

**F.4.2.2.4 Implementation Identifying Information**

The implementation information for the Application Entity is:

**Table F.4.2-13  
DICOM IMPLEMENTATION CLASS AND VERSION FOR QUERY-RETRIEVE-SCP AE**

|                             |                          |
|-----------------------------|--------------------------|
| Implementation Class UID    | 1.840.xxxxxxx.yyy.etc... |
| Implementation Version Name | EX_VERS_01               |

Note that the STORAGE-SCU AE, and QUERY-RETRIEVE-SCP AE use the same Implementation Class UID. All EXAMPLE-QUERY-RETRIEVE-SERVER AE's use the same Implementation Version Name. This Version Name is updated with each new release of the product software, as the different AE versions are never released independently.

**F.4.2.2.3 Association Initiation Policy**

The QUERY-RETRIEVE-SCP AE does not initiate Associations.

**F.4.2.2.4 Association Acceptance Policy**

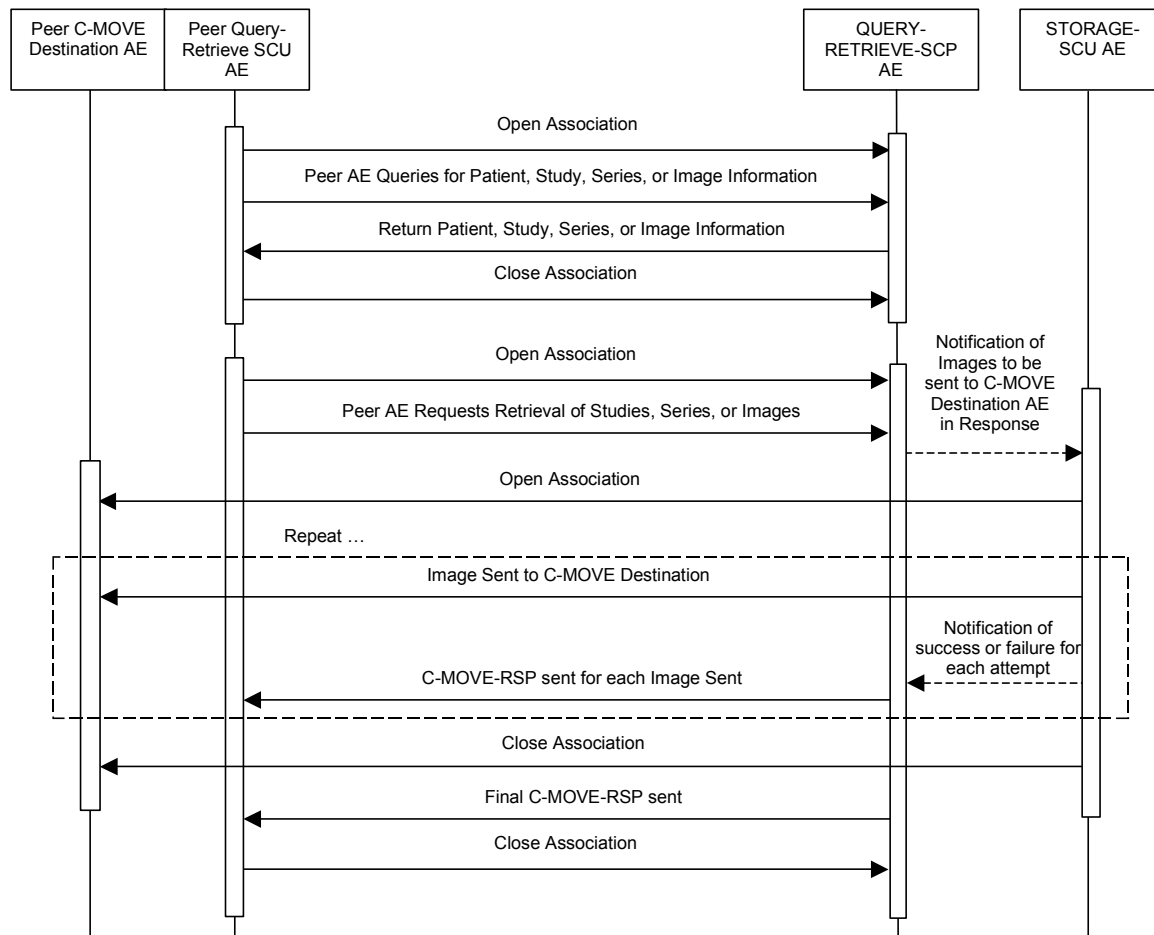
**F.4.2.2.4.1 Activity – Handling Query and Retrieval Requests**

**F.4.2.2.4.1.1 Description and Sequencing of Activity**

The QUERY-RETRIEVE-SCP AE accepts Associations only if they have valid Presentation Contexts. If none of the requested Presentation Contexts are accepted then the Association Request itself is rejected. It can be configured to only accept Associations with certain hosts (using TCP/IP address) and/or Application Entity Titles.

If QUERY-RETRIEVE-SCP AE receives a query (C-FIND) request then the response(s) will be sent over the same Association used to send the C-FIND-Request.

If QUERY-RETRIEVE-SCP AE receives a retrieval (C-MOVE) request then the responses will be sent over the same Association used to send the C-MOVE-Request. The QUERY-RETRIEVE-SCP AE will notify the STORAGE-SCU AE to send the requested SOP Instances to the C-MOVE Destination. The STORAGE-SCU AE notifies the QUERY-RETRIEVE-SCP AE of the success or failure of each attempt to send a Composite SOP Instance to the peer C-MOVE Destination AE. The QUERY-RETRIEVE-SCP AE then sends a C-MOVE Response indicating this status after each attempt. Once the STORAGE-SCU AE has finished attempting to transfer all the requested SOP Instances, the QUERY-RETRIEVE-SCP AE sends a final C-MOVE Response indicating the overall status of the attempted retrieval.



**Figure F.4.2-2**  
**SEQUENCING OF ACTIVITY – HANDLING QUERY AND RETRIEVAL REQUESTS**

The following sequencing constraints illustrated in Figure F.4.2-2 apply to the QUERY-RETRIEVE-SCP AE for handling queries (C-FIND-Requests):

1. Peer AE opens an Association with the QUERY-RETRIEVE-SCP AE.
2. Peer AE sends a C-FIND-RQ Message

3. QUERY-RETRIEVE-SCP AE returns a C-FIND-RSP Message to the peer AE with matching information. A C-FIND-RSP is sent for each entity matching the identifier specified in the C-FIND-RQ. A final C-FIND-RSP is sent indicating that the matching is complete.
4. Peer AE closes the Association. Note that the peer AE does not have to close the Association immediately. Further C-FIND or C-MOVE Requests can be sent over the Association before it is closed.

The following sequencing constraints illustrated in Figure F.4.2-2 apply to the QUERY-RETRIEVE-SCP AE for handling retrievals (C-MOVE-Requests):

1. Peer AE opens an Association with the QUERY-RETRIEVE-SCP AE.
2. Peer AE sends a C-MOVE-RQ Message
3. QUERY-RETRIEVE-SCP AE notifies the STORAGE-SCU AE to send the Composite SOP Instances to the peer C-MOVE Destination AE as indicated in the C-MOVE-RQ.
4. After attempting to send a SOP Instance, the STORAGE-SCU AE indicates to the QUERY-RETRIEVE-SCP AE whether the transfer succeeded or failed. The QUERY-RETRIEVE-SCP AE then returns a C-MOVE-RSP indicating this success or failure.
5. Once the STORAGE-SCU AE has completed all attempts to transfer the SOP Instances to the C-MOVE Destination AE, or the first failure occurred, the QUERY-RETRIEVE-SCP AE sends a final C-MOVE-RSP indicating the overall success or failure of the retrieval.
6. Peer AE closes the Association. Note that the peer AE does not have to close the Association immediately. Further C-FIND or C-MOVE Requests can be sent over the Association before it is closed.

The QUERY-RETRIEVE-SCP AE may reject Association attempts as shown in the table below. The Result, Source and Reason/Diag columns represent the values returned in the corresponding fields of an ASSOCIATE-RJ PDU (see PS 3.8, Section 9.3.4). The following abbreviations are used in the Source column:

- a. 1 – DICOM UL service-user
- b. 2 – DICOM UL service-provider (ASCE related function)
- c. 3 – DICOM UL service-provider (Presentation related function)

**Table F.4.2-14**  
**ASSOCIATION REJECTION REASONS**

| Result                 | Source | Reason/Diag              | Explanation                                                                                                                                                                                                                                                                                                                                   |
|------------------------|--------|--------------------------|-----------------------------------------------------------------------------------------------------------------------------------------------------------------------------------------------------------------------------------------------------------------------------------------------------------------------------------------------|
| 2 – rejected-transient | c      | 2 – local-limit-exceeded | The (configurable) maximum number of simultaneous Associations has been reached. An Association request with the same parameters may succeed at a later time.                                                                                                                                                                                 |
| 2 – rejected-transient | c      | 1 – temporary-congestion | No Associations can be accepted at this time due to the real-time requirements of higher priority activities (e.g. during image acquisition no Associations will be accepted) or because insufficient resources are available (e.g. memory, processes, threads). An Association request with the same parameters may succeed at a later time. |

|                        |   |                                            |                                                                                                                                                                                                                                                                                                                                                                      |
|------------------------|---|--------------------------------------------|----------------------------------------------------------------------------------------------------------------------------------------------------------------------------------------------------------------------------------------------------------------------------------------------------------------------------------------------------------------------|
| 1 – rejected-permanent | a | 2 – application-context-name-not-supported | The Association request contained an unsupported Application Context Name. An association request with the same parameters will not succeed at a later time.                                                                                                                                                                                                         |
| 1 – rejected-permanent | a | 7 – called-AE-title-not-recognized         | The Association request contained an unrecognized Called AE Title. An Association request with the same parameters will not succeed at a later time unless configuration changes are made. This rejection reason normally occurs when the Association initiator is incorrectly configured and attempts to address the Association acceptor using the wrong AE Title. |
| 1 – rejected-permanent | a | 3 – calling-AE-title-not-recognized        | The Association request contained an unrecognized Calling AE Title. An Association request with the same parameters will not succeed at a later time unless configuration changes are made. This rejection reason normally occurs when the Association acceptor has not been configured to recognize the AE Title of the Association initiator.                      |
| 1 – rejected-permanent | b | 1 – no-reason-given                        | The Association request could not be parsed. An Association request with the same format will not succeed at a later time.                                                                                                                                                                                                                                           |

#### F.4.2.2.4.1.2 Accepted Presentation Contexts

QUERY-RETRIEVE-SCP AE will accept Presentation Contexts as shown in the following table:

**Table F.4.2-15**  
**ACCEPTED PRESENTATION CONTEXTS BY THE QUERY-RETRIEVE-SCP AE**

| Presentation Context Table                |                             |                                 |                   |      |           |
|-------------------------------------------|-----------------------------|---------------------------------|-------------------|------|-----------|
| Abstract Syntax                           |                             | Transfer Syntax                 |                   | Role | Ext. Neg. |
| Name                                      | UID                         | Name                            | UID               |      |           |
| Verification                              | 1.2.840.10008.1.1           | DICOM Implicit VR Little Endian | 1.2.840.10008.1.2 | SCP  | None      |
| Patient Root Q/R Information Model - FIND | 1.2.840.10008.5.1.4.1.2.1.1 | DICOM Implicit VR Little Endian | 1.2.840.10008.1.2 | SCP  | None      |
| Patient Root Q/R Information Model - MOVE | 1.2.840.10008.5.1.4.1.2.1.2 | DICOM Implicit VR Little Endian | 1.2.840.10008.1.2 | SCP  | None      |
| Study Root Q/R Information Model - FIND   | 1.2.840.10008.5.1.4.1.2.2.1 | DICOM Implicit VR Little Endian | 1.2.840.10008.1.2 | SCP  | None      |
| Study Root Q/R Information Model - MOVE   | 1.2.840.10008.5.1.4.1.2.2.2 | DICOM Implicit VR Little Endian | 1.2.840.10008.1.2 | SCP  | None      |

#### F.4.2.2.4.1.3 SOP Specific Conformance for Query SOP Classes

The QUERY-RETRIEVE-SCP AE supports hierarchical queries and not relational queries. There are no attributes always returned by default. Only those attributes requested in the query identifier are returned. Query responses always return values from the EXAMPLE-QUERY-RETRIEVE-SERVER database. Exported SOP Instances are always updated with the latest values in the database prior to export. Thus,

a change in Patient demographic information will be contained in both the C-FIND Responses and any Composite SOP Instances exported to a C-MOVE Destination AE.

Patient Root Information Model

All required search keys on each of the four levels (Patient, Study, Series, and Image) are supported. However, the Patient ID (0010,0020) key must have at least a partial value if the Patient's Name (0010,0010) is not present in a Patient Level query.

Study Root Information Model

All the required search keys on each of the three levels (Study, Series, and Image) are supported. If no partial values are specified for Study attributes then either the Patient ID (0010,0020) key or the Patient's Name (0010,0010) must have at least a partial value specified.

**Table F.4.2-16  
PATIENT ROOT C-FIND SCP SUPPORTED ELEMENTS**

| Level Name<br>Attribute Name         | Tag       | VR | Types of<br>Matching |
|--------------------------------------|-----------|----|----------------------|
| SOP Common<br>Specific Character Set | 0008,0005 | CS | NONE                 |
| Patient Level<br>Patient's Name      | 0010,0010 | PN | S,*,U                |
| Patient ID                           | 0010,0020 | LO | S,*,U                |
| Patient's Birth Date                 | 0010,0030 | DA | S,U                  |
| Patient's Sex                        | 0010,0040 | CS | S,U                  |
| Other Patient IDs                    | 0010,1000 | LO | NONE                 |
| Other Patient Names                  | 0010,1001 | PN | NONE                 |
| Study Level<br>Study Date            | 0008,0020 | DA | S,R,U                |
| Study Time                           | 0008,0030 | TM | R,U                  |
| Accession Number                     | 0008,0050 | SH | S,*,U                |
| Study ID                             | 0020,0010 | SH | S,*,U                |
| Study Instance UID                   | 0020,000D | UI | S,U,L                |
| Referring Physician's Name           | 0008,0090 | PN | S,*,U                |
| Study Description                    | 0008,1030 | LO | S,*,U                |
| Series Level<br>Modality             | 0008,0060 | CS | S,U                  |
| Series Number                        | 0020,0011 | IS | S,*,U                |
| Series Instance UID                  | 0020,000E | UI | S,U,L                |
| Operator's Name                      | 0008,1070 | PN | NONE                 |
| Image Level<br>Instance Number       | 0020,0013 | IS | S,*,U                |
| SOP Instance UID                     | 0008,0018 | UI | S,U,L                |

**Table F.4.2-17  
STUDY ROOT C-FIND SCP SUPPORTED ELEMENTS**

| Level Name<br>Attribute Name         | Tag       | VR | Types of<br>Matching |
|--------------------------------------|-----------|----|----------------------|
| SOP Common<br>Specific Character Set | 0008,0005 | CS | NONE                 |
| Study Level                          |           |    |                      |
| Patient's Name                       | 0010,0010 | PN | S,*,U                |
| Patient ID                           | 0010,0020 | LO | S,*,U                |
| Patient's Birth Date                 | 0010,0030 | DA | S,U                  |
| Patient's Sex                        | 0010,0040 | CS | S,U                  |
| Other Patient IDs                    | 0010,1000 | LO | NONE                 |
| Other Patient Names                  | 0010,1001 | PN | NONE                 |
| Study Date                           | 0008,0020 | DA | S,R,U                |
| Study Time                           | 0008,0030 | TM | R,U                  |
| Accession Number                     | 0008,0050 | SH | S,*,U                |
| Study ID                             | 0020,0010 | SH | S,*,U                |
| Study Instance UID                   | 0020,000D | UI | S,U,L                |
| Referring Physician's Name           | 0008,0090 | PN | S,*,U                |
| Study Description                    | 0008,1030 | LO | S,*,U                |
| Series Level                         |           |    |                      |
| Modality                             | 0008,0060 | CS | S,U                  |
| Series Number                        | 0020,0011 | IS | S,*,U                |
| Series Instance UID                  | 0020,000E | UI | S,U,L                |
| Operator's Name                      | 0008,1070 | PN | NONE                 |
| Image Level                          |           |    |                      |
| Instance Number                      | 0020,0013 | IS | S,*,U                |
| SOP Instance UID                     | 0008,0018 | UI | S,U,L                |

The tables should be read as follows:

- Attribute Name: Attributes supported for returned C-FIND Responses.
- Tag: Appropriate DICOM tag for this attribute.
- VR: Appropriate DICOM VR for this attribute.
- Types of Matching: The types of Matching supported by the C-FIND SCP. A "S" indicates the identifier attribute can specify Single Value Matching, a "R" will indicate Range Matching, a "\*" will denote wildcard matching, an 'U' will indicate universal matching, and 'L' will indicate that UID lists are supported for matching. "NONE" indicates that no matching is supported, but that values for this Element in the database can be returned.

**Table F.4.2-19  
QUERY-RETRIEVE-SCP AE C-FIND RESPONSE STATUS RETURN BEHAVIOR**

| <b>Service Status</b> | <b>Further Meaning</b>                                                   | <b>Error Code</b> | <b>Behavior</b>                                                                                                                                                                                                                                                                                              |
|-----------------------|--------------------------------------------------------------------------|-------------------|--------------------------------------------------------------------------------------------------------------------------------------------------------------------------------------------------------------------------------------------------------------------------------------------------------------|
| Success               | Success                                                                  | 0000              | Matching is complete. No final identifier is supplied.                                                                                                                                                                                                                                                       |
| Refused               | Out of Resources                                                         | A700              | System reached the limit in disk space or memory usage. Error message is output to as an alert to the User Interface, and to the Service Log.                                                                                                                                                                |
| Failed                | Identifier does not match SOP Class                                      | A900              | The C-FIND query identifier contains invalid Elements or values, or is missing mandatory Elements or values for the specified SOP Class. Error message is output to the Service Log.                                                                                                                         |
|                       | Unable to process                                                        | C001              | The C-FIND query identifier is valid for the specified SOP Class but cannot be used to query the database. For example, this can occur if a Patient Level query is issued but the identifier has only empty values for both the Patient ID and the Patient Name. Error message is output to the Service Log. |
| Cancel                | Matching terminated due to Cancel Request                                | FE00              | The C-FIND SCU sent a Cancel Request. This has been acknowledged and the search for matches has been halted.                                                                                                                                                                                                 |
| Pending               | Matches are continuing and current match is supplied.                    | FF00              | Indicates that the search for further matches is continuing. This is returned when each successful match is returned and when further matches are forthcoming. This status code is returned if all Optional keys in the query identifier are actually supported.                                             |
|                       | Matches are continuing but one or more Optional Keys were not supported. | FF01              | Indicates that the search for further matches is continuing. This is returned when each successful match is returned and when further matches are forthcoming. This status code is returned if there are Optional keys in the query identifier that are not supported.                                       |

**F.4.2.2.4.1.4 SOP Specific Conformance for Retrieval SOP Classes**

The QUERY-RETRIEVE-SCP AE will convey to the STORAGE-SCU AE that an Association with a DICOM Application Entity named by the external C-MOVE SCU (through a MOVE Destination AE Title) should be established. It will also convey to the STORAGE-SCU AE to perform C-STORE operations on specific images requested by the external C-MOVE SCU. One or more of the Image Storage Presentation Contexts listed in table F.4.2-6 will be negotiated.

The QUERY-RETRIEVE-SCP AE can support lists of UIDs in the C-MOVE Request at the Study, Series, and Image Levels. The list of UIDs must be at the Level of the C-MOVE Request however. For example, if the C-MOVE Request is for Series Level retrieval but the identifier contains a list of Study UIDs then the C-MOVE Request will be rejected, and the A900 Failed Status Code will be returned in the C-MOVE Response.

An initial C-MOVE Response is always sent after confirming that the C-MOVE Request itself can be processed. After this, the QUERY-RETRIEVE-SCP AE will return a response to the C-MOVE SCU after the STORAGE-SCU AE has attempted to send each image. This response reports the number of remaining SOP Instances to transfer, and the number transferred having a successful, failed, or warning status. If the Composite SOP Instances must be retrieved from long-term archive prior to export there



may be quite a long delay between the first C-MOVE Response and the next one after the attempt to export the first image. The maximum length of time for this delay will depend on the particular type of archive used but typically varies between 3 and 10 minutes.

**Table F.4.2-20**  
**QUERY-RETRIEVE-SCP AE C-MOVE RESPONSE STATUS RETURN BEHAVIOR**

| <b>Service Status</b> | <b>Further Meaning</b>                                   | <b>Error Code</b> | <b>Behavior</b>                                                                                                                                                                                                                                                                                                                                                                                         |
|-----------------------|----------------------------------------------------------|-------------------|---------------------------------------------------------------------------------------------------------------------------------------------------------------------------------------------------------------------------------------------------------------------------------------------------------------------------------------------------------------------------------------------------------|
| Success               | Sub-operations complete – No Failures                    | 0000              | All the Composite SOP Instances have been successfully sent to the C-MOVE Destination AE.                                                                                                                                                                                                                                                                                                               |
| Refused               | Out of Resources – Unable to calculate number of matches | A701              | Number of matches cannot be determined due to system failure. Returned if the server's database is not functioning so the search for matches to the C-MOVE Request cannot be found.<br><br>Error message is output as an alert on the User Interface, and to the Service Log.                                                                                                                           |
|                       | Out of Resources – Unable to perform sub-operations      | A702              | C-STORE sub-operations cannot be performed due to failure to access Composite SOP Instances in archive, or failure of a C-STORE Request. For example, this Status will be returned if the required SOP Instances are determined to be off-line (i.e. the MO media has been removed from the archive jukebox).<br><br>Error message is output as an alert on the User Interface, and to the Service Log. |
|                       | Move destination unknown                                 | A801              | The Destination Application Entity named in the C-MOVE Request is unknown to Query-Retrieve SCP AE.<br><br>Error message is output to the Service Log.                                                                                                                                                                                                                                                  |
| Failed                | Identifier does not match SOP Class                      | A900              | The C-MOVE identifier contains invalid Elements or values, or is missing mandatory Elements or values for the specified SOP Class or retrieval level.<br><br>Error message is output to the Service Log.                                                                                                                                                                                                |
| Cancel                | Matching terminated due to Cancel Request                | FE00              | The C-MOVE SCU sent a Cancel Request. This has been acknowledged and the export of Composite SOP Instances to the C-MOVE Destination AE has been halted.                                                                                                                                                                                                                                                |
| Pending               | Sub-operations are continuing                            | FF00              | A Response with this Status Code is sent every time a Composite SOP Instance has been successfully sent to the C-MOVE Destination AE.                                                                                                                                                                                                                                                                   |

Note that the Warning Status, B000 (Sub-operations complete – One or more Failures) is never returned. If a failure occurs during export to the C-MOVE Destination AE by the STORAGE-SCU AE then the entire task is aborted. Thus any remaining matches are not exported.

**Table F.4.2-21**  
**QUERY-RETRIEVE-SCP AE COMMUNICATION FAILURE BEHAVIOR**

| <b>Exception</b>                                                                                     | <b>Behavior</b>                                                                                           |
|------------------------------------------------------------------------------------------------------|-----------------------------------------------------------------------------------------------------------|
| Timeout expiry for an expected DICOM Message Request (DIMSE level timeout). I.e. The QUERY-RETRIEVE- | The Association is aborted by issuing a DICOM A-ABORT. Error message is output to the Service Log. If the |

|                                                                                                                                                                          |                                                                                                                                                                                                                                                                                                               |
|--------------------------------------------------------------------------------------------------------------------------------------------------------------------------|---------------------------------------------------------------------------------------------------------------------------------------------------------------------------------------------------------------------------------------------------------------------------------------------------------------|
| SCP AE is waiting for the next C-FIND or C-MOVE Request on an open Association but the timer expires.                                                                    | STORAGE-SCU AE is still exporting Composite SOP Instances as a result of an earlier C-MOVE Request received on this Association, it will continue attempting to complete the entire C-MOVE Request.                                                                                                           |
| Timeout expiry for an expected DICOM PDU or TCP/IP packet (Low-level timeout). I.e. The QUERY-RETRIEVE-SCP AE is waiting for the next message PDU but the timer expires. | The Association is aborted by issuing a DICOM A-ABORT. Error message is output to the Service Log. If the STORAGE-SCU AE is still exporting Composite SOP Instances as a result of an earlier C-MOVE Request received on this Association, it will continue attempting to complete the entire C-MOVE Request. |
| Association aborted by the SCU or the network layers indicate communication loss (i.e. low-level TCP/IP socket closure)                                                  | Error message is output to the Service Log. If the STORAGE-SCU AE is still exporting Composite SOP Instances as a result of an earlier C-MOVE Request received on this Association, it will continue attempting to complete the entire C-MOVE Request.                                                        |

### F.4.2.3 STORAGE-SCP Application Entity Specification

#### F.4.2.3.1 SOP Classes

The STORAGE-SCP AE provides Standard Conformance to the following DICOM V3.0 SOP Classes:

**Table F.4.2-22**  
**SOP CLASSES FOR STORAGE-SCP AE**

| SOP Class Name                     | SOP Class UID               | SCU | SCP |
|------------------------------------|-----------------------------|-----|-----|
| Verification                       | 1.2.840.10008.1.1           | Yes | Yes |
| Storage Commitment Push Model      | 1.2.840.10008.1.20.1        | No  | Yes |
| US Image Storage (Retired)         | 1.2.840.10008.5.1.4.1.1.6   | No  | Yes |
| US Image Storage                   | 1.2.840.10008.5.1.4.1.1.6.1 | No  | Yes |
| US Multi-frame Storage (Retired)   | 1.2.840.10008.5.1.4.1.1.3   | No  | Yes |
| US Multi-frame Storage             | 1.2.840.10008.5.1.4.1.1.3.1 | No  | Yes |
| Computed Radiography Image Storage | 1.2.840.10008.5.1.4.1.1.1   | No  | Yes |
| CT Image Storage                   | 1.2.840.10008.5.1.4.1.1.2   | No  | Yes |
| MR Image Storage                   | 1.2.840.10008.5.1.4.1.1.4   | No  | Yes |
| Secondary Capture Image Storage    | 1.2.840.10008.5.1.4.1.1.7   | No  | Yes |

These are the default SOP Classes supported. By altering the configuration it is possible to support additional or fewer SOP Classes.

#### F.4.2.3.2 Association Policies

##### F.4.2.3.2.1 General

The STORAGE-SCP AE can both accept and propose Association Requests. The STORAGE-SCP AE will accept Association Requests for the Verification, Storage, and Storage Commitment Push Model Services. It will propose Associations only for the Storage Commitment Push Model Service.

The DICOM standard Application Context Name for DICOM 3.0 is always accepted and proposed:

**Table F.4.2-23**  
**DICOM APPLICATION CONTEXT FOR STORAGE-SCP AE**

|                          |                       |
|--------------------------|-----------------------|
| Application Context Name | 1.2.840.10008.3.1.1.1 |
|--------------------------|-----------------------|

**F.4.2.3.2.2 Number of Associations**

The STORAGE-SCP AE can support multiple simultaneous Associations requested by peer AEs. Each time the STORAGE-SCP AE receives an Association, a child process will be spawned to process the Verification, Storage, or Storage Commitment Push Model Service requests. The maximum number of child processes, and thus the maximum number of simultaneous Associations that can be processed, is set by configuration. The default maximum number is 10 in total. This maximum number of simultaneous Associations can be either an absolute number or a maximum number for each requesting external Application Entity. The latter flexibility can be useful if communication with one external AE is unreliable and one does not wish 'hung' connections with this AE to prevent Associations with other client AEs.

The STORAGE-SCP AE initiates one Association at a time for sending Storage Commitment Push Model N-EVENT-REPORTs to peer AEs.

**Table F.4.2-24  
NUMBER OF SIMULTANEOUS ASSOCIATIONS AS AN SCP FOR STORAGE-SCP AE**

|                                                                        |                   |
|------------------------------------------------------------------------|-------------------|
| Maximum number of simultaneous Associations requested by peer AEs      | 10 (Configurable) |
| Maximum number of simultaneous Associations proposed by STORAGE-SCP AE | 1                 |

**F.4.2.3.2.3 Asynchronous Nature**

The STORAGE-SCP AE does not support asynchronous communication (multiple outstanding transactions over a single Association). The STORAGE-SCP AE does permit an SCU to send multiple Storage Commitment Push Model Requests before it has sent back any N-EVENT-REPORT Notifications. However, the STORAGE-SCP AE must send an N-ACTION Response before permitting another N-ACTION Request to be received so the DICOM communication itself is not truly asynchronous.

**Table F.4.2-25  
ASYNCHRONOUS NATURE AS A SCP FOR STORAGE-SCP AE**

|                                                         |                      |
|---------------------------------------------------------|----------------------|
| Maximum number of outstanding asynchronous transactions | 1 (Not Configurable) |
|---------------------------------------------------------|----------------------|

There is no limit on the number of outstanding Storage Commitment Push Model Requests that can be received and acknowledged before the STORAGE-SCP AE has responded with the corresponding N-EVENT-REPORT Notifications.

**Table F.4.2-26  
OUTSTANDING STORAGE COMMITMENT PUSH MODEL REQUESTS FOR STORAGE-SCP AE**

|                                                                                                           |                  |
|-----------------------------------------------------------------------------------------------------------|------------------|
| Maximum number of outstanding Storage Commitment Requests for which no N-EVENT Notification has been sent | No Maximum Limit |
|-----------------------------------------------------------------------------------------------------------|------------------|

**F.4.2.3.2.4 Implementation Identifying Information**

The implementation information for this Application Entity is:

**Table F.4.2-27  
DICOM IMPLEMENTATION CLASS AND VERSION FOR STORAGE-SCP AE**

|                          |                          |
|--------------------------|--------------------------|
| Implementation Class UID | 1.840.xxxxxxx.yyy.etc... |
|--------------------------|--------------------------|

|                             |            |
|-----------------------------|------------|
| Implementation Version Name | EX_VERS_01 |
|-----------------------------|------------|

Note that the STORAGE-SCP AE specifies a different Implementation Class UID than that used by the other Application Entities. All EXAMPLE-QUERY-RETRIEVE-SERVER AEs use the same Implementation Version Name. This Version Name is updated with each new release of the product software, as the different AE versions are never released independently.

#### **F.4.2.3.3 Association Initiation Policy**

##### **F.4.2.3.3.1 Activity – Send Storage Commitment Notification over new Association**

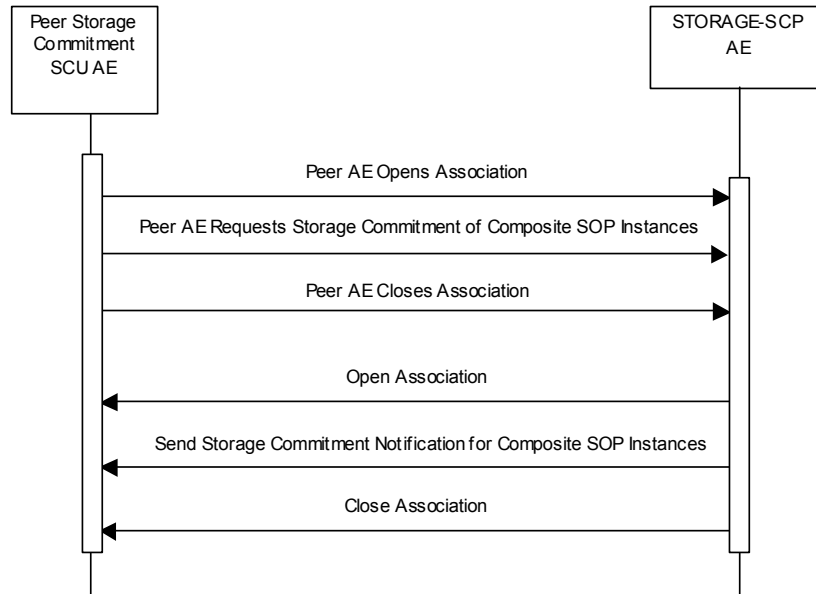
###### **F.4.2.3.3.1.1 Description and Sequencing of Activity**

The STORAGE-SCP AE will initiate a new Association if a Storage Commitment Push Model Notification (N-EVENT-REPORT) cannot be sent back over the original Association used to send the corresponding request. A new Association will always be requested by the STORAGE-SCP AE in such cases even if the peer AE requests another Association after the original has been closed (i.e. A peer AE opens an Association and sends some Storage requests and a Storage Commitment Push Model request. Before the STORAGE-SCP AE can send the Storage Commitment Push Model N-EVEN-REPORT the Association is closed. The peer AE then opens another Association and begins to send Storage requests. In such a case the STORAGE-SCP AE will always initiate a new Association to send the N-EVENT-REPORT even though it could send the N-EVENT-REPORT over the new Association opened by the peer AE).

An Association Request is sent to the peer AE that sent the Storage Commitment Push Model request and upon successful negotiation of the required Presentation Context the outstanding N-EVENT-REPORT is sent. If there are multiple outstanding N-EVENT-REPORTs to be sent to a single peer AE then the STORAGE-SCP AE will attempt to send them all over a single Association rather than requesting a new Association for each one. The Association will be released when all the N-EVENT-REPORTs for the peer AE have been sent. If any type of error occurs during transmission (either a communication failure or indicated by a Status Code returned by the peer AE) over an open Association then the transfer of N-EVENT-REPORTs is halted. A new Association will be opened to retry sending outstanding N-EVENT-REPORTs. The maximum number of times the STORAGE-SCP AE will attempt to resend an N-EVENT-REPORT is configurable, along with the amount of time to wait between attempts to resend.

If the STORAGE-SCP AE sends a Notification request (N-EVENT-REPORT-RQ) over the original Association opened by the peer AE but receives a request to close the Association rather than a response to the Notification (N-EVENT-REPORT-RSP) then this is handled in the same way as if the request to close the Association had been received before trying to send the Notification request. Thus, the STORAGE-SCP AE will then open a new Association to resend the Notification request.

The STORAGE-SCP AE can be configured to always open a new Association before sending a Storage Commitment Push Model Notifications (N-EVENT-REPORT), in which case the sequencing illustrated in Figure 4.2-3 will always be followed.



**Figure F.4.2-3  
SEQUENCING OF ACTIVITY – SEND STORAGE  
COMMITMENT NOTIFICATION OVER NEW ASSOCIATION**

The following sequencing constraints illustrated in Figure F.4.2-3 apply to the STORAGE-SCP AE for handling Storage Commitment Push Model Requests using a new Association:

1. Peer AE opens an Association with the STORAGE-SCP AE.
2. Peer AE requests Storage Commitment of Composite SOP Instance(s) (peer sends N-ACTION-RQ and STORAGE-SCP AE responds with N-ACTION-RSP to indicate that it received the request).
3. Peer AE closes the Association before the STORAGE-SCP AE can successfully send the Storage Commitment Push Model Notification (N-EVENT-REPORT-RQ).
4. STORAGE-SCP AE opens an Association with the peer AE.
5. STORAGE-SCP AE sends Storage Commitment Push Model Notification (N-EVENT-REPORT). More than one can be sent over a single Association if multiple Notifications are outstanding.
6. STORAGE-SCP AE closes the Association with the peer AE.

The Verification Service as an SCU is only supported as a utility function for Service staff. It is used only as a diagnostic tool when the STORAGE-SCP AE is failing to open new Associations to send N-EVENT-REPORTs to peer AEs.

#### **F.4.2.3.3.1.2 Proposed Presentation Contexts**

STORAGE-SCP AE will propose Presentation Contexts as shown in the following table:

**Table F.4.2-28  
PROPOSED PRESENTATION CONTEXTS BY THE STORAGE-SCP AE**

| Presentation Context Table    |                      |                                 |                     |      |           |
|-------------------------------|----------------------|---------------------------------|---------------------|------|-----------|
| Abstract Syntax               |                      | Transfer Syntax                 |                     | Role | Ext. Neg. |
| Name                          | UID                  | Name                            | UID                 |      |           |
| Verification                  | 1.2.840.10008.1.1    | DICOM Implicit VR Little Endian | 1.2.840.10008.1.2   | SCU  | None      |
| Storage Commitment Push Model | 1.2.840.10008.1.20.1 | DICOM Implicit VR Little Endian | 1.2.840.10008.1.2   | SCP  | None      |
| Storage Commitment Push Model | 1.2.840.10008.1.20.1 | DICOM Explicit VR Little Endian | 1.2.840.10008.1.2.1 | SCP  | None      |

#### **F.4.2.3.3.1.3 SOP Specific Conformance for Storage SOP Classes**

The associated Activity with the Storage Commitment Push Model service is the communication by the STORAGE-SCP AE to peer AEs that it has committed to permanently store Composite SOP Instances that have been sent to it. It thus allows peer AEs to determine whether the EXAMPLE-QUERY-RETRIEVE-SERVER has taken responsibility for the archiving of specific SOP Instances so that they can be flushed from the peer AE system.

The STORAGE-SCP AE will initiate a new Association to a peer AE that sent a Storage Commitment Push Model request if the original Association over which this was sent is no longer open. For a detailed explanation of the SOP specific Behavior of the STORAGE-SCP AE in this case please refer to 4.2.4.4.1.3.3, Storage Commitment Push Model as an SCP.

#### **F.4.2.3.3.1.4 SOP Specific Conformance for Verification SOP Class**

Standard conformance is provided to the DICOM Verification Service Class as an SCU. The Verification Service as an SCU is actually only supported as a diagnostic service tool for network communication issues. It can be used to test whether Associations can actually be opened with a peer AE that is issuing Storage Commitment Push Model requests (i.e. to test whether the indicated TCP/IP port and AE Title for sending N-EVENT-REPORT Requests to the peer AE are truly functional).

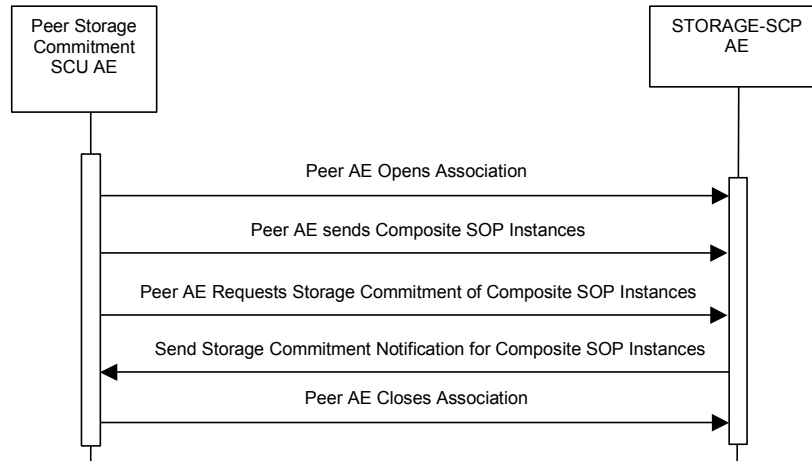
#### **F.4.2.3.4 Association Acceptance Policy**

##### **F.4.2.3.4.1 Activity – Receive Images and Storage Commitment Requests**

###### **F.4.2.3.4.1.1 Description and Sequencing of Activity**

The STORAGE-SCP AE accepts Associations only if they have valid Presentation Contexts. If none of the requested Presentation Contexts are accepted then the Association Request itself is rejected. It can be configured to only accept Associations with certain hosts (using TCP/IP address) and/or Application Entity Titles.

The default behavior of the STORAGE-SCP AE is to always attempt to send a Storage Commitment Push Model Notification (N-EVENT-REPORT) over the same Association opened by the peer AE to send the request (N-ACTION). If the STORAGE-SCP AE receives a request to close the Association either before sending the Notification or before receiving the corresponding N-EVENT-REPORT-RSP then it will open a new Association to send the Notification. Refer to section F.4.2.3.4.1.5 for the details.



**Figure F.4.2-4**  
**SEQUENCING OF ACTIVITY – RECEIVE IMAGES AND STORAGE COMMITMENT REQUESTS**

The following sequencing constraints illustrated in Figure F.4.2-4 apply to the STORAGE-SCP AE for handling Storage Commitment Push Model Requests over the original Association:

1. Peer AE opens an Association with the STORAGE-SCP AE.
2. Peer AE sends zero or more Composite SOP Instances.
3. Peer AE requests Storage Commitment of Composite SOP Instance(s) (peer sends N-ACTION-RQ and STORAGE-SCP AE responds with N-ACTION-RSP to indicate that it received the request).
4. STORAGE-SCP AE sends Storage Commitment Push Model Notification request (N-EVENT-REPORT-RQ) and successfully receives Notification response (N-EVENT-REPORT-RSP) from peer AE.
5. Peer AE closes the Association.

If the STORAGE-SCP AE receives a request to close the Association from the peer AE before sending the Notification request (N-EVENT-REPORT-RQ) or when expecting to receive a Notification response (N-EVENT-REPORT-RSP) then it will open a new Association to send (or resend) the Notification. Refer to 0 for the details. The STORAGE-SCP AE has a configurable timeout value for the maximum amount of time that it will wait on an open Association for a new request from a peer AE. A peer AE can reset this timer by sending a Verification request (C-ECHO-RQ). This can act as a useful mechanism for a peer AE to maintain an active Association if the length of time between sending Storage or Storage Commitment requests can be long (such as when using a single Association to send images as they are acquired during an ultrasound exam).

The STORAGE-SCP AE may reject Association attempts as shown in the Table below. The Result, Source and Reason/Diag columns represent the values returned in the corresponding fields of an ASSOCIATE-RJ PDU (see PS 3.8, Section 9.3.4). The following abbreviations are used in the Source column:

- a. 1 – DICOM UL service-user
- b. 2 – DICOM UL service-provider (ASCE related function)

c. 3 – DICOM UL service-provider (Presentation related function)

**Table F.4.2-29  
ASSOCIATION REJECTION REASONS**

| Result                 | Source | Reason/Diag                                | Explanation                                                                                                                                                                                                                                                                                                                                                          |
|------------------------|--------|--------------------------------------------|----------------------------------------------------------------------------------------------------------------------------------------------------------------------------------------------------------------------------------------------------------------------------------------------------------------------------------------------------------------------|
| 2 – rejected-transient | c      | 2 – local-limit-exceeded                   | The (configurable) maximum number of simultaneous Associations has been reached. An Association request with the same parameters may succeed at a later time.                                                                                                                                                                                                        |
| 2 – rejected-transient | c      | 1 – temporary-congestion                   | No Associations can be accepted at this time due to the real-time requirements of higher priority activities (e.g. during image acquisition no Associations will be accepted) or because insufficient resources are available (e.g. memory, processes, threads). An Association request with the same parameters may succeed at a later time.                        |
| 1 – rejected-permanent | a      | 2 – application-context-name-not-supported | The Association request contained an unsupported Application Context Name. An association request with the same parameters will not succeed at a later time.                                                                                                                                                                                                         |
| 1 – rejected-permanent | a      | 7 – called-AE-title-not-recognized         | The Association request contained an unrecognized Called AE Title. An Association request with the same parameters will not succeed at a later time unless configuration changes are made. This rejection reason normally occurs when the Association initiator is incorrectly configured and attempts to address the Association acceptor using the wrong AE Title. |
| 1 – rejected-permanent | a      | 3 – calling-AE-title-not-recognized        | The Association request contained an unrecognized Calling AE Title. An Association request with the same parameters will not succeed at a later time unless configuration changes are made. This rejection reason normally occurs when the Association acceptor has not been configured to recognize the AE Title of the Association initiator.                      |
| 1 – rejected-permanent | b      | 1 – no-reason-given                        | The Association request could not be parsed. An Association request with the same format will not succeed at a later time.                                                                                                                                                                                                                                           |

**F.4.2.3.4.1.2 Accepted Presentation Contexts**

The default Behavior of the STORAGE-SCP AE supports the Implicit VR Little Endian and Explicit VR Little Endian Transfer Syntaxes for all Associations. In addition, explicit JPEG (baseline lossy) compression syntax is supported for the following SOP Classes: US Image, US Multi-frame Image, US Image (retired), US Multi-frame Image (retired), VL Image, VL Multi-frame and Secondary Capture Image Storage.

The STORAGE-SCP AE can be configured to accept a subset of these Transfer Syntaxes, with the inclusion of Implicit VR Little Endian being mandatory.

If multiple Transfer Syntaxes are proposed per Presentation Context then only the most preferable Transfer Syntax is accepted. The order of Transfer Syntax preference for the STORAGE-SCP AE is configurable. The default preference order if multiple Transfer Syntaxes are proposed in a single Presentation Context is: JPEG Baseline1, Little Endian Explicit, Little Endian Implicit (if all these are proposed for a single Presentation Context). This means that if the Implicit VR Little Endian and Explicit VR Little Endian Transfer Syntaxes are proposed in a single Presentation Context then the accepted Transfer Syntax will be Explicit VR Little Endian. This order of preference is configurable.

Any of the Presentation Contexts shown in the following table are acceptable to the STORAGE-SCP AE for receiving images.



**Table F.4.2-30**  
**ACCEPTED PRESENTATION CONTEXTS BY STORAGE-SCP AE**

| Presentation Context Table       |                             |                                                |                        |      |           |
|----------------------------------|-----------------------------|------------------------------------------------|------------------------|------|-----------|
| Abstract Syntax                  |                             | Transfer Syntax                                |                        | Role | Ext. Neg. |
| Name                             | UID                         | Name                                           | UID                    |      |           |
| Verification                     | 1.2.840.10008.1.1           | DICOM Implicit VR Little Endian                | 1.2.840.10008.1.2      | SCP  | None      |
| Storage Commitment Push Model    | 1.2.840.10008.1.20.1        | DICOM Implicit VR Little Endian                | 1.2.840.10008.1.2      | SCP  | None      |
| Storage Commitment Push Model    | 1.2.840.10008.1.20.1        | DICOM Explicit VR Little Endian                | 1.2.840.10008.1.2.1    | SCP  | None      |
| US Image Storage (Retired)       | 1.2.840.10008.5.1.4.1.1.6   | DICOM Implicit VR Little Endian                | 1.2.840.10008.1.2      | SCP  | None      |
| US Image Storage (Retired)       | 1.2.840.10008.5.1.4.1.1.6   | DICOM Explicit VR Little Endian                | 1.2.840.10008.1.2.1    | SCP  | None      |
| US Image Storage (Retired)       | 1.2.840.10008.5.1.4.1.1.6   | DICOM Explicit JPEG baseline lossy compression | 1.2.840.10008.1.2.4.50 | SCP  | None      |
| US Image Storage                 | 1.2.840.10008.5.1.4.1.1.6.1 | DICOM Implicit VR Little Endian (uncompressed) | 1.2.840.10008.1.2      | SCP  | None      |
| US Image Storage                 | 1.2.840.10008.5.1.4.1.1.6.1 | DICOM Explicit VR Little Endian (uncompressed) | 1.2.840.10008.1.2.1    | SCP  | None      |
| US Image Storage                 | 1.2.840.10008.5.1.4.1.1.6.1 | DICOM Explicit JPEG baseline lossy compression | 1.2.840.10008.1.2.4.50 | SCP  | None      |
| US Multi-frame Storage (Retired) | 1.2.840.10008.5.1.4.1.1.3   | DICOM Implicit VR Little Endian                | 1.2.840.10008.1.2      | SCP  | None      |
| US Multi-frame Storage (Retired) | 1.2.840.10008.5.1.4.1.1.3   | DICOM Explicit VR Little Endian                | 1.2.840.10008.1.2.1    | SCP  | None      |
| US Multi-frame Storage (Retired) | 1.2.840.10008.5.1.4.1.1.3   | DICOM Explicit JPEG baseline lossy compression | 1.2.840.10008.1.2.4.50 | SCP  | None      |
| US Multi-frame Storage           | 1.2.840.10008.5.1.4.1.1.3.1 | DICOM Implicit VR Little Endian (uncompressed) | 1.2.840.10008.1.2      | SCP  | None      |
| US Multi-frame Storage           | 1.2.840.10008.5.1.4.1.1.3.1 | DICOM Explicit VR Little Endian (uncompressed) | 1.2.840.10008.1.2.1    | SCP  | None      |

| Presentation Context Table         |                             |                                                |                        |     |      |
|------------------------------------|-----------------------------|------------------------------------------------|------------------------|-----|------|
| Abstract Syntax                    |                             | Transfer Syntax                                |                        |     |      |
| US Multi-frame Storage             | 1.2.840.10008.5.1.4.1.1.3.1 | DICOM Explicit JPEG baseline lossy compression | 1.2.840.10008.1.2.4.50 | SCP | None |
| Computer Radiography Image Storage | 1.2.840.10008.5.1.4.1.1.1   | DICOM Implicit VR Little Endian                | 1.2.840.10008.1.2      | SCP | None |
| Computer Radiography Image Storage | 1.2.840.10008.5.1.4.1.1.1   | DICOM Explicit VR Little Endian                | 1.2.840.10008.1.2.1    | SCP | None |
| CT Image Storage                   | 1.2.840.10008.5.1.4.1.1.2   | DICOM Implicit VR Little Endian                | 1.2.840.10008.1.2      | SCP | None |
| CT Image Storage                   | 1.2.840.10008.5.1.4.1.1.2   | DICOM Explicit VR Little Endian                | 1.2.840.10008.1.2.1    | SCP | None |
| MR Image Storage                   | 1.2.840.10008.5.1.4.1.1.4   | DICOM Implicit VR Little Endian                | 1.2.840.10008.1.2      | SCP | None |
| MR Image Storage                   | 1.2.840.10008.5.1.4.1.1.4   | DICOM Explicit VR Little Endian                | 1.2.840.10008.1.2.1    | SCP | None |
| NM Image Storage (Retired)         | 1.2.840.10008.5.1.4.1.1.5   | DICOM Implicit VR Little Endian                | 1.2.840.10008.1.2      | SCP | None |
| Secondary Capture Image Storage    | 1.2.840.10008.5.1.4.1.1.7   | DICOM Implicit VR Little Endian                | 1.2.840.10008.1.2      | SCP | None |
| Secondary Capture Image Storage    | 1.2.840.10008.5.1.4.1.1.7   | DICOM Explicit VR Little Endian                | 1.2.840.10008.1.2.1    | SCP | None |
| Secondary Capture Image Storage    | 1.2.840.10008.5.1.4.1.1.7   | DICOM Explicit JPEG lossy compression          | 1.2.840.10008.1.2.4.50 | SCP | None |

**F.4.2.3.4.1.3 SOP Specific Conformance for Verification SOP Class**

The STORAGE-SCP AE provides standard conformance to the Verification SOP Class as an SCP.

**F.4.2.3.4.1.4 SOP Specific Conformance for Storage SOP Classes**

The associated Activity with the Storage service is the storage of medical image data received over the network on a designated hard disk. The STORAGE-SCP AE will return a failure status if it is unable to store the images on to the hard disk.

The STORAGE-SCP AE does not have any dependencies on the number of Associations used to send images to it. Images belonging to more than one Study or Series can be sent over a single or multiple Associations. Images belonging to a single Study or Series can also be sent over different Associations. There is no limit on either the number of SOP Instances or the maximum amount of total SOP Instance data that can be transferred over a single Association.

The STORAGE-SCP AE is configured to retain the original DICOM data in DICOM Part 10 compliant file format. The STORAGE-SCP AE is Level 2 (Full) conformant as a Storage SCP. In addition, all Private and SOP Class Extended Elements are maintained in the DICOM format files. In addition to saving all

Elements in files, a subset of the Elements are stored in the EXAMPLE-QUERY-RETRIEVE-SERVER database to support query and retrieval requests and also allow updating of Patient, Study, and Series information by user input, or demographic and Study related messages. Refer to the Annex for the list of Elements that are checked and/or processed upon receiving a Composite SOP Instance.

The Behavior for handling duplicate SOP Instances is configurable. The default Behavior is to assign a new SOP Instance UID to a received SOP Instance if it conflicts with an existing SOP Instance UID. An alternative configuration is possible that causes the original object with the conflicting SOP Instance UID to be replaced by the new SOP Instance. This Behavior is most commonly enabled if a Storage SCU re-sends entire Studies or Series if a single failure occurs when sending a group of SOP Instances.

For the purposes of image display the system supports the following photometric interpretations: MONOCHROME1, MONOCHROME2, RGB, PALETTE COLOR, YBR FULL 422, and YBR FULL.

It is expected that optimal Window Center and Width values are specified in the DICOM Image Objects if they have greater than 8 bits of image data stored per sample. If optimal Window Center and Width values are not provided, then the EXAMPLE-QUERY-RETRIEVE-SERVER is capable of estimating values using histogram analysis.

For multi-frame image SOP Instances sent using JPEG compression Transfer Syntax, sending a fully specified offset table increases performance, because the entire file does not have to be parsed to find the individual frame offsets. However, the inclusion of an offset table is not required for archiving or viewing of such SOP Instances.

Display of information conveyed using the DICOM Curve Module is not supported. Graphic overlay data sent either embedded in the unused image pixel data bits or in the separate Overlay Data Element is supported for display. Region of Interest overlays are not yet supported.

If an image SOP Instance specifies an aspect ratio that is not one-to-one then the image data will be automatically resized when displayed on the system monitor so that they are always displayed in a one-to-one aspect ratio.

The average throughput performance has been determined to be between 2 and 6 Mega Bytes per second on a 100 Megabit Ethernet network. Actual performance will depend greatly on the performance of the C-STORE SCU, the number of simultaneous active Associations, and the underlying network performance.

**Table F.4.2-31  
STORAGE-SCP AE C-STORE RESPONSE STATUS RETURN REASONS**

| <b>Service Status</b> | <b>Further Meaning</b> | <b>Error Code</b> | <b>Reason</b>                                                                                                                                         |
|-----------------------|------------------------|-------------------|-------------------------------------------------------------------------------------------------------------------------------------------------------|
| Success               | Success                | 0000              | The Composite SOP Instance was successfully received, verified, and stored in the system database.                                                    |
| Refused               | Out of Resources       | A700              | Indicates that there was not enough disk space to store the image.<br>Error message is output to the Service Log. The SOP Instance will not be saved. |

|         |                                   |      |                                                                                                                                                                                                                                                                                                                                                                                                                                                                                                                                                                                                                                                                                     |
|---------|-----------------------------------|------|-------------------------------------------------------------------------------------------------------------------------------------------------------------------------------------------------------------------------------------------------------------------------------------------------------------------------------------------------------------------------------------------------------------------------------------------------------------------------------------------------------------------------------------------------------------------------------------------------------------------------------------------------------------------------------------|
| Error   | Data Set does not match SOP Class | A900 | Indicates that the Data Set does not encode a valid instance of the SOP Class specified. This status is returned if the DICOM Object stream can be successfully parsed but does not contain values for one or more mandatory Elements of the SOP Class. The STORAGE-SCP AE does not perform a comprehensive check, as it only checks a subset of required Elements. In addition, if the SOP Class is for a type of image but the SOP Instance does not contain values necessary for its display then this status is returned.<br><br>Error message is output to the Service Log. The system can be configured to temporarily save such Data Sets in order to aid problem diagnosis. |
|         | Cannot understand                 | C000 | Indicates that the STORAGE-SCP AE cannot parse the Data Set into Elements.<br><br>Error message is output to the Service Log. The system can be configured to temporarily save such Data Sets in order to aid problem diagnosis.                                                                                                                                                                                                                                                                                                                                                                                                                                                    |
| Warning | Coercion of Data Elements         | B000 | Indicates that one or more Element values were coerced. Refer to the Attributes defined in Annex for a list of those that can be coerced. Note that return of this status is disabled by default, as some SCUs treat it as an Error code rather than a Warning.                                                                                                                                                                                                                                                                                                                                                                                                                     |

NOTE: If a failure condition does occur when handling an Association then all images previously received successfully over the Association are maintained in the EXAMPLE-QUERY-RETRIEVE-SERVER database. No previously successfully received images are discarded. Even if an image is successfully received but an error occurs transmitting the C-STORE Response then this final image is maintained rather than discarded. If the loss of an Association is detected then the Association is closed.

The Behavior of STORAGE-SCP AE during communication failure is summarized in the following table:

**Table F.4.2-32**  
**STORAGE-SCP AE STORAGE SERVICE COMMUNICATION FAILURE REASONS**

| Exception                                                                                                                                                                                 | Reason                                                                                                                                                                                                                                                                                                                                   |
|-------------------------------------------------------------------------------------------------------------------------------------------------------------------------------------------|------------------------------------------------------------------------------------------------------------------------------------------------------------------------------------------------------------------------------------------------------------------------------------------------------------------------------------------|
| Timeout expiry for an expected DICOM Message Request (DIMSE level timeout). I.e. The STORAGE-SCP AE is waiting for the next C-STORE Request on an open Association but the timer expires. | The Association is aborted by issuing a DICOM A-ABORT. Error message is output to the Service Log. If some Composite SOP Instances have already been successfully received then they are maintained in the database. They are not automatically discarded because of a later failure.                                                    |
| Timeout expiry for an expected DICOM PDU or TCP/IP packet (Low-level timeout). I.e. The STORAGE-SCP AE is waiting for the next C-STORE Data Set PDU but the timer expires.                | The Association is aborted by issuing a DICOM A-ABORT. Error message is output to the Service Log. If a C-STORE Data Set has not been fully received then the data already received is discarded. If some Composite SOP Instances have already been successfully received over the Association then they are maintained in the database. |
| Association aborted by the SCU or the network layers indicate communication loss (i.e. low-level TCP/IP socket closure)                                                                   | Error message is output to the Service Log. If some Composite SOP Instances have already been successfully received then they are maintained in the database. They are not automatically discarded because of a later failure.                                                                                                           |

**F.4.2.3.4.1.5 SOP Specific Conformance for Storage Commitment SOP Class**

The associated Activity with the Storage Commitment Push Model service is the communication by the STORAGE-SCP AE to peer AEs that it has committed to permanently store Composite SOP Instances that have been sent to it. It thus allows peer AEs to determine whether the EXAMPLE-QUERY-RETRIEVE-SERVER has taken responsibility for the archiving of specific SOP Instances so that they can be flushed from the peer AE system.

The STORAGE-SCP AE takes the list of Composite SOP Instance UIDs specified in a Storage Commitment Push Model N-ACTION Request and checks if they are present in the EXAMPLE-QUERY-RETRIEVE-SERVER database. As long as the Composite SOP Instance UIDs are present in the database, the STORAGE-SCP AE will consider those Composite SOP Instance UIDs to be successfully archived. The STORAGE-SCP AE does not require the Composite SOP Instances to actually be successfully written to archive media in order to commit to responsibility for maintaining these SOP Instances.

Once the STORAGE-SCP AE has checked for the existence of the specified Composite SOP Instances, it will then attempt to send the Notification request (N-EVENT-REPORT-RQ). The default behavior is to attempt to send this Notification over the same Association that was used by the peer AE to send the original N-ACTION Request. If the Association has already been released or Message transfer fails for some reason then the STORAGE-SCP AE will attempt to send the N-EVENT-REPORT-RQ over a new Association. The STORAGE-SCP AE will request a new Association with the peer AE that made the original N-ACTION Request. The STORAGE-SCP AE can be configured to always open a new Association in order to send the Notification request.

The STORAGE-SCP AE will not cache Storage Commitment Push Model N-ACTION Requests that specify Composite SOP Instances that have not yet been transferred to the EXAMPLE-QUERY-RETRIEVE-SERVER. If a peer AE sends a Storage Commitment Push Model N-ACTION Request before the specified Composite SOP Instances are later sent over the same Association, the STORAGE-SCP AE will not commit to responsibility for such SOP Instances.

The STORAGE-SCP AE does not support the optional Storage Media File-Set ID & UID attributes in the N-ACTION.

The EXAMPLE-QUERY-RETRIEVE-SERVER never automatically deletes Composite SOP Instances from the archive. The absolute persistence of SOP Instances and the maximum archiving capacity for such SOP Instances is dependent on the archiving media and capacity used by the EXAMPLE-QUERY-RETRIEVE-SERVER and is dependent on the actual specifications of the purchased system. It is necessary to check the actual system specifications to determine these characteristics.

The STORAGE-SCP AE will support Storage Commitment Push Model requests for SOP Instances of any of the Storage SOP Classes that are also supported by the STORAGE-SCP AE:

**Table F.4.2-33  
SUPPORTED REFERENCED SOP CLASSES IN STORAGE  
COMMITMENT PUSH MODEL N-ACTION REQUESTS**

| <b>Supported Referenced SOP Classes</b> |
|-----------------------------------------|
| US Image Storage (Retired)              |
| US Image Storage                        |
| US Multi-frame Storage (Retired)        |
| US Multi-frame Storage                  |
| Computed Radiography Image Storage      |
| CT Image Storage                        |
| MR Image Storage                        |

|                                 |
|---------------------------------|
| Secondary Capture Image Storage |
|---------------------------------|

The STORAGE-SCP AE will return the following Status Code values in N-ACTION Responses:

**Table F.4.2-34**  
**STORAGE-SCP AE STORAGE COMMITMENT PUSH**  
**MODEL N-ACTION RESPONSE STATUS RETURN BEHAVIOR**

| Service Status | Further Meaning         | Error Code | Behavior                                                                                                                                                                    |
|----------------|-------------------------|------------|-----------------------------------------------------------------------------------------------------------------------------------------------------------------------------|
| Success        | Success                 | 0000       | The SCP has successfully received the Storage Commitment Push Model N-ACTION Request and can process the commitment request for the indicated SOP Instances.                |
| Error          | Processing Failure      | 0110       | Indicates that the Storage Commitment Push Model N-ACTION Request cannot be parsed or fully processed due to a database or system failure.                                  |
| Error          | Missing Attribute       | 0120       | Indicates that the Storage Commitment Push Model N-ACTION Request cannot be processed because a required attribute is missing from the N-ACTION Request Data Set.           |
| Error          | Missing Attribute Value | 0121       | Indicates that the Storage Commitment Push Model N-ACTION Request cannot be processed because a Type 1 attribute in the N-ACTION Request Data Set does not specify a value. |

The STORAGE-SCP AE will exhibit the following Behavior according to the Status Code value returned in an N-EVENT-REPORT Response from a destination Storage Commitment Push Model SCU:

**Table F.4.2-35**  
**STORAGE-SCP AE N-EVENT-REPORT RESPONSE STATUS HANDLING BEHAVIOR**

| Service Status | Further Meaning      | Error Code             | Behavior                                                                                                                                                                                             |
|----------------|----------------------|------------------------|------------------------------------------------------------------------------------------------------------------------------------------------------------------------------------------------------|
| Success        | Success              | 0000                   | The SCU has successfully received the Storage Commitment Push Model N-EVENT-REPORT Request. Success indication message is output to the Service Logs. No message is posted to the User Interface.    |
| Warning        | Attribute List Error | 0107                   | Transmission of Storage Commitment Push Model N-EVENT-REPORT Request is considered successful. Warning indication message is output to the Service Logs. No message is posted to the User Interface. |
| *              | *                    | Any other status code. | This is treated as a permanent Failure. Error indication message is output to the Service Logs. No message is posted to the User Interface.                                                          |

All Status Codes indicating an error or refusal are treated as a permanent failure. The STORAGE-SCP AE can be configured to automatically reattempt the sending of Storage Commitment Push Model N-EVENT-REPORT Requests if an error Status Code is returned or a communication failure occurs. The maximum number of times to attempt sending as well as the time to wait between attempts is configurable.

**Table F.4.2-36  
STORAGE-SCP AE STORAGE COMMITMENT PUSH MODEL  
COMMUNICATION FAILURE BEHAVIOR**

| Exception                                                                                                                                                                                                 | Behavior                                                                                                                                                                                                                                                                                                                                                                                                                                                                                                                                                       |
|-----------------------------------------------------------------------------------------------------------------------------------------------------------------------------------------------------------|----------------------------------------------------------------------------------------------------------------------------------------------------------------------------------------------------------------------------------------------------------------------------------------------------------------------------------------------------------------------------------------------------------------------------------------------------------------------------------------------------------------------------------------------------------------|
| <p>Timeout expiry for an expected DICOM Message Request (DIMSE level timeout). I.e. The STORAGE-SCP AE is waiting for the next N-ACTION Request on an open Association but the timer expires.</p>         | <p>The Association is aborted by issuing a DICOM A-ABORT.</p> <p>If some Composite SOP Instances have been successfully received over the same Association via the Storage Service then they are maintained in the database. They are not automatically discarded because of a later Storage Commitment messaging failure.</p> <p>Any previously received Storage Commitment Push Model N-ACTION Requests will still be fully processed.</p> <p>Error indication message is output to the Service Logs.</p> <p>No message is posted to the User Interface.</p> |
| <p>Timeout expiry for an expected DICOM Message Response (DIMSE level timeout). I.e. The STORAGE-SCP AE is waiting for the next N-EVENT-REPORT Response on an open Association but the timer expires.</p> | <p>The Association is aborted by issuing a DICOM A-ABORT.</p> <p>If some Composite SOP Instances have been successfully received over the same Association via the Storage Service then they are maintained in the database. They are not automatically discarded because of a later Storage Commitment messaging failure.</p> <p>Any previously received Storage Commitment Push Model N-ACTION Requests will still be fully processed.</p> <p>Error indication message is output to the Service Logs.</p> <p>No message is posted to the User Interface.</p> |
| <p>Timeout expiry for an expected DICOM PDU or TCP/IP packet (Low-level timeout).</p>                                                                                                                     | <p>The Association is aborted by issuing a DICOM A-ABORT.</p> <p>If some Composite SOP Instances have been successfully received over the same Association via the Storage Service then they are maintained in the database. They are not automatically discarded because of a later Storage Commitment messaging failure.</p> <p>Any previously received Storage Commitment Push Model N-ACTION Requests will still be fully processed.</p> <p>Error indication message is output to the Service Logs.</p> <p>No message is posted to the User Interface.</p> |
| <p>Association A-ABORTed by the SCU or the network layers indicate communication loss (i.e. low-level TCP/IP socket closure)</p>                                                                          | <p>The TCP/IP socket is closed.</p> <p>If some Composite SOP Instances have been successfully received over the same Association via the Storage Service then they are maintained in the database. They are not automatically discarded because of a later Storage Commitment messaging failure.</p> <p>Any previously received Storage Commitment Push Model N-ACTION Requests will still be fully processed.</p> <p>Error indication message is output to the Service Logs.</p> <p>No message is posted to the User Interface.</p>                           |

### F.4.3 NETWORK INTERFACES

#### F.4.3.1 Physical Network Interface

The EXAMPLE-QUERY-RETRIEVE-SERVER supports a single network interface. One of the following physical network interfaces will be available depending on installed hardware options:

**Table F.4.3-1  
SUPPORTED PHYSICAL NETWORK INTERFACES**

|                   |
|-------------------|
| Ethernet 100baseT |
| Ethernet 10baseT  |

#### F.4.3.2 Additional Protocols

EXAMPLE-QUERY-RETRIEVE-SERVER conforms to the System Management Profiles listed in Table F.4.3-2. All requested transactions for the listed profiles and actors are supported. It does not support any optional transactions.

**Table F.4.3-2  
SUPPORTED SYSTEM MANAGEMENT PROFILES**

| Profile Name               | Actor       | Protocols Used | Optional Transactions | Security Support |
|----------------------------|-------------|----------------|-----------------------|------------------|
| Network Address Management | DHCP Client | DHCP           | N/A                   |                  |
|                            | DNS Client  | DNS            | N/A                   |                  |

#### F.4.3.2.1 DHCP

DHCP can be used to obtain TCP/IP network configuration information. The network parameters obtainable via DHCP are shown in Table F.4.3-3. The Default Value column of the table shows the default used if the DHCP server does not provide a value. Values for network parameters set in the Service/Installation tool take precedence over values obtained from the DHCP server. Support for DHCP can be configured via the Service/Installation Tool. The Service/Installation tool can be used to configure the machine name. If DHCP is not in use, TCP/IP network configuration information can be manually configured via the Service/Installation Tool.

**Table F.4.3-3  
SUPPORTED DHCP PARAMETERS**

| DHCP Parameter      | Default Value                                |
|---------------------|----------------------------------------------|
| IP Address          | None                                         |
| Hostname            | Requested machine name                       |
| List of NTP servers | Empty list                                   |
| List of DNS servers | Empty list                                   |
| Routers             | Empty list                                   |
| Static routes       | None                                         |
| Domain name         | None                                         |
| Subnet mask         | Derived from IP Address (see service manual) |
| Broadcast address   | Derived from IP Address (see service manual) |
| Default router      | None                                         |



|                    |                                    |
|--------------------|------------------------------------|
| Time offset        | Site configurable (from Time zone) |
| MTU                | Network Hardware Dependent         |
| Auto-IP permission | No permission                      |

If the DHCP server refuses to renew a lease on the assigned IP address all active DICOM Associations will be aborted.

#### F.4.3.2.2 DNS

DNS can be used for address resolution. If DHCP is not in use or the DHCP server does not return any DNS server addresses, the identity of a DNS server can be configured via the Service/Installation Tool. If a DNS server is not in use, local mapping between hostname and IP address can be manually configured via the Service/Installation Tool.

#### F.4.3.3 IPv4 and IPv6 Support

This product supports both IPv4 and IPv6. It does not utilize any of the optional configuration identification or security features of IPv6.

### F.4.4 CONFIGURATION

#### F.4.4.1 AE Title/Presentation Address Mapping

##### F.4.4.1.1 Local AE Titles

The mapping from AE Title to TCP/IP addresses and ports is configurable and set at the time of installation by Installation Personnel.

**Table F.4.4-1  
DEFAULT APPLICATION ENTITY CHARACTERISTICS**

| Application Entity | Role | Default AE Title | Default TCP/IP Port |
|--------------------|------|------------------|---------------------|
| STORAGE-SCU        | SCU  | EX_STORE_SCU     | None                |
| STORAGE-SCP        | SCP  | EX_STORE_SCP     | 4000                |
| QUERY-RETRIEVE-SCP | SCP  | EX_QUERY_SCP     | 5000                |

The STORAGE-SCU and QUERY-RETRIEVE-SCP Application Entities can be configured to have the same AE Title. The STORAGE-SCP Application Entity must not have the same AE Title as the other two.

##### F.4.4.1.2 Remote AE Title/Presentation Address Mapping

The mapping of external AE Titles to TCP/IP addresses and ports is configurable and set at the time of installation by Installation Personnel. This mapping is necessary for resolving the IP address and port of C-MOVE Destination Application Entities and must be correctly configured for the QUERY-RETRIEVE-SCP AE to correctly function as a C-MOVE SCP.

#### F.4.4.2 Parameters

**Table F.4.4-2  
CONFIGURATION PARAMETERS**

| Parameter                                                                      | Configurable | Default Value |
|--------------------------------------------------------------------------------|--------------|---------------|
| <b>General Parameters</b>                                                      |              |               |
| Maximum PDU size I can receive                                                 | Yes          | 128kbytes     |
| Maximum PDU size I can send                                                    | Yes          | 128kbytes     |
| Time-out waiting for response to TCP/IP connect() request. (Low-level timeout) | Yes          | 10 s          |

|                                                                                                                                                                     |                                                                 |                                                                                                  |
|---------------------------------------------------------------------------------------------------------------------------------------------------------------------|-----------------------------------------------------------------|--------------------------------------------------------------------------------------------------|
| Time-out waiting for A-ASSOCIATE RQ PDU on open TCP/IP connection. (ARTIM timeout)                                                                                  | Yes                                                             | 30 s                                                                                             |
| Time-out waiting for acceptance or rejection response to an Association Open Request. (Application Level timeout)                                                   | Yes                                                             | 30s                                                                                              |
| Time-out waiting for acceptance of a TCP/IP message over the network. (Low-level timeout)                                                                           | Yes                                                             | 30 s                                                                                             |
| Time-out for waiting for data between TCP/IP packets. (Low-level timeout)                                                                                           | Yes                                                             | 30 s                                                                                             |
| The Windows NT TCP/IP socket buffer size is set to 1,342,177 bytes in order to improve image data throughput performance.                                           | No                                                              | 1,342,177 bytes                                                                                  |
| <b>STORAGE-SCU AE Parameters</b>                                                                                                                                    |                                                                 |                                                                                                  |
| Maximum number of simultaneous Associations.                                                                                                                        | Yes                                                             | 10                                                                                               |
| STORAGE-SCU AE time-out waiting for a Response to a C-STORE-RQ. (DIMSE timeout)                                                                                     | Yes                                                             | 5 minutes                                                                                        |
| STORAGE-SCU AE number of times a failed send job to a C-MOVE Destination is automatically retried.                                                                  | No                                                              | 0                                                                                                |
| <b>STORAGE-SCP AE Parameters</b>                                                                                                                                    |                                                                 |                                                                                                  |
| Maximum PDU Size                                                                                                                                                    | Yes                                                             | 16384                                                                                            |
| Maximum number of simultaneous Associations<br>(Can be configured to be a maximum total number or a maximum per external SCU AE)                                    | Yes                                                             | 10                                                                                               |
| STORAGE-SCP AE time-out waiting on an open Association for the next Request message (C-STORE-RQ, Association Close Request. etc.) (DIMSE timeout)                   | Yes                                                             | 15 minutes                                                                                       |
| STORAGE-SCP AE maximum number of simultaneous Associations                                                                                                          | Yes<br>(NOTE: Can be configured with a maximum per external AE) | 10                                                                                               |
| Permanent archival of SOP Instances sent by a peer AE to the STORAGE-SCP AE in response to a retrieval request from QUERY-RETRIEVE AE.                              | Yes                                                             | FALSE<br>(Such received SOP Instances are not archived.)                                         |
| Permanent archival of SOP Instances sent unsolicited by a peer AE to the STORAGE-SCP AE. I.e. Not in response to a retrieval request from QUERY-RETRIEVE AE.        | Yes                                                             | TRUE<br>(Such received SOP Instances are archived.)                                              |
| Always open a new Association to send a Storage Commitment Push Model Notification request (N-EVENT-REPORT-RQ).                                                     | Yes                                                             | FALSE<br>(Default is to try and send Notifications over original Association opened by peer AE). |
| Maximum number of times to attempt sending a Storage Commitment Push Model N-EVENT-REPORT Request when an error status is returned or communication failure occurs. | Yes                                                             | 5                                                                                                |
| Time to wait between attempts to send a Storage                                                                                                                     | Yes                                                             | 5 minutes                                                                                        |

|                                                                                                                                                            |                                                                 |           |
|------------------------------------------------------------------------------------------------------------------------------------------------------------|-----------------------------------------------------------------|-----------|
| Commitment Push Model N-EVENT-REPORT Request when an error status is returned or communication failure occurs.                                             |                                                                 |           |
| <b>QUERY-RETRIEVE-SCP AE Parameters</b>                                                                                                                    |                                                                 |           |
| Maximum PDU Size                                                                                                                                           | Yes                                                             | 16384     |
| Maximum number of simultaneous Associations<br>(Can be configured to be a maximum total number or a maximum per external SCU AE)                           | Yes                                                             | 10        |
| QUERY-RETRIEVE-SCP AE time-out waiting on an open Association for the next message (C-FIND-RQ, C-MOVE-RQ, Association Close Request. etc.) (DIMSE timeout) | Yes                                                             | 3 minutes |
| QUERY-RETRIEVE-SCP AE maximum number of simultaneous Associations                                                                                          | Yes<br>(NOTE: Can be configured with a maximum per external AE) | 10        |

## **F.5 MEDIA INTERCHANGE**

EXAMPLE-QUERY-RETRIEVE-SERVER does not support Media Storage.

## **F.6 SUPPORT OF EXTENDED CHARACTER SETS**

All EXAMPLE-QUERY-RETRIEVE-SERVER DICOM applications support the following:

ISO\_IR 100 (ISO 8859-1:1987 Latin Alphabet No. 1 supplementary set)

As well as supporting this Extended Character Set for DICOM messaging, the Query-Server system database and user interface can support the expected display of this character set.

## **F.7 SECURITY**

### **F.7.1 SECURITY PROFILES**

The EXAMPLE-QUERY-RETRIEVE-SERVER conforms to the bit preserving Digital Signatures Security Profile, if the STORAGE SCP AE receives a SOP Instance in an Explicit Transfer Syntax and the STORAGE SCU AE can export such SOP Instances using an Explicit Transfer Syntax.

### **F.7.2 ASSOCIATION LEVEL SECURITY**

The QUERY-RETRIEVE-SCP AE and the STORAGE-SCP AE can both be configured to check the following DICOM values when determining whether to accept Association Open Requests:

Calling AE Title

Called AE Title

Application Context

Each SCP AE can be configured to accept Association Requests from only a limited list of Calling AE Titles. They SCP AEs can have different lists. Each SCP AE can be configured to check that the Association requestor specifies the correct Called AE Title for the SCP.

In addition the IP address of the requestor can be checked. The SCP AEs can be constrained to only accept Association Requests from a configured list of IP addresses. The SCP AE's can have different lists.

**F.8 ANNEXES**

**F.8.1 IOD CONTENTS**

**F.8.1.1 Storage-SCP AE Element Use**

The following Elements of Composite SOP Instances received by the STORAGE-SCP AE are either stored to the permanent EXAMPLE-QUERY-RETRIEVE-SERVER database or of particular importance in the received images.

SOP Instances conforming to the following Composite Image SOP Classes are fully supported for display on the system workstations.

**Table F.8.1-1  
SUPPORTED COMPOSITE IMAGE SOP CLASSES FOR DISPLAY**

|                                    |
|------------------------------------|
| US Image Storage (Retired)         |
| US Image Storage                   |
| US Multi-frame Storage (Retired)   |
| US Multi-frame Storage             |
| Computed Radiography Image Storage |
| CT Image Storage                   |
| MR Image Storage                   |
| Secondary Capture Image Storage    |

**Table F.8.1-2  
SIGNIFICANT ELEMENTS IN RECEIVED COMPOSITE SOP INSTANCES**

| Module  | Attribute Name | Tag ID      | Type | Significance                                                                                                                                                                                                                                                                                                                                                                                                                                                                                                                            |
|---------|----------------|-------------|------|-----------------------------------------------------------------------------------------------------------------------------------------------------------------------------------------------------------------------------------------------------------------------------------------------------------------------------------------------------------------------------------------------------------------------------------------------------------------------------------------------------------------------------------------|
| Patient | Patient Name   | (0010,0010) | Opt  | <p>STORAGE-SCP AE can be configured to apply a default value if there is no value specified.</p> <p>Value is saved to database as separate first and last names. Only first and last names are entered in the EXAMPLE-QUERY-RETRIEVE-SERVER database. Both first and last names can be a maximum of 64 characters each.</p> <p>Names will be parsed correctly if they are in the format of 'lname^fname' or 'lname, fname'. If space separation is used (i.e. 'lname fname') then the entire name will be treated as the last name.</p> |

|                |                            |             |      |                                                                                                                                                                                                                                                                                                                                                                                        |
|----------------|----------------------------|-------------|------|----------------------------------------------------------------------------------------------------------------------------------------------------------------------------------------------------------------------------------------------------------------------------------------------------------------------------------------------------------------------------------------|
|                | Patient ID                 | (0010,0020) | Opt  | STORAGE-SCP AE can be configured to apply a default value if there is no value specified.<br>Verification on incoming Patient IDs is performed. If an ID already exists but the existing name does not match, then the ID is coerced because different Patient records in the EXAMPLE-QUERY-RETRIEVE-SERVER database cannot have identical Patient IDs.<br>Value is saved to database. |
|                | Patient's Birth Date       | (0010,0030) | Opt  | STORAGE-SCP AE can be configured to apply a default value if there is no value specified.<br>Value is saved to database.                                                                                                                                                                                                                                                               |
|                | Patient's Sex              | (0010,0040) | Opt  | First character must be 'M', 'm', 'F', 'f', 'O', or 'o'. If a different value, or not specified, then will be entered in the database as 'U', unknown. Value is saved to database. 'U' is never exported in DICOM images; instead, the Element value will be left empty for export.                                                                                                    |
| General Study  | Study Instance UID         | (0020,000D) | Mand | Must be provided.<br>Value is saved to database.                                                                                                                                                                                                                                                                                                                                       |
|                | Study Date                 | (0008,0020) | Opt  | STORAGE-SCP AE can be configured to apply a default value if there is no value specified.<br>Value is saved to database.                                                                                                                                                                                                                                                               |
|                | Referring Physician's Name | (0008,0090) | Opt  | Value is saved to database.                                                                                                                                                                                                                                                                                                                                                            |
|                | Accession Number           | (0008,0050) | Opt  | STORAGE-SCP AE can be configured to apply a default value if there is no value specified. Matching used to determine which Accession number to apply is configurable (i.e. HIS/RIS provided Accession Number may be used if the Patient ID, Patient Name, Study Date, and Modality provided in the HIS/RIS and SOP Instance match).<br>Value is saved to database.                     |
|                | Study Description          | (0008,1030) | Opt  | If matched value(s) in the EXAMPLE-QUERY-RETRIEVE-SERVER exam type database, then it will be saved to the database as an exam type.                                                                                                                                                                                                                                                    |
| General Series | Modality                   | (0008,0060) | Opt  | STORAGE-SCP AE can be configured to apply a default value if there is no value specified.<br>Value is saved to database but must be two characters in length.                                                                                                                                                                                                                          |
|                | Series Description         | (0008,103E) | Opt  | If matched value(s) in the EXAMPLE-QUERY-RETRIEVE-SERVER exam type database then it will be saved to the database as an exam type.                                                                                                                                                                                                                                                     |
|                | Operator's Name            | (0008,1070) | Opt  | Value is saved to database.                                                                                                                                                                                                                                                                                                                                                            |
|                | Body Part Examined         | (0018,0015) | Opt  | If matched value(s) in the EXAMPLE-QUERY-RETRIEVE-SERVER exam type database then it will be saved to the database as an exam type.                                                                                                                                                                                                                                                     |

|                                 |                                |             |      |                                                                                                                                                                                                                                                                                    |
|---------------------------------|--------------------------------|-------------|------|------------------------------------------------------------------------------------------------------------------------------------------------------------------------------------------------------------------------------------------------------------------------------------|
| General Image                   | Image Type                     | (0008,0008) | Opt  | If the third value, the modality specific value, matches value(s) in the EXAMPLE-QUERY-RETRIEVE-SERVER exam type database then it will be saved to the database as an exam type.                                                                                                   |
| Image Plane                     | Pixel Spacing                  | (0028,0030) | Opt  | Used for automatic scaling of measurement tool if specified in an image SOP Instance.                                                                                                                                                                                              |
| US Region Calibration           | Sequence of Ultrasound Regions | (0018,6011) | Opt  | Used for automatic scaling of measurement tool if specified in an Ultrasound or Ultrasound Multiframe Image SOP Instance.                                                                                                                                                          |
| Image Pixel                     | Photometric Interpretation     | (0028,0004) | Cond | The following photometric interpretations are supported for image display purposes:<br>MONOCHROME1, MONOCHROME2, RGB, PALETTE COLOR, YBR FULL 422, and YBR FULL.<br>Required if SOP Instance is an Image.                                                                          |
|                                 | Bits Allocated                 | (0028,0100) | Cond | Must be 8 or 16 bits for image display purposes.<br>Required if SOP Instance is an Image.                                                                                                                                                                                          |
|                                 | Bits Stored                    | (0028,0101) | Cond | All values of 16 or fewer are supported for image display purposes.<br>Required if SOP Instance is an Image.                                                                                                                                                                       |
| Overlay Plane Module see Note 1 | Overlay Rows                   | (6000,0010) | Cond | Number of Rows in Overlay.<br>Required in order to display an Overlay.                                                                                                                                                                                                             |
|                                 | Overlay Columns                | (6000,0011) | Cond | Number of Columns in Overlay.<br>Required in order to display an Overlay.                                                                                                                                                                                                          |
|                                 | Overlay Type                   | (6000,0040) | Cond | Overlay data is used only if the value is "G", Graphics. Graphic overlay data can be automatically displayed if the system is configured to do so. "ROI", Region Of Interest, overlay data is not displayed to the user of the system.<br>Required in order to display an Overlay. |
|                                 | Overlay Origin                 | (6000,0050) | Cond | Value must be 1\1 or greater. If either Overlay Origin coordinate is less than 1 then the overlay is not displayed.<br>Required in order to display an Overlay.                                                                                                                    |
|                                 | Overlay Bits Allocated         | (6000,0100) | Cond | Must be 8 or 16 if the overlay data are embedded.<br>Required in order to display an Overlay.                                                                                                                                                                                      |
|                                 | Overlay Bit Position           | (6000,0102) | Cond | Used if the overlay data is embedded. If the data is embedded then this position must indicate a bit not used by each image pixel sample.<br>Required in order to display an Overlay.                                                                                              |
|                                 | Overlay Data                   | (6000,3000) | Cond | Overlay data present in this Element or embedded in the pixel data is supported for display.<br>Required in order to display a non-embedded Overlay.                                                                                                                               |

|            |                  |             |      |                                                                                                                                                                                                                                                                                                                                                                                                   |
|------------|------------------|-------------|------|---------------------------------------------------------------------------------------------------------------------------------------------------------------------------------------------------------------------------------------------------------------------------------------------------------------------------------------------------------------------------------------------------|
| VOI LUT    | Window Center    | (0028,1050) | Opt  | It is recommended that this value be defined for images that have greater than 8 bits stored per pixel sample for image display                                                                                                                                                                                                                                                                   |
|            | Window Width     | (0028,1051) | Opt  | It is recommended that this value be defined for images that have greater than 8 bits stored per pixel sample for image display                                                                                                                                                                                                                                                                   |
| SOP Common | SOP Instance UID | (0008,0018) | Mand | Must be provided. If a duplicate SOP Instance UID is received, the system can be configured to either coerce the duplicate value with a new UID or replace the original UID with the newly received one. The system can also be configured to either preserve the original UID or assign a new UID if the received image data is lossy compressed by the QUERY-RETRIEVE-SERVER prior to archival. |

Note 1: Note that only overlay information contained in the 6000 Group will be used for display. Overlay information contained in the other possible Groups (6002, 6004, etc.) will be ignored for display purposes. Such information will still be archived however.

#### F.8.1.2 Storage-SCU AE Element modification

The following table contains a list of all Elements that can have a value modified by the STORAGE-SCU at the time of export using the Storage Service depending on the capabilities of the receiver:

**Table F.8.1-3  
SIGNIFICANT ELEMENTS IN EXPORTED COMPOSITE SOP INSTANCES**

| Module      | Attribute Name             | Tag ID      | Value                                                                                                                                                                                                                                                                                                    |
|-------------|----------------------------|-------------|----------------------------------------------------------------------------------------------------------------------------------------------------------------------------------------------------------------------------------------------------------------------------------------------------------|
| Image Pixel | Photometric Interpretation | (0028,0004) | STORAGE-SCU AE can convert all images to MONOCHROME2 or RGB based on the configuration for the destination AE.<br><br>If the photometric interpretation of the image data is altered in a lossy manner, which could occur when converting from color to grayscale, then the SOP Instance UID is altered. |
| VOI LUT     | Window Center              | (0028,1050) | Default Window Center value can be configured for a specific destination AE.                                                                                                                                                                                                                             |
|             | Window Width               | (0028,1051) | Default Window Width value can be configured for a specific external destination AE.                                                                                                                                                                                                                     |
| SOP Common  | SOP Instance UID           | (0008,0018) | System assigns a new UID if the image data is lossy compressed by the STORAGE-SCU AE at the time of export. Unless the pixel data is lossy compressed or there is a conflict between duplicate SOP Instance UID's the original value received is not altered.                                            |



**ANNEX G (Informative)**  
**CONFORMANCE STATEMENT SAMPLE**  
**ImageViewer with Hanging Protocol Support**

Disclaimer:

This document is an example DICOM Conformance Statement for a fictional image display device for DICOM images and Hanging Protocol objects obtained over the network.

As stated in the annex title, this document is truly informative, and not normative. A conformance statement of an actual product might implement additional services and options as appropriate for its specific purpose. In addition, an actual product might implement the services described in a different manner and, for example, with different characteristics and/or sequencing of activities. In other words, this conformance statement example does not intend to standardize a particular manner that a product might implement DICOM functionality.

**G.0 COVER PAGE**

Company Name: EXAMPLE-ViewingPRODUCTS.

Product Name: SAMPLE ImageViewer with Hanging Protocol Support

Version: 1.0-rev. A.1

Internal document number: 4226-xxx-yyy-zzz rev 1

Date: YYYYMMDD

**G.1 CONFORMANCE STATEMENT OVERVIEW**

The application supports accepting Images and Presentation States from remote systems, and querying a remote system for Hanging Protocol Instances that may then be retrieved to the local system. It also supports sending locally loaded images and created Presentation State and Hanging Protocol Instances across the network to remote systems.

**Table G.1-1  
NETWORK SERVICES**

| <b>SOP Classes</b>                                         | <b>User of Service (SCU)</b> | <b>Provider of Service (SCP)</b> |
|------------------------------------------------------------|------------------------------|----------------------------------|
| <b>Transfer</b>                                            |                              |                                  |
| Ultrasound Image Storage                                   | Yes                          | Yes                              |
| Ultrasound Multi-frame Image Storage                       | Yes                          | Yes                              |
| MR Image Storage                                           | Yes                          | Yes                              |
| Digital Mammography X-Ray Image Storage – For Presentation | Yes                          | Yes                              |
| Grayscale Softcopy Presentation State Storage SOP Class    | Yes                          | Yes                              |
| Hanging Protocol Storage                                   | Yes                          | Yes                              |
| <b>Query/Retrieve</b>                                      |                              |                                  |
| Hanging Protocol Information Model – FIND                  | Yes                          | No                               |
| Hanging Protocol Information Model – MOVE                  | Yes                          | No                               |

## **G.2 TABLE OF CONTENTS**

A table of contents shall be provided to assist readers in easily finding the needed information.

## **G.3 INTRODUCTION**

### **G.3.1 Revision History**

| <b>Document Version</b> | <b>Date of Issue</b> | <b>Author</b> | <b>Description</b>     |
|-------------------------|----------------------|---------------|------------------------|
| 1.1                     | April 30, 2004       | WG 11         | Version for Final Text |
| 1.2                     | August 30, 2007      | WG 6          | Revised Introduction   |

### **G.3.2 AUDIENCE, REMARKS, TERMS AND DEFINITIONS, BASICS OF DICOM COMMUNICATION, ABBREVIATIONS, REFERENCES**

*See example text in Annex A.3.*

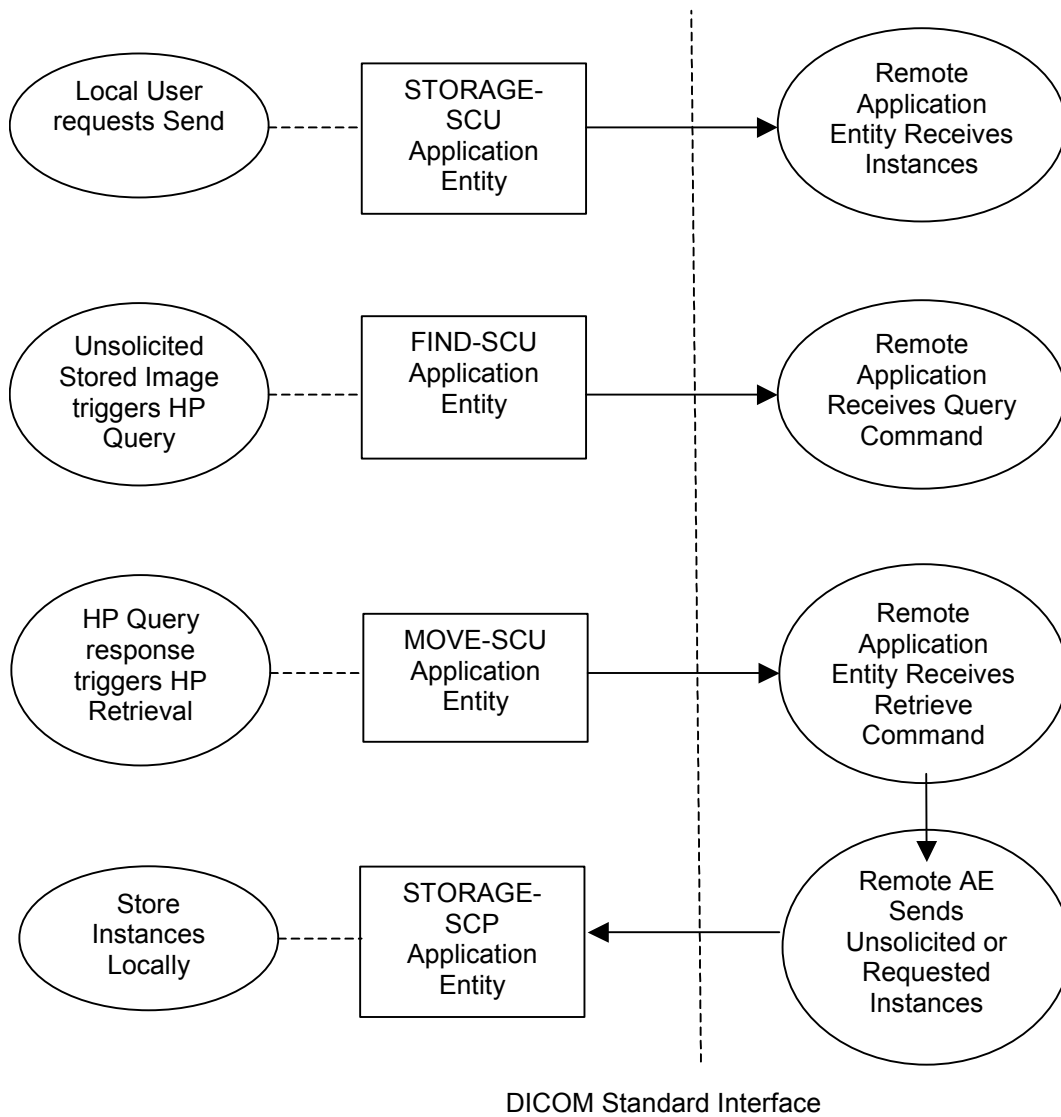
### **G.3.3 ADDITIONAL REMARKS FOR THIS EXAMPLE**

This document is a sample DICOM Conformance Statement created for DICOM PS3.2. It is to be used solely as an example to illustrate how to create a DICOM Conformance Statement for a workstation supporting a variety of types of DICOM images and DICOM Hanging Protocol objects. The subject of the document, SAMPLE IMAGE VIEWER, is a fictional product.

## G.4 NETWORKING

### G.4.1 Implementation Model

#### G.4.1.1 Application Data Flow



**Figure G.4.1-1  
Implementation Model**

The application provides both a user interface, internal database and network listener that spawns additional threads as necessary to handle incoming connections.

Conceptually the network services may be modeled as the following separate AEs, though in fact all the AEs share a single (configurable) AE Title:

- STORAGE-SCP, which receives incoming Image, Presentation State, and Hanging Protocol Instances
- STORAGE-SCU, which sends outbound Image, Presentation State, and Hanging Protocol Instances

- FIND-SCU, which queries remote AEs for Hanging Protocol Instances
- MOVE-SCU, which retrieves Hanging Protocol Instances

### G.4.1.2 Functional Definitions of AE's

#### G.4.1.2.1 STORAGE-SCP

STORAGE-SCP waits in the background for connections, will accept associations with Presentation Contexts for SOP Classes of the Storage Service Class and Hanging Protocol Storage Service Class, and will store the received instances to the local database where they may subsequently be listed and viewed through the user interface.

#### G.4.1.2.2 STORAGE-SCU

STORAGE-SCU is activated through the user interface when a user selects instances from the local database, or the currently displayed instance, and requests that they be sent to a remote AE (selected from a pre-configured list).

#### G.4.1.2.3 FIND-SCU

FIND-SCU is activated in the background when images for a study are received, to query for matching Hanging Protocols if an appropriate Hanging Protocol Instance is not available in the local database.

#### G.4.1.2.4 MOVE-SCU

MOVE-SCU is activated in the background, to retrieve Hanging Protocol Instances identified in the query results returned to the FIND-SCU. A connection to the remote AE is established to initiate and monitor the retrieval, and the STORAGE-SCP AE receives the retrieved instances.

### G.4.1.3 Sequencing of Real-World Activities

All SCP activities are performed asynchronously in the background and not dependent on any sequencing.

Storage SCU activities are sequentially initiated in the user interface, and another activity may not be initiated until the prior activity has completed. Find and Move SCU activities are performed asynchronously in the background, where Move activities are triggered by the results of Find activities.

## G.4.2 AE Specifications

### G.4.2.1 STORAGE-SCP

#### G.4.2.1.1 SOP Classes

STORAGE-SCP provide Standard Conformance to the following SOP Class(es):

**Table G.4.2-1  
SOP Classes Supported by STORAGE-SCP**

| SOP Class Name                                             | SOP Class UID                | SCU | SCP |
|------------------------------------------------------------|------------------------------|-----|-----|
| Ultrasound Image Storage                                   | 1.2.840.10008.5.1.4.1.1.6.1  | No  | Yes |
| Ultrasound Multi-frame Image Storage                       | 1.2.840.10008.5.1.4.1.1.3.1  | No  | Yes |
| MR Image Storage                                           | 1.2.840.10008.5.1.4.1.1.4    | No  | Yes |
| Digital Mammography X-Ray Image Storage – For Presentation | 1.2.840.10008.5.1.4.1.1.1.2  | No  | Yes |
| Grayscale Softcopy Presentation State Storage              | 1.2.840.10008.5.1.4.1.1.11.1 | No  | Yes |
| Hanging Protocol Storage                                   | 1.2.840.10008.5.1.4.38.1     | No  | Yes |

**G.4.2.1.2 Association Policies**

**G.4.2.1.2.1 General**

STORAGE-SCP accepts but never initiates associations.

**Table G.4.2-2  
Maximum PDU Size Received as a SCP for STORAGE-SCP**

|                           |           |
|---------------------------|-----------|
| Maximum PDU size received | Unlimited |
|---------------------------|-----------|

**G.4.2.1.2.2 Number of Associations**

**Table G.4.2-3  
Number of Associations as a SCP for STORAGE-SCP**

|                                             |           |
|---------------------------------------------|-----------|
| Maximum number of simultaneous associations | Unlimited |
|---------------------------------------------|-----------|

**G.4.2.1.2.3 Asynchronous Nature**

STORAGE-SCP will only allow a single outstanding operation on an Association. Therefore, STORAGE-SCP will not perform asynchronous operations window negotiation.

**G.4.2.1.2.4 Implementation Identifying Information**

**Table G.4.2-4  
DICOM Implementation Class and Version for STORAGE-SCP**

|                             |                    |
|-----------------------------|--------------------|
| Implementation Class UID    | 1.2.840.999999.3.6 |
| Implementation Version Name | Viewer1.0          |

**G.4.2.1.3 Association Initiation Policy**

STORAGE-SCP does not initiate associations.

**G.4.2.1.4 Association Acceptance Policy**

When STORAGE-SCP accepts an association, it will respond to storage requests. If the Called AE Title does not match the pre-configured AE Title shared by all the SCPs of the application, the association will be rejected.

**G.4.2.1.4.1 Activity – Receive Storage Request**

**G.4.2.1.4.1.1 Description and Sequencing of Activities**

As instances are received they are copied to the local file system and a record inserted into the local database. If the received instance is a duplicate of a previously received instance, the old file and database record will be overwritten with the new one.

**G.4.2.1.4.1.2 Accepted Presentation Contexts**

**Table G.4.2-5  
Accepted Presentation Contexts for  
STORAGE-SCP and Receive Storage Request**

| Presentation Context Table |                   |                           |                     |      |                      |
|----------------------------|-------------------|---------------------------|---------------------|------|----------------------|
| Abstract Syntax            |                   | Transfer Syntax           |                     | Role | Extended Negotiation |
| Name                       | UID               | Name                      | UID                 |      |                      |
| See Table G.4.2-1          | See Table G.4.2-1 | Implicit VR Little Endian | 1.2.840.10008.1.2   | SCP  | None                 |
|                            |                   | Explicit VR Little Endian | 1.2.840.10008.1.2.1 | SCP  | None                 |

#### G.4.2.1.4.1.2.1 Extended Negotiation

No extended negotiation is performed, though STORAGE-SCP:

- is a Level 2 Storage SCP (Full – does not discard any data elements)
- does not support digital signatures
- does not coerce any received data elements

#### G.4.2.1.4.1.3 SOP Specific Conformance

##### G.4.2.1.4.1.3.1 SOP Specific Conformance to Storage Service Class

STORAGE-SCP provides standard conformance to the Storage Service Class.

When displaying an image in the viewing application, if a Hanging Protocol Instance is not being applied or the instance being applied does not contain presentation intent attributes, the newest Grayscale Softcopy Presentation State containing references to the image will be automatically applied, and the GSPS Presentation Label and Presentation Description will be displayed. The user has the option to select any other Presentation States that also reference the image. If no Presentation State references the image then no Presentation State will be applied by default. If a Hanging Protocol Instance is being applied, the presentation intent attributes, if present, are used to select the closest matching GSPS instance to apply. If there is no GSPS instance, then the Hanging Protocol Instance presentation intent attributes are applied, if present.

All of the Image Storage SOP Classes listed in Table G.4.2-1 are supported as references from instances of the Grayscale Softcopy Presentation State Storage SOP Class.

##### G.4.2.1.4.1.3.2 SOP Specific Conformance to Hanging Protocol Storage Service Class

STORAGE-SCP provides standard conformance to the Hanging Protocol Storage Service Class.

If Partial Data Display Handling (0072,0208) is zero length, then MAINTAIN\_LAYOUT behavior is applied. If the value is ADAPT\_LAYOUT, then Image Boxes are proportionally resized to occupy all available display space.

If the display environment of a Hanging Protocol Instance differs from the display environment of the ImageViewer, then the layout is maintained.

The Hanging Protocol SOP instances are stored to a local database until explicitly deleted. When a study is selected for display, the application automatically applies a Hanging Protocol Instance to the study.

##### G.4.2.1.4.1.3.3 Presentation Context Acceptance Criterion

STORAGE-SCP will always accept any Presentation Context for the supported SOP Classes with the supported Transfer Syntaxes. More than one proposed Presentation Context will be accepted for the same Abstract Syntax if the Transfer Syntax is supported, whether or not it is the same as another Presentation Context.



**G.4.2.1.4.1.3.4 Transfer Syntax Selection Policies**

STORAGE-SCP prefers explicit Transfer Syntaxes. If offered a choice of Transfer Syntaxes in a Presentation Context, it will apply the following priority to the choice of Transfer Syntax:

- a. first encountered explicit Transfer Syntax,
- b. default Transfer Syntax.

STORAGE-SCP will accept duplicate Presentation Contexts, that is, if it is offered multiple Presentation Contexts, each of which offers acceptable Transfer Syntaxes, it will accept all Presentation Contexts, applying the same priority for selecting a Transfer Syntax for each.

**G.4.2.1.4.1.3.4 Response Status**

STORAGE-SCP will behave as described in the Table below when generating the C-STORE response command message.

**Table G.4.2-6  
Response Status for STORAGE-SCP and Receive Storage Request**

| Service Status | Further Meaning                          | Status Codes | Reason                                                |
|----------------|------------------------------------------|--------------|-------------------------------------------------------|
| Failure        | Refused: Out of Resources                | A700         | Never sent                                            |
|                | Error: Data Set does not match SOP Class | A900         | Never sent – data set is not checked prior to storage |
|                | Error: Cannot understand                 | C000         | Never sent                                            |
| Warning        | Coercion of Data Elements                | B000         | Never sent - no coercion is ever performed            |
|                | Data Set does not match SOP Class        | B007         | Never sent - data set is not checked prior to storage |
|                | Elements Discarded                       | B006         | Never sent – all elements are always stored           |
| Success        |                                          | 0000         |                                                       |

**G.4.2.2 STORAGE-SCU**

**G.4.2.2.1 SOP Classes**

STORAGE-SCU provides Standard Conformance to the following SOP Class(es):

**Table G.4.2-7  
SOP Classes Supported by STORAGE-SCU**

| SOP Class Name                                             | SOP Class UID               | SCU | SCP |
|------------------------------------------------------------|-----------------------------|-----|-----|
| Ultrasound Image Storage                                   | 1.2.840.10008.5.1.4.1.1.6.1 | Yes | No  |
| Ultrasound Multi-frame Image Storage                       | 1.2.840.10008.5.1.4.1.1.3.1 | Yes | No  |
| MR Image Storage                                           | 1.2.840.10008.5.1.4.1.1.4   | Yes | No  |
| Digital Mammography X-Ray Image Storage – For Presentation | 1.2.840.10008.5.1.4.1.1.1.2 | Yes | No  |

| SOP Class Name                                | SOP Class UID                | SCU | SCP |
|-----------------------------------------------|------------------------------|-----|-----|
| Grayscale Softcopy Presentation State Storage | 1.2.840.10008.5.1.4.1.1.11.1 | Yes | No  |
| Hanging Protocol Storage                      | 1.2.840.10008.5.1.4.38.1     | Yes | No  |

**G.4.2.2.2 Association Policies**

**G.4.2.2.2.1 General**

STORAGE-SCU initiates but never accepts associations.

**Table G.4.2-8  
Maximum PDU Size Received as a SCP for STORAGE-SCU**

|                           |           |
|---------------------------|-----------|
| Maximum PDU size received | Unlimited |
|---------------------------|-----------|

**G.4.2.2.2.2 Number of Associations**

**Table G.4.2-9  
Number of Associations as a SCP for STORAGE-SCU**

|                                             |   |
|---------------------------------------------|---|
| Maximum number of simultaneous associations | 1 |
|---------------------------------------------|---|

**G.4.2.2.2.3 Asynchronous Nature**

STORAGE-SCU will only allow a single outstanding operation on an Association. Therefore, STORAGE-SCU will not perform asynchronous operations window negotiation.

**G.4.2.2.2.4 Implementation Identifying Information**

**Table G.4.2-10  
DICOM Implementation Class and Version for STORAGE-SCU**

|                             |                    |
|-----------------------------|--------------------|
| Implementation Class UID    | 1.2.840.999999.3.6 |
| Implementation Version Name | Viewer1.0          |

**G.4.2.2.3 Association Initiation Policy**

STORAGE-SCU attempts to initiate a new association for each instance it attempts to transfer.

**G.4.2.2.3.1 Activity – Send Storage Request**

**G.4.2.2.3.1.1 Description and Sequencing of Activities**

For each Image, Presentation State, or Hanging Protocol Instance selected from the user interface to be transferred, a single attempt will be made to transmit it to the selected remote AE. If the send fails, for whatever reason, no retry will be performed, and an attempt will be made to send the next instance.

**G.4.2.2.3.1.2 Proposed Presentation Contexts**

**Table G.4.2-11  
Proposed Presentation Contexts for STORAGE-SCU and Receive Storage Request**

| Presentation Context Table |                   |                           |                     |      |                      |
|----------------------------|-------------------|---------------------------|---------------------|------|----------------------|
| Abstract Syntax            |                   | Transfer Syntax           |                     | Role | Extended Negotiation |
| Name                       | UID               | Name                      | UID                 |      |                      |
| See Table G.4.2-7          | See Table G.4.2-7 | Implicit VR Little Endian | 1.2.840.10008.1.2   | SCU  | None                 |
|                            |                   | Explicit VR Little Endian | 1.2.840.10008.1.2.1 | SCU  | None                 |

STORAGE-SCU will propose Presentation Contexts only for the SOP Class of the instance that is to be transferred.

For that SOP Class, STORAGE-SCU will propose multiple Presentation Contexts, one for each of the supported Transfer Syntaxes, and an additional Presentation Context with all of the supported Transfer Syntaxes, in order to determine which Transfer Syntaxes the remote SCP supports, and which it prefers.

#### G.4.2.2.3.1.2.1 Extended Negotiation

No extended negotiation is performed.

#### G.4.2.2.3.1.3 SOP Specific Conformance

##### G.4.2.2.3.1.3.1 SOP Specific Conformance to Storage Service Class

STORAGE-SCU provides standard conformance to the Storage Service Class.

##### G.4.2.2.3.1.3.2 SOP Specific Conformance to Hanging Protocol Storage Service Class

STORAGE-SCU provides standard conformance to the Hanging Protocol Storage Service Class.

In Hanging Protocol Instances created on the Viewer, no Private Attributes are used as the value of Selector Attribute (0072,0026) in any of the Sequence Attributes to which it applies.

##### G.4.2.2.3.1.3.3 Presentation Context Acceptance Criterion

STORAGE-SCU does not accept associations.

##### G.4.2.2.3.1.3.4 Transfer Syntax Selection Policies

STORAGE-SCU prefers explicit Transfer Syntaxes. If offered a choice of Transfer Syntaxes in the accepted Presentation Contexts, it will apply the following priority to the choice of Presentation Context to use for the C-STORE operation:

- a. first encountered explicit Transfer Syntax,
- b. default Transfer Syntax.

##### G.4.2.2.3.1.3.4 Response Status

STORAGE-SCU will behave as described in the Table below in response to the status returned in the C-STORE response command message.

**Table G.4.2-12  
Response Behavior for STORAGE-SCU and Send Storage Request**

| Service Status | Further Meaning           | Status Codes | Behavior                                       |
|----------------|---------------------------|--------------|------------------------------------------------|
| Failure        | Refused: Out of Resources | A7xx         | The user is notified and the failure is logged |

|         |                                          |      |                                                |
|---------|------------------------------------------|------|------------------------------------------------|
|         | Error: Data Set does not match SOP Class | A9xx | The user is notified and the failure is logged |
|         | Error: Cannot understand                 | Cxxx | The user is notified and the failure is logged |
| Warning | Coercion of Data Elements                | B000 | Ignored                                        |
|         | Data Set does not match SOP Class        | B007 | Ignored                                        |
|         | Elements Discarded                       | B006 | Ignored                                        |
| Success |                                          | 0000 | Ignored                                        |

**G.4.2.2.4 Association Acceptance Policy**

STORAGE-SCU does not accept associations.

**G.4.2.3 FIND-SCU**

**G.4.2.3.1 SOP Classes**

FIND-SCU provide Standard Conformance to the following SOP Class(es):

**Table G.4.2-13  
SOP Classes Supported by FIND-SCU**

| SOP Class Name                            | SOP Class UID            | SCU | SCP |
|-------------------------------------------|--------------------------|-----|-----|
| Hanging Protocol Information Model – FIND | 1.2.840.10008.5.1.4.38.2 | Yes | No  |

**G.4.2.3.2 Association Policies**

**G.4.2.3.2.1 General**

FIND-SCU initiates but never accepts associations.

**Table G.4.2-14  
Maximum PDU Size Received as a SCP for FIND-SCU**

|                           |           |
|---------------------------|-----------|
| Maximum PDU size received | Unlimited |
|---------------------------|-----------|

**G.4.2.3.2.2 Number of Associations**

**Table G.4.2-15  
Number of Associations as a SCP for FIND-SCU**

|                                             |   |
|---------------------------------------------|---|
| Maximum number of simultaneous associations | 1 |
|---------------------------------------------|---|

**G.4.2.3.2.3 Asynchronous Nature**

FIND-SCU will only allow a single outstanding operation on an Association. Therefore, FIND-SCU will not perform asynchronous operations window negotiation.

**G.4.2.3.2.4 Implementation Identifying Information**

**Table G.4.2-16  
DICOM Implementation Class and Version for FIND-SCU**

|                             |                    |
|-----------------------------|--------------------|
| Implementation Class UID    | 1.2.840.999999.3.6 |
| Implementation Version Name | Viewer1.0          |

**G.4.2.3.3 Association Initiation Policy**

FIND-SCU attempts to initiate a new association when a study is received for which an appropriate Hanging Protocol Instance is not already stored in the local database.

**G.4.2.3.3.1 Activity – Query Remote AE**

**G.4.2.3.3.1.1 Description and Sequencing of Activities**

A single attempt will be made to query the remote AE. If the query fails, for whatever reason, no retry will be performed.

**G.4.2.3.3.1.2 Proposed Presentation Contexts**

**Table G.4.2-17  
Proposed Presentation Contexts for FIND-SCU and Query Remote AE**

| Presentation Context Table |                    |                           |                     |      |                      |
|----------------------------|--------------------|---------------------------|---------------------|------|----------------------|
| Abstract Syntax            |                    | Transfer Syntax           |                     | Role | Extended Negotiation |
| Name                       | UID                | Name                      | UID                 |      |                      |
| See Table G.4.2-13         | See Table G.4.2-13 | Implicit VR Little Endian | 1.2.840.10008.1.2   | SCU  | None                 |
|                            |                    | Explicit VR Little Endian | 1.2.840.10008.1.2.1 | SCU  | None                 |

FIND-SCU will propose multiple Presentation Contexts, one for each of the supported Transfer Syntaxes, and an additional Presentation Context with all of the supported Transfer Syntaxes, in order to determine which Transfer Syntaxes the remote SCP supports, and which it prefers.

**G.4.2.3.3.1.2.1 Extended Negotiation**

No extended negotiation is performed.

**G.4.2.3.3.1.3 SOP Specific Conformance**

**G.4.2.3.3.1.3.1 SOP Specific Conformance to C-FIND SOP Classes**

FIND-SCU provides standard conformance to the supported C-FIND SOP Class.

The following applies to Hanging Protocol Information Model C-FIND.

If present in the response, Specific Character Set will be used to identify character sets other than the default character set for matching between Hanging Protocol and Image Instances.

| Name                  | Tag         | Types of Matching |
|-----------------------|-------------|-------------------|
| SOP Class UID         | (0008,0016) | zero length       |
| SOP Instance UID      | (0008,0018) | zero length       |
| Hanging Protocol Name | (0072,0002) | S, *, U           |

| Name                                               | Tag         | Types of Matching                             |
|----------------------------------------------------|-------------|-----------------------------------------------|
| Hanging Protocol Description                       | (0072,0004) | zero length                                   |
| Hanging Protocol Level                             | (0072,0006) | S, U                                          |
| Hanging Protocol Creator                           | (0072,0008) | zero length                                   |
| Hanging Protocol Creation Datetime                 | (0072,000A) | zero length                                   |
| Hanging Protocol Definition Sequence               | (0072,000C) | SQ, U                                         |
| >Modality                                          | (0008,0060) | From list (US, MR, MG) or zero length         |
| >Anatomic Region Sequence                          | (0008,2218) | From CID 4, PS 3.16 or zero length            |
| >> Code Value                                      | (0008,0100) | S, U                                          |
| >> Coding Scheme Designator                        | (0008,0102) | S, U                                          |
| >>Coding Scheme Version                            | (0008,0103) | zero length                                   |
| >>Code Meaning                                     | (0008,0104) | zero length                                   |
| >Laterality                                        | (0020,0060) | From list (R, L, U, B) or zero length         |
| > Procedure Code Sequence                          | (0008,1032) | zero length                                   |
| >Reason for Requested Procedure Code Sequence      | (0040,100A) | zero length                                   |
| Number of Priors Referenced                        | (0072,0014) | zero length                                   |
| Hanging Protocol User Identification Code Sequence | (0072,000E) | From list of local coded terms or zero length |
| >Code Value                                        | (0008,0100) | S, U                                          |
| >Coding Scheme Designator                          | (0008,0102) | S, U                                          |
| >Coding Scheme Version                             | (0008,0103) | zero length                                   |
| >Code Meaning                                      | (0008,0104) | zero length                                   |
| Hanging Protocol User Group Name                   | (0072,0010) | zero length                                   |
| Number of Screens                                  | (0072,0100) | zero length                                   |
| Nominal Screen Definition Sequence                 | (0072,0102) | zero length                                   |

#### G.4.2.3.3.1.3.2 Presentation Context Acceptance Criterion

FIND-SCU does not accept associations.

**G.4.2.3.3.1.3.3 Transfer Syntax Selection Policies**

FIND-SCU prefers explicit Transfer Syntaxes. If offered a choice of Transfer Syntaxes in the accepted Presentation Contexts, it will apply the following priority to the choice of Presentation Context to use for the C-FIND operation:

- a. first encountered explicit Transfer Syntax,
- b. default Transfer Syntax.

**G.4.2.3.3.1.3.4 Response Status**

FIND-SCU will behave as described in Table G.4.2-19 in response to the status returned in the C-FIND response command message(s).

**Table G.4.2-19  
Response Status for FIND-SCU and Query Remote AE Request**

| <b>Service Status</b> | <b>Further Meaning</b>                                                                                                               | <b>Status Codes</b> | <b>Behavior</b>                                                                                                                                                                         |
|-----------------------|--------------------------------------------------------------------------------------------------------------------------------------|---------------------|-----------------------------------------------------------------------------------------------------------------------------------------------------------------------------------------|
| Refused               | Out of Resources                                                                                                                     | A700                | Current query is terminated; remaining queries continue                                                                                                                                 |
| Error                 | Identifier does not match SOP Class                                                                                                  | A900                | Current query is terminated; remaining queries continue                                                                                                                                 |
|                       | Unable to process                                                                                                                    | Cxxx                | Current query is terminated; remaining queries continue                                                                                                                                 |
| Cancel                | Matching terminated due to Cancel request                                                                                            | FE00                | Ignored (should never occur, since cancels never issued)                                                                                                                                |
| Success               | Matching is complete - No final Identifier is supplied                                                                               | 0000                | Current query is terminated. If one or more Pending responses were received, logic is applied to trigger Retrieve of best suited Hanging Protocol Instances; remaining queries continue |
| Pending               | Matches are continuing - Current Match is supplied and any Optional Keys were supported in the same manner as Required Keys          | FF00                | Identifier stored temporarily for use in setting up Retrieve.                                                                                                                           |
|                       | Matches are continuing - Warning that one or more Optional Keys were not supported for existence and/or matching for this Identifier | FF01                | Identifier stored temporarily for use in setting up Retrieve                                                                                                                            |

**G.4.2.3.4 Association Acceptance Policy**

FIND-SCU does not accept associations.

**G.4.2.4 MOVE-SCU**

**G.4.2.4.1 SOP Classes**

MOVE-SCU provide Standard Conformance to the following SOP Class(es):

**Table G.4.2-20  
SOP Classes Supported by MOVE-SCU**

| SOP Class Name                            | SOP Class UID            | SCU | SCP |
|-------------------------------------------|--------------------------|-----|-----|
| Hanging Protocol Information Model – MOVE | 1.2.840.10008.5.1.4.38.3 | Yes | No  |

**G.4.2.4.2 Association Policies**

**G.4.2.4.2.1 General**

MOVE-SCU initiates but never accepts associations.

**Table G.4.2-21  
Maximum PDU Size Received as a SCP for MOVE-SCU**

|                           |           |
|---------------------------|-----------|
| Maximum PDU size received | Unlimited |
|---------------------------|-----------|

**G.4.2.4.2.2 Number of Associations**

**Table G.4.2-27  
Number of Associations as a SCP for MOVE-SCU**

|                                             |   |
|---------------------------------------------|---|
| Maximum number of simultaneous associations | 1 |
|---------------------------------------------|---|

**G.4.2.4.2.3 Asynchronous Nature**

MOVE-SCU will only allow a single outstanding operation on an Association. Therefore, MOVE-SCU will not perform asynchronous operations window negotiation.

**G.4.2.4.2.4 Implementation Identifying Information**

**Table G.4.2-23  
DICOM Implementation Class and Version for MOVE-SCU**

|                             |                    |
|-----------------------------|--------------------|
| Implementation Class UID    | 1.2.840.999999.3.6 |
| Implementation Version Name | Viewer1.0          |

**G.4.2.4.3 Association Initiation Policy**

MOVE-SCU attempts to initiate a new association when the results of the FIND-SCU indicate matching Hanging Protocol Instances to retrieve.

**G.4.2.4.3.1 Activity – Retrieve From Remote AE**

**G.4.2.4.3.1.1 Description and Sequencing of Activities**

A single attempt will be made to retrieve Hanging Protocol Instances from the remote AE. If the retrieve fails, for whatever reason, no retry will be performed.

**G.4.2.4.3.1.2 Proposed Presentation Contexts**

**Table G.4.2-24  
Proposed Presentation Contexts for MOVE-SCU and Retrieve From Remote AE**

- Standard -



| Presentation Context Table |                    |                           |                     |      |                      |
|----------------------------|--------------------|---------------------------|---------------------|------|----------------------|
| Abstract Syntax            |                    | Transfer Syntax           |                     | Role | Extended Negotiation |
| Name                       | UID                | Name                      | UID                 |      |                      |
| See Table G.4.2-20         | See Table G.4.2-20 | Implicit VR Little Endian | 1.2.840.10008.1.2   | SCP  | None                 |
|                            |                    | Explicit VR Little Endian | 1.2.840.10008.1.2.1 | SCP  | None                 |

MOVE-SCU will propose multiple Presentation Contexts, one for each of the supported Transfer Syntaxes, and an additional Presentation Context with all of the supported Transfer Syntaxes, in order to determine which Transfer Syntaxes the remote SCP supports, and which it prefers.

**G.4.2.4.3.1.2.1 Extended Negotiation**

No extended negotiation is performed.

**G.4.2.4.3.1.3 SOP Specific Conformance**

**G.4.2.4.3.1.3.1 SOP Specific Conformance to C-FIND SOP Classes**

MOVE-SCU provides standard conformance to the supported C-MOVE SOP Class.

No CANCEL requests are ever issued.

The retrieval is performed from the AE that was specified in the Retrieve AE attribute returned from the query performed by FIND-SCU. The instances are retrieved to the current application's local database by specifying the destination as the AE Title of the STORE-SCP AE of the local application. This implies that the remote C-MOVE SCP must be preconfigured to determine the presentation address corresponding to the STORE-SCP AE. The STORE-SCP AE will accept storage requests addressed to it from anywhere, so no pre-configuration of the local application to accept from the remote AE is necessary (except in so far as it was necessary to configure FIND-SCU).

**Table G.4.2-25  
Request Identifier for MOVE-SCU**

| Name                    | Tag         | Request Key  |
|-------------------------|-------------|--------------|
| <b>Hanging Protocol</b> |             |              |
| SOP Instance UID        | (0008,0018) | List of UIDs |

**G.4.2.4.3.1.3.2 Presentation Context Acceptance Criterion**

MOVE-SCU does not accept associations.

**G.4.2.4.3.1.3.3 Transfer Syntax Selection Policies**

MOVE-SCU prefers explicit Transfer Syntaxes. If offered a choice of Transfer Syntaxes in the accepted Presentation Contexts, it will apply the following priority to the choice of Presentation Context to use for the C-MOVE operation:

- a. first encountered explicit Transfer Syntax,
- b. default Transfer Syntax.

**G.4.2.4.3.1.3.4 Response Status**

MOVE-SCU will behave as described in the Table below in response to the status returned in the C-MOVE response command message(s).

**Table G.4.2-26  
Response Status for MOVE-SCU and Retrieve From Remote AE Request**

| <b>Service Status</b> | <b>Further Meaning</b>                                   | <b>Status Codes</b> | <b>Related Fields</b>                                    | <b>Behavior</b>                                                          |
|-----------------------|----------------------------------------------------------|---------------------|----------------------------------------------------------|--------------------------------------------------------------------------|
| Refused               | Out of Resources - Unable to calculate number of matches | A701                | (0000,0902)                                              | Retrieval is terminated                                                  |
|                       | Out of Resources - Unable to perform sub-operations      | A702                | (0000,1020)<br>(0000,1021)<br>(0000,1022)<br>(0000,1023) | Retrieval is terminated                                                  |
|                       | Move Destination unknown                                 | A801                | (0000,0902)                                              | Retrieval is terminated                                                  |
| Failed                | Identifier does not match SOP Class                      | A900                | (0000,0901)<br>(0000,0902)                               | Retrieval is terminated                                                  |
|                       | Unable to process                                        | Cxxx                | (0000,0901)<br>(0000,0902)                               | Retrieval is terminated                                                  |
| Cancel                | Sub-operations terminated due to Cancel Indication       | FE00                | (0000,1020)<br>(0000,1021)<br>(0000,1022)<br>(0000,1023) | Retrieval is terminated (should never occur, since cancels never issued) |
| Warning               | Sub-operations Complete - One or more Failures           | B000                | (0000,1020)<br>(0000,1022)<br>(0000,1023)                | Retrieval is terminated                                                  |
| Success               | Sub-operations Complete - No Failures                    | 0000                | (0000,1020)<br>(0000,1021)<br>(0000,1022)<br>(0000,1023) | Retrieval is terminated                                                  |
| Pending               | Sub-operations are continuing                            | FF00                | (0000,1020)<br>(0000,1021)<br>(0000,1022)<br>(0000,1023) | Retrieval continues                                                      |

**G.4.2.4.3.1.3.5 Sub-operation dependent behavior**

Since the C-MOVE operation is dependent on completion of C-STORE sub-operations that are occurring on a separate association, the question of failure of operations on the other association(s) must be considered.

MOVE-SCU completely ignores whatever activities are taking place in relation to the STORAGE-SCP AE that is receiving the retrieved instances. Once the C-MOVE has been initiated it runs to completion (or failure) as described in the C-MOVE response command message(s). There is no attempt by MOVE-SCU to confirm that instances have actually been successfully received or locally stored.

Whether or not completely or partially successfully retrievals are made available in the local database to the user is purely dependent on the success or failure of the C-STORE sub-operations, not on any explicit action by MOVE-SCU.

Whether or not the remote AE attempts to retry any failed C-STORE sub-operations is beyond the control of MOVE-SCU.

If the association on which the C-MOVE was issued is aborted for any reason, whether or not the C-STORE sub-operations continue is dependent on the remote AE; the local STORAGE-SCP will continue to accept associations and storage operations regardless.

**G.4.2.4.4 Association Acceptance Policy**

MOVE-SCU does not accept associations.

**G.4.3 Network Interfaces**

**G.4.3.1 Physical Network Interface**

The application is indifferent to the physical medium over which TCP/IP executes; which is dependent on the underlying operating system and hardware.

**G.4.3.2 Additional Protocols**

When host names rather than IP addresses are used in the configuration properties to specify presentation addresses for remote AEs, the application is dependent on the name resolution mechanism of the underlying operating system.

**G.4.3.3 IPv4 and IPv6 Support**

This product supports both IPv4 and IPv6. It does not utilize any of the optional configuration identification or security features of IPv6.

**G.4.4 Configuration**

All configuration is performed through the use of Java properties file(s) stored in pre-defined locations that are specific to the underlying operating system. Refer to the Release Notes for specific details.

**G.4.4.1 AE Title/Presentation Address Mapping**

The Calling AE Titles of the local application are configurable in the preferences file. The mapping of the logical name by which remote AEs are described in the user interface to Called AE Titles as well as presentation address (hostname or IP address and port number) is configurable in the preferences file.

**G.4.4.2 Parameters**

**Table G.4.4-1  
Configuration Parameters Table**

| Parameter                                                                                                         | Configurable | Default Value |
|-------------------------------------------------------------------------------------------------------------------|--------------|---------------|
| <b>General Parameters</b>                                                                                         |              |               |
| PDU Size                                                                                                          | No           | 16kB          |
| Time-out waiting for acceptance or rejection Response to an Association Open Request. (Application Level timeout) | No           | None          |
| General DIMSE level time-out values                                                                               | No           | None          |
| Time-out waiting for response to TCP/IP connect() request. (Low-level timeout)                                    | No           | None          |
| Time-out waiting for acceptance of a TCP/IP message over the network. (Low-level timeout)                         | No           | None          |
| Time-out for waiting for data between TCP/IP packets. (Low-level timeout)                                         | No           | None          |
| Any changes to default TCP/IP settings, such as configurable stack parameters.                                    | No           | None          |

| Parameter                                                       | Configurable | Default Value                                                |
|-----------------------------------------------------------------|--------------|--------------------------------------------------------------|
| <b>General Parameters</b>                                       |              |                                                              |
| <b>AE Specific Parameters (all AEs)</b>                         |              |                                                              |
| Size constraint in maximum object size                          | No           | None                                                         |
| Maximum PDU size the AE can receive (see note 1)                | No           | Unlimited                                                    |
| Maximum PDU size the AE can send                                | No           | Unlimited                                                    |
| AE specific DIMSE level time-out values                         | No           | None                                                         |
| Number of simultaneous Associations by Service and/or SOP Class | No           | Unlimited                                                    |
| SOP Class support                                               | No           | All supported SOP Classes always proposed and accepted       |
| Transfer Syntax support                                         | No           | All supported Transfer Syntaxes always proposed and accepted |
| Other parameters that are configurable                          | No           | None                                                         |

Notes: 1. Though the application can support unlimited PDU sizes, it will never offer a Maximum Received PDU Length of zero (unlimited) since this triggers a bug in some older systems.

## G.5 MEDIA INTERCHANGE

None supported.

## G.6 SUPPORT OF CHARACTER SETS

### G.6.1 Overview

Support extends to correctly decoding and displaying the correct symbol in the supported character sets for all names and strings received over the network, and in the local database.

No specific support for sorting of strings other than in the default character set is provided in the browsers.

### G.6.2 Character Sets

In addition to the default character repertoire, the Defined Terms for Specific Character Set in Table G.6.2-1 are supported:

**Table G.6.2-1  
Supported Specific Character Set Defined Terms**

| Character Set Description | Defined Term |
|---------------------------|--------------|
| Latin alphabet No. 1      | ISO_IR 100   |

### G.6.3 Character Set Configuration

Whether or not characters are displayed correctly depends on the presence of font support in the underlying operating system.

## G.7 SECURITY

### G.7.1 Security Profiles

None supported.

### G.7.2 Association Level Security

None supported.

Any Calling AE Titles and/or IP addresses may open an Association.

### G.7.3 Application Level Security

None supported.

## G.8 ANNEXES

### G.8.1 IOD Contents

#### G.8.1.1 Created SOP Instances

Table G.8.1-1 specifies the attributes of a Hanging Protocol Instance transmitted by the ImageViewer application.

The following tables use a number of abbreviations. The abbreviations used in the "Presence of ..." column are:

|        |                                                                              |
|--------|------------------------------------------------------------------------------|
| VNAP   | Value Not Always Present (attribute sent zero length if no value is present) |
| ANAP   | Attribute Not Always Present                                                 |
| ALWAYS | Always Present                                                               |

EMPTY Attribute is sent without a value

The abbreviations used in the “Source” column:

USER the attribute value source is from User input

AUTO the attribute value is generated automatically

CONFIG the attribute value source is a configurable parameter

NOTE: All dates and times are encoded in the local configured calendar and time. Date, Time and Time zone are configured using the Service/Installation Tool.

**G.8.1.1.1 Hanging Protocol IOD**

**Table G.8.1-1**

**IOD OF CREATED HANGING PROTOCOL SOP INSTANCES**

| IE               | Module                       | Reference     | Presence of Module |
|------------------|------------------------------|---------------|--------------------|
| Hanging Protocol | SOP Common                   | Table G.8.1-2 | ALWAYS             |
|                  | Hanging Protocol Definition  | Table G.8.1-3 | ALWAYS             |
|                  | Hanging Protocol Environment | Table G.8.1-4 | ALWAYS             |
|                  | Hanging Protocol Display     | Table G.8.1-5 | ALWAYS             |

**Table G.8.1-2**

**SOP COMMON MODULE OF CREATED SOP INSTANCES**

| Attribute Name         | Tag         | VR | Value                    | Presence of Value | Source |
|------------------------|-------------|----|--------------------------|-------------------|--------|
| Specific Character Set | (0008,0005) | CS | From Table G.6.2-1       | ALWAYS            | CONFIG |
| SOP Class UID          | (0008,0016) | UI | 1.2.840.10008.5.1.4.38.1 | ALWAYS            | AUTO   |
| SOP Instance UID       | (0008,0018) | UI | Generated by device      | ALWAYS            | AUTO   |

**Table G.8.1-3**

**HANGING PROTOCOL DEFINITION MODULE OF CREATED SOP INSTANCES**

| Attribute Name        | Tag         | VR | Value            | Presence of Value | Source |
|-----------------------|-------------|----|------------------|-------------------|--------|
| Hanging Protocol Name | (0072,0002) | SH | From user input. | ALWAYS            | USER   |

| Attribute Name                                                                                                                   | Tag         | VR | Value                                                                                                       | Presence of Value | Source    |
|----------------------------------------------------------------------------------------------------------------------------------|-------------|----|-------------------------------------------------------------------------------------------------------------|-------------------|-----------|
| Hanging Protocol Description                                                                                                     | (0072,0004) | LO | From user input.                                                                                            | ALWAYS            | USER      |
| Hanging Protocol Level                                                                                                           | (0072,0006) | CS | From user input.                                                                                            | ALWAYS            | USER      |
| Hanging Protocol Creator                                                                                                         | (0072,0008) | LO | From user login.                                                                                            | ALWAYS            | AUTO      |
| Hanging Protocol Creation Datetime                                                                                               | (0072,000A) | DT | Generated by device.                                                                                        | ALWAYS            | AUTO      |
| Hanging Protocol Definition Sequence                                                                                             | (0072,000C) | SQ | One or more sequence items.                                                                                 | ALWAYS            | AUTO      |
| >Modality                                                                                                                        | (0008,0060) | CS | From Defined Terms, based on user input.                                                                    | ANAP              | USER/AUTO |
| >Anatomic Region Sequence                                                                                                        | (0008,2218) | SQ | One or more sequence items, based on user input.                                                            | ANAP              | USER/AUTO |
| >>Include 'Code Sequence Macro'                                                                                                  |             |    | Defined Context ID 4                                                                                        |                   |           |
| >Laterality                                                                                                                      | (0020,0060) | CS | R, L, B, U or zero length, based on user input.                                                             | ANAP              | USER/AUTO |
| > Procedure Code Sequence                                                                                                        | (0008,1032) | SQ | Zero length.                                                                                                | EMPTY             | AUTO      |
| >Reason for Requested Procedure Code Sequence                                                                                    | (0040,100A) | SQ | Zero length.                                                                                                | EMPTY             | AUTO      |
| Number of Priors Referenced                                                                                                      | (0072,0014) | US | Numeric value.                                                                                              | ALWAYS            | AUTO      |
| Image Sets Sequence                                                                                                              | (0072,0020) | SQ | One or more sequence items.                                                                                 | ALWAYS            | AUTO      |
| >Image Set Selector Sequence                                                                                                     | (0072,0022) | SQ | One or more sequence items.                                                                                 | ALWAYS            | AUTO      |
| >>Image Set Selector Usage Flag                                                                                                  | (0072,0024) | CS | MATCH or NO_MATCH, depending on Selector Attribute.                                                         | ALWAYS            | AUTO      |
| >>Selector Attribute                                                                                                             | (0072,0026) | AT | Relevant Attribute Tags from DICOM Data Dictionary.                                                         | ALWAYS            | AUTO      |
| >>Selector Sequence Pointer                                                                                                      | (0072,0052) | AT | Relevant Sequence Attribute Tags from DICOM Data Dictionary, if Selector Attribute is nested in a Sequence. | ANAP              | AUTO      |
| >>Selector Attribute VR                                                                                                          | (0072,0050) | CS | VR of Selector Attribute                                                                                    | ALWAYS            | AUTO      |
| >>The attribute from the Hanging Protocol Selector Attribute Value Macro that is required by the value of Selector Attribute VR. |             |    |                                                                                                             | ALWAYS            | AUTO      |
| >>Selector Value Number                                                                                                          | (0072,0028) | US | 0,1-n                                                                                                       | ALWAYS            | AUTO      |
| >Time Based Image Sets Sequence                                                                                                  | (0072,0030) | SQ | One or more sequence items.                                                                                 | ALWAYS            | AUTO      |
| >>Image Set Number                                                                                                               | (0072,0032) | US | Generated by device.                                                                                        | ALWAYS            | AUTO      |
| >>Image Set Selector Category                                                                                                    | (0072,0034) | CS | RELATIVE_TIME or ABSTRACT_PRIOR, based on user input.                                                       | ALWAYS            | AUTO      |

| Attribute Name                                     | Tag         | VR | Value                              | Presence of Value | Source    |
|----------------------------------------------------|-------------|----|------------------------------------|-------------------|-----------|
| >>Relative Time                                    | (0072,0038) | US | From user input.                   | ANAP              | USER      |
| >>Relative Time Units                              | (0072,003A) | CS | From user input.                   | ANAP              | USER      |
| >>Abstract Prior Value                             | (0072,003C) | SS | From user input.                   | ANAP              | USER      |
| >>Image Set Label                                  | (0072,0040) | LO | From user input.                   | ANAP              | USER      |
| Hanging Protocol User Identification Code Sequence | (0072,000E) | SQ | One sequence item.                 | ALWAYS            | USER/AUTO |
| >>Include 'Code Sequence Macro'                    |             |    | <i>Local coded terms for users</i> |                   |           |
| Hanging Protocol User Group Name                   | (0072,0010) | LO | From user input.                   | ANAP              | USER/AUTO |

**Table G.8.1-4**

**HANGING PROTOCOL ENVIRONMENT MODULE OF CREATED SOP INSTANCES**

| Attribute Name                        | Tag         | VR | Value                                                                | Presence of Value | Source |
|---------------------------------------|-------------|----|----------------------------------------------------------------------|-------------------|--------|
| Number of Screens                     | (0072,0100) | US | 2                                                                    | ALWAYS            | AUTO   |
| Nominal Screen Definition Sequence    | (0072,0102) | SQ | Two sequence items.                                                  | ALWAYS            | AUTO   |
| >Number of Vertical Pixels            | (0072,0104) | US | 1024                                                                 | ALWAYS            | AUTO   |
| >Number of Horizontal Pixels          | (0072,0106) | US | 1280                                                                 | ALWAYS            | AUTO   |
| >Display Environment Spatial Position | (0072,0108) | FD | Sequence Item 1: 0.0 1.0 0.5 0.0<br>Sequence Item 2: 0.5 1.0 1.0 0.0 | ALWAYS            | AUTO   |
| >Screen Minimum Color Bit Depth       | (0072,010C) | US | 8                                                                    | ALWAYS            | AUTO   |

**Table G.8.1-5**

**HANGING PROTOCOL DISPLAY MODULE OF CREATED SOP INSTANCES**

| Attribute Name                  | Tag         | VR | Value                       | Presence of Value | Source |
|---------------------------------|-------------|----|-----------------------------|-------------------|--------|
| Display Sets Sequence           | (0072,0200) | SQ | One or more sequence items. | ALWAYS            | AUTO   |
| >Display Set Number             | (0072,0202) | US | Generated by device.        | ALWAYS            | AUTO   |
| >Display Set Label              | (0072,0203) | LO | From user input             | ANAP              | USER   |
| >Display Set Presentation Group | (0072,0204) | US | 1                           | ALWAYS            | AUTO   |
| >Image Set Number               | (0072,0032) | US | Determined by application.  | ALWAYS            | AUTO   |
| >Image Boxes Sequence           | (0072,0300) | SQ | One sequence item.          | ALWAYS            | AUTO   |



| Attribute Name                                                                                                                               | Tag         | VR | Value                                                                                                                                                                                  | Presence of Value | Source    |
|----------------------------------------------------------------------------------------------------------------------------------------------|-------------|----|----------------------------------------------------------------------------------------------------------------------------------------------------------------------------------------|-------------------|-----------|
| >>Image Box Number                                                                                                                           | (0072,0302) | US | Generated by device.                                                                                                                                                                   | ALWAYS            | AUTO      |
| >>Display Environment Spatial Position                                                                                                       | (0072,0108) | FD | Determined by application with user input.                                                                                                                                             | ALWAYS            | AUTO      |
| >>Image Box Layout Type                                                                                                                      | (0072,0304) | CS | TILED, STACK or SINGLE, determined by application with user input.                                                                                                                     | ALWAYS            | AUTO      |
| >>Image Box Tile Horizontal Dimension                                                                                                        | (0072,0306) | US | For TILED, determined by application with user input.                                                                                                                                  | ANAP              | AUTO      |
| >>Image Box Tile Vertical Dimension                                                                                                          | (0072,0308) | US | For TILED, determined by application with user input.                                                                                                                                  | ANAP              | AUTO      |
| >>Image Box Scroll Direction                                                                                                                 | (0072,0310) | CS | For TILED, VERTICAL or HORIZONTAL, determined by application with user input.                                                                                                          | ANAP              | AUTO      |
| >>Image Box Small Scroll Type                                                                                                                | (0072,0312) | CS | For TILED only, value is IMAGE.                                                                                                                                                        | ANAP              | AUTO      |
| >>Image Box Small Scroll Amount                                                                                                              | (0072,0314) | US | For TILED only, value is 1.                                                                                                                                                            | ANAP              | AUTO      |
| >>Image Box Large Scroll Type                                                                                                                | (0072,0316) | CS | For TILED only, value is ROW_COLUMN.                                                                                                                                                   | ANAP              | AUTO      |
| >>Image Box Large Scroll Amount                                                                                                              | (0072,0318) | US | For TILED only, value is 1.                                                                                                                                                            | ANAP              | AUTO      |
| >Filter Operations Sequence                                                                                                                  | (0072,0400) | SQ | Zero or more sequence items.                                                                                                                                                           | VNAP              | AUTO      |
| >>Filter-by Category                                                                                                                         | (0072,0402) | CS | IMAGE_PLANE if present.                                                                                                                                                                | ANAP              | USER/AUTO |
| >>Selector Attribute                                                                                                                         | (0072,0026) | AT | (0008,0008) Image Type, (0018,0010) Contrast/Bolus Agent, (0018,0086) Echo Number, (0018,5101) View Position, (0054,0220) View Code Sequence, (0054,0222) View Modifier Code Sequence. | ANAP              | USER/AUTO |
| >>Selector Sequence Pointer                                                                                                                  | (0072,0052) | AT | Relevant Sequence Attribute Tags from DICOM Data Dictionary, if Selector Attribute is nested in a Sequence, such as (0054,0220) View Code Sequence.                                    | ANAP              | AUTO      |
| >>Selector Attribute VR                                                                                                                      | (0072,0050) | CS | VR of Selector Attribute, if present                                                                                                                                                   | ANAP              | AUTO      |
| >>The attribute from the Hanging Protocol Selector Attribute Value Macro that is required by the value of Selector Attribute VR, if present. |             |    |                                                                                                                                                                                        | ANAP              | AUTO      |
| >>Selector Value Number                                                                                                                      | (0072,0028) | US | 3 for (0008,0008) Image Type, 1 for other Selector Attributes.                                                                                                                         | ANAP              | AUTO      |
| >>Filter-by Operator                                                                                                                         | (0072,0406) | CS | MEMBER_OF or NOT_MEMBER_OF.                                                                                                                                                            | ALWAYS            | USER      |
| >Sorting Operations Sequence                                                                                                                 | (0072,0600) | SQ | Zero or more sequence items.                                                                                                                                                           | VNAP              | AUTO      |

| Attribute Name                    | Tag         | VR | Value                                                                                                       | Presence of Value | Source    |
|-----------------------------------|-------------|----|-------------------------------------------------------------------------------------------------------------|-------------------|-----------|
| >>Selector Attribute              | (0072,0026) | AT | (0008,0032) Acquisition Time,<br>(0018,0086) Echo Time,<br>(0020,0013) Instance Number.                     | ANAP              | USER      |
| >>Selector Sequence Pointer       | (0072,0052) | AT | Relevant Sequence Attribute Tags from DICOM Data Dictionary, if Selector Attribute is nested in a Sequence. | ANAP              | AUTO      |
| >>Selector Value Number           | (0072,0028) | US | 1 for most Selector Attributes, if present.                                                                 | ANAP              | AUTO      |
| >>Sort-by Category                | (0072,0602) | CS | ALONG_AXIS                                                                                                  | ANAP              | USER      |
| >>Sorting Direction               | (0072,0604) | CS | INCREASING or DECREASING                                                                                    | ALWAYS            | USER      |
| >Display Set Patient Orientation  | (0072,0700) | CS | From user input or automated algorithm.                                                                     | ANAP              | USER/AUTO |
| >VOI Type                         | (0072,0702) | CS | From user input or automated algorithm.                                                                     | ANAP              | USER/AUTO |
| >Show Image True Size Flag        | (0072,0710) | CS | NO                                                                                                          | ALWAYS            | AUTO      |
| >Show Graphic Annotation Flag     | (0072,0712) | CS | YES                                                                                                         | ALWAYS            | AUTO      |
| >Show Patient Demographics Flag   | (0072,0714) | CS | YES                                                                                                         | ALWAYS            | AUTO      |
| >Show Acquisition Techniques Flag | (0072,0716) | CS | YES                                                                                                         | ALWAYS            | AUTO      |
| Partial Data Display Handling     | (0072,0208) | CS | MAINTAIN_LAYOUT                                                                                             | ALWAYS            | AUTO      |
| Synchronized Scrolling Sequence   | (0072,0210) | SQ | Zero or more sequence items, based on user input or automated algorithm.                                    | ANAP              | USER/AUTO |
| >Display Set Scrolling Group      | (0072,0212) | US | Display Set numbers.                                                                                        | ALWAYS            | AUTO      |
| Navigation Indicator Sequence     | (0072,0214) | SQ | Zero or more sequence items, based on user input.                                                           | ANAP              | USER      |
| >Navigation Display Set           | (0072,0216) | US | Display Set number, user or automated.                                                                      | ANAP              | USER/AUTO |
| >Reference Display Sets           | (0072,0218) | US | Display Set numbers, user or automated.                                                                     | ALWAYS            | USER/AUTO |

### G.8.1.2 Usage of attributes from received IOD's

No SOP Class specific fields for images are required.

The Reformatting Operation Type (0072,0510) attribute with value MPR or SLAB is supported for the MR Image Storage SOP Class only.

### G.8.1.3 Attribute Mapping

Not applicable.

**G.8.1.4 Coerced/Modified fields**

No coercion is performed.

**G.8.2 Data Dictionary of Private Attributes**

No private attributes are defined.

**G.8.3 Coded Terminology and Templates**

The value for Code Meaning will be displayed for all code sequences. No local lexicon is provided to look up alternative code meanings.

**G.8.4 Grayscale Image Consistency**

The high resolution display monitor attached to the product can be calibrated according to the Grayscale Standard Display Function (GSDF).

**G.8.5 Standard Extended/Specialized/Private SOP Classes**

None

**G.8.6 Private Transfer Syntaxes**

None.

## **ANNEX H (informative) DICOM CONFORMANCE STATEMENT MEDICATION-SYSTEM-GATEWAY**

### Disclaimer:

This document is an example DICOM Conformance Statement for a fictional device called EXAMPLE-MEDICATION-SYSTEM-GATEWAY, which is a networked computer system used to provide radiology systems with access to a pharmacy system and a medication administration record system.

As stated in the annex title, this document is truly informative, and not normative. A conformance statement of an actual product might implement additional services and options as appropriate for its specific purpose. In addition, an actual product might implement the services described in a different manner and, for example, with different characteristics and/or sequencing of activities. In other words, this conformance statement example does not intend to standardize a particular manner that a product might implement DICOM functionality.

## H.0 COVER PAGE

Company Name: EXAMPLE-GATEWAY-PRODUCTS.

Product Name: EXAMPLE-MEDICATION-SYSTEM-GATEWAY

Version: 1.0-rev. A.1

Internal document number: 4226-xxx-yyy-zzz rev 1

Date: YYYYMMDD

## H.1 CONFORMANCE STATEMENT OVERVIEW

The EXAMPLE-MEDICATION-SYSTEM-GATEWAY is a networked computer system used to provide radiology systems with access to a pharmacy system and a medication administration record system. It allows imaging modalities systems and departmental information systems to retrieve information about drugs and contrast agents, to verify that administration of a drug or contrast agent to a particular patient is allowed, and to record the administration of a drug or contrast agent to a patient.

**Table H.1-1  
NETWORK SERVICES**

| <b>SOP Classes</b>               | <b>User of Service (SCU)</b> | <b>Provider of Service (SCP)</b> |
|----------------------------------|------------------------------|----------------------------------|
| <b>Workflow Management</b>       |                              |                                  |
| Substance Administration Logging | No                           | Yes                              |
| <b>Query/Retrieve</b>            |                              |                                  |
| Product Characteristics Query    | No                           | Yes                              |
| Substance Approval Query         | No                           | Yes                              |

## H.2 TABLE OF CONTENTS

A table of contents shall be provided to assist readers in easily finding the needed information.

## H.3 INTRODUCTION

### H.3.1 REVISION HISTORY

| Document Version | Date             | Author    | Description            |
|------------------|------------------|-----------|------------------------|
| 1.1              | October 30, 2006 | DICOM WG6 | Version for Final Text |
| 1.2              | August 30, 2007  | WG 6      | Revised Introduction   |

### H.3.2 AUDIENCE, REMARKS, TERMS AND DEFINITIONS, BASICS OF DICOM COMMUNICATION, ABBREVIATIONS, REFERENCES

*See example text in Annex A.3.*

### H.3.3 ADDITIONAL REMARKS FOR THIS EXAMPLE

The EXAMPLE-MEDICATION-SYSTEM-GATEWAY relies on the associated, but independent, Pharmacy and Medication Administration Record Systems to fulfill the medical application functions implicit in the DICOM services supported. In particular, these functions are part of a critical patient safety workflow. However, those patient safety functions are not specified by DICOM, and they are not fully described by this Conformance Statement. Please see the product specifications of the Pharmacy and Medication Administration Record Systems for full details on the clinical decision support and records management features of those systems.

This document is a sample DICOM Conformance Statement created for DICOM PS3.2. It is to be used solely as an example to illustrate how to create a DICOM Conformance Statement for a server supporting the DICOM Substance Administration Information Services. The subject of the document, EXAMPLE-MEDICATION-SYSTEM-GATEWAY, is a fictional product.

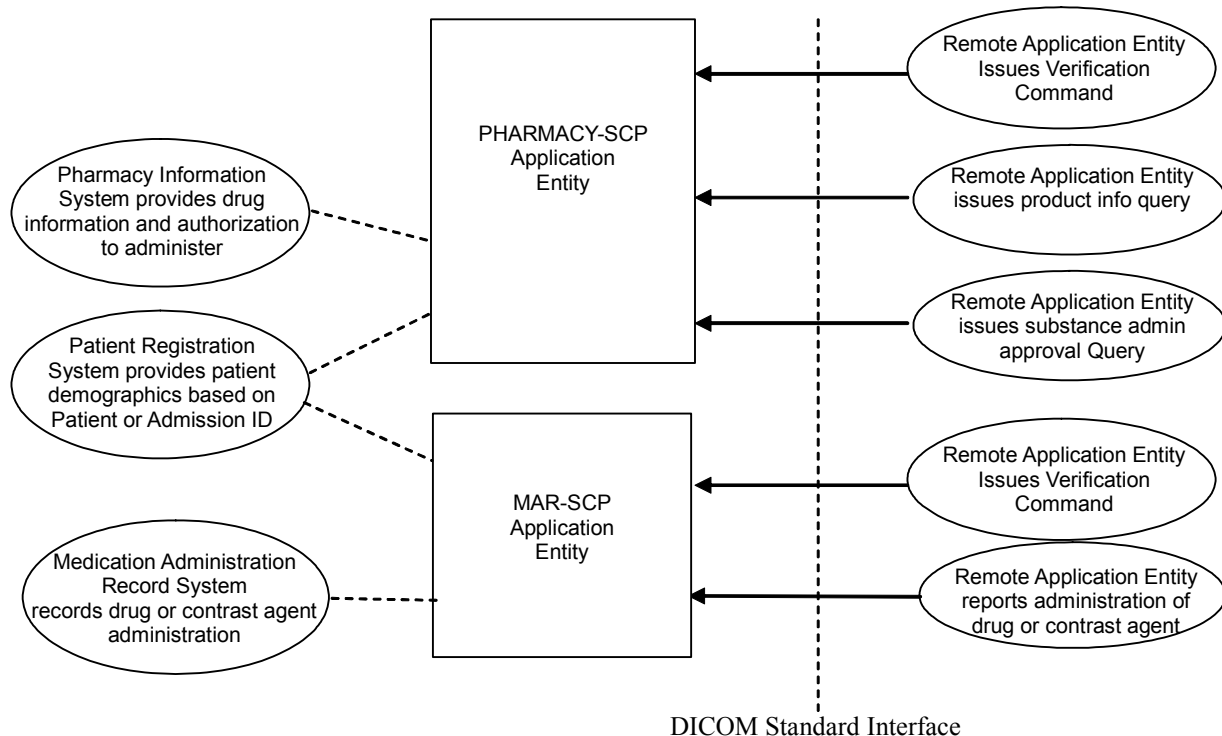
## H.4 NETWORKING

### H.4.1 IMPLEMENTATION MODEL

#### H.4.1.1 Application Data Flow

The division of EXAMPLE-MEDICATION-SYSTEM-GATEWAY into the separate DICOM Application Entities represents their independent logical functionality.

By default all of the defined Application Entities have different AE Titles. However, EXAMPLE-MEDICATION-SYSTEM-GATEWAY can be configured so that the PHARMACY-SCP AE and MAR-SCP AE share the same Application Entity Title.



**Figure H.4.2-1**  
**EXAMPLE-MEDICATION-SYSTEM-GATEWAY DICOM DATA FLOW DIAGRAM**

#### H.4.1.2 Functional Definition of AEs

##### H.4.1.2.1 Functional Definition of PHARMACY-SCP Application Entity

The PHARMACY-SCP AE handles incoming external queries for pharmacy (drug and contrast agent) product data, and also handles requests for approval of administration of pharmacy product. The PHARMACY-SCP AE handles queries by translating the standard DICOM queries to the non-standard interface of the Pharmacy Information System and the Patient Registration System.

The PHARMACY-SCP AE waits for another application to connect at the presentation address configured for its Application Entity Title. PHARMACY-SCP AE will accept Associations with Presentation Contexts for SOP Classes of the DICOM Substance Administration Information Service Class, and Verification

Service Class. It will handle query requests on these Presentation Contexts and respond with values corresponding to the information provided by the Pharmacy Information System.

**H.4.1.2.2 Functional Definition of MAR-SCP Application Entity**

The MAR-SCP AE receives incoming DICOM notifications of drug or contrast agent administration, and adds them to the Medication Administration Record System database.

The MAR-SCP AE waits for another application to connect at the presentation address configured for its Application Entity Title. The MAR-SCP AE will accept Associations with Presentation Contexts for SOP Classes of the Substance Administration Logging and Verification SOP Classes. Any drug or contrast agent administration images notifications received on such Presentation Contexts will be added to the Medication Administration Record System database.

**H.4.1.3 Sequencing of Real-World Activities**

There are no sequencing constraints across the EXAMPLE-MEDICATION-SYSTEM-GATEWAY Application Entities. Each query or notification is handled independently.

**H.4.2 AE SPECIFICATIONS**

**H.4.2.1 PHARMACY-SCP Application Entity Specification**

**H.4.2.1.1 SOP Classes**

The PHARMACY-SCP AE provides Standard Conformance to the following DICOM SOP Classes:

**Table H.4.2-1  
SOP CLASSES FOR PHARMACY-SCP AE**

| SOP Class Name                | SOP Class UID          | SCU | SCP |
|-------------------------------|------------------------|-----|-----|
| Verification                  | 1.2.840.10008.1.1      | No  | Yes |
| Product Characteristics Query | 1.2.840.10008.5.1.4.41 | No  | Yes |
| Substance Approval Query      | 1.2.840.10008.5.1.4.42 | No  | Yes |

**H.4.2.1.2 Association Policies**

**H.4.2.1.2.1 General**

The PHARMACY-SCP AE will never initiate Associations; it only accepts Association Requests from external DICOM AEs. The PHARMACY-SCP AE will accept Associations for Verification (C-ECHO) and Query (C-FIND) requests.

The DICOM standard Application Context Name for DICOM is always accepted:

**Table H.4.2-2  
DICOM APPLICATION CONTEXT FOR PHARMACY-SCP AE**

|                          |                       |
|--------------------------|-----------------------|
| Application Context Name | 1.2.840.10008.3.1.1.1 |
|--------------------------|-----------------------|

**H.4.2.1.2.2 Number of Associations**

The PHARMACY-SCP AE can support multiple simultaneous Associations. Each time the PHARMACY-SCP AE receives an Association, a child process will be spawned to process the Verification or Query request. The maximum number of child processes, and thus the maximum number of simultaneous Associations that can be processed, is set by configuration. The default maximum is 10 in total.

**Table H.4.2-3  
NUMBER OF SIMULTANEOUS ASSOCIATIONS AS A SCP FOR PHARMACY-SCP AE**



|                                             |                   |
|---------------------------------------------|-------------------|
| Maximum number of simultaneous Associations | 10 (Configurable) |
|---------------------------------------------|-------------------|

#### H.4.2.1.2.3 Asynchronous Nature

The PHARMACY-SCP AE does not support asynchronous communication (multiple outstanding transactions over a single Association). All Association requests must be completed and acknowledged before a new operation can be initiated.

**Table H.4.2-4  
ASYNCHRONOUS NATURE AS A SCP FOR PHARMACY-SCP AE**

|                                                         |                      |
|---------------------------------------------------------|----------------------|
| Maximum number of outstanding asynchronous transactions | 1 (Not Configurable) |
|---------------------------------------------------------|----------------------|

#### H.4.2.1.2.4 Implementation Identifying Information

The implementation information for the Application Entity is:

**Table H.4.2-5  
DICOM IMPLEMENTATION CLASS AND VERSION FOR PHARMACY-SCP AE**

|                             |                          |
|-----------------------------|--------------------------|
| Implementation Class UID    | 1.840.xxxxxxx.yyy.etc... |
| Implementation Version Name | EX_VERS_01               |

Note that all EXAMPLE-MEDICATION-SYSTEM-GATEWAY AE's use the same Implementation Class UID and Implementation Version Name. This Version Name is updated with each new release of the product software, as the different AE versions are never released independently.

#### H.4.2.1.3 Association Initiation Policy

The PHARMACY-SCP AE does not initiate Associations.

#### H.4.2.1.4 Association Acceptance Policy

##### H.4.2.1.4.1 Activity – Handling Query Requests

##### H.4.2.1.4.1.1 Description and Sequencing of Activity

The PHARMACY-SCP AE accepts Associations only if they have valid Presentation Contexts. If none of the requested Presentation Contexts are accepted then the Association Request itself is rejected. It can be configured to only accept Associations with certain hosts (using TCP/IP address) and/or Application Entity Titles.

The following sequencing applies to the PHARMACY-SCP AE for handling queries (C-FIND-Requests):

1. Peer AE opens an Association with the PHARMACY-SCP AE.
2. Peer AE sends a C-FIND-RQ Message
3. If the query is for a Substance Administration Approval, PHARMACY-SCP AE requests basic patient demographic data (e.g., name, sex) from the Patient Registration System
4. PHARMACY-SCP AE translates the query into a request for the Pharmacy Information System (for either Product Information or for Substance Administration Approval), which responds with the requested data (or an indication of no matching data for the query).

5. If matching information is provided, PHARMACY-SCP AE returns a C-FIND-RSP Message to the peer AE with the matching information.
6. A final C-FIND-RSP is sent indicating that the matching is complete.
7. Peer AE closes the Association. Note that the peer AE does not have to close the Association immediately. Further C-FIND Requests can be sent over the Association before it is closed.

The PHARMACY-SCP AE may reject Association attempts as shown in the table below. The Result, Source and Reason/Diag columns represent the values returned in the corresponding fields of an ASSOCIATE-RJ PDU (see PS 3.8, Section 9.3.4). The following abbreviations are used in the Source column:

- d. 1 – DICOM UL service-user
- e. 2 – DICOM UL service-provider (ASCE related function)
- f. 3 – DICOM UL service-provider (Presentation related function)

**Table H.4.2-6  
ASSOCIATION REJECTION REASONS**

| <b>Result</b>          | <b>Source</b> | <b>Reason/Diag</b>                         | <b>Explanation</b>                                                                                                                                                                                                                                                                                                                                                   |
|------------------------|---------------|--------------------------------------------|----------------------------------------------------------------------------------------------------------------------------------------------------------------------------------------------------------------------------------------------------------------------------------------------------------------------------------------------------------------------|
| 2 – rejected-transient | c             | 2 – local-limit-exceeded                   | The (configurable) maximum number of simultaneous Associations has been reached. An Association request with the same parameters may succeed at a later time.                                                                                                                                                                                                        |
| 2 – rejected-transient | c             | 1 – temporary-congestion                   | No Associations can be accepted at this time due to the real-time requirements of higher priority activities or because insufficient resources are available (e.g. memory, processes, threads). An Association request with the same parameters may succeed at a later time.                                                                                         |
| 1 – rejected-permanent | a             | 2 – application-context-name-not-supported | The Association request contained an unsupported Application Context Name. An association request with the same parameters will not succeed at a later time.                                                                                                                                                                                                         |
| 1 – rejected-permanent | a             | 7 – called-AE-title-not-recognized         | The Association request contained an unrecognized Called AE Title. An Association request with the same parameters will not succeed at a later time unless configuration changes are made. This rejection reason normally occurs when the Association initiator is incorrectly configured and attempts to address the Association acceptor using the wrong AE Title. |
| 1 – rejected-permanent | a             | 3 – calling-AE-title-not-recognized        | The Association request contained an unrecognized Calling AE Title. An Association request with the same parameters will not succeed at a later time unless configuration changes are made. This rejection reason normally occurs when the Association acceptor has not been configured to recognize the AE Title of the Association initiator.                      |
| 1 – rejected-permanent | b             | 1 – no-reason-given                        | The Association request could not be parsed. An Association request with the same format will not succeed at a later time.                                                                                                                                                                                                                                           |

The PHARMACY-SCP AE will close the Association under the exceptional circumstances listed in Table H.4.2-7.

**Table H.4.2-7  
PHARMACY-SCP AE COMMUNICATION FAILURE BEHAVIOR**

| Exception                                                                                                                                                                                 | Behavior                                                                                                      |
|-------------------------------------------------------------------------------------------------------------------------------------------------------------------------------------------|---------------------------------------------------------------------------------------------------------------|
| Timeout expiry for an expected DICOM Message Request (DIMSE level timeout). I.e. The PHARMACY-SCP AE is waiting for the next C-FIND Request on an open Association but the timer expires. | The Association is aborted by issuing a DICOM A-ABORT.<br>Error message is output to the Service Audit Trail. |
| Timeout expiry for an expected DICOM PDU or TCP/IP packet (Low-level timeout). I.e. The PHARMACY-SCP AE is waiting for the next message PDU but the timer expires.                        | The Association is aborted by issuing a DICOM A-ABORT.<br>Error message is output to the Service Audit Trail. |
| Association aborted by the SCU or the network layers indicate communication loss (i.e. low-level TCP/IP socket closure)                                                                   | Error message is output to the Service Audit Trail.                                                           |

#### H.4.2.1.4.1.2 Accepted Presentation Contexts

The PHARMACY-SCP AE will accept Presentation Contexts as shown in Table H.4.2-8.

**Table H.4.2-8  
ACCEPTED PRESENTATION CONTEXTS BY THE PHARMACY-SCP AE**

| Presentation Context Table    |                        |                                 |                     |      |           |
|-------------------------------|------------------------|---------------------------------|---------------------|------|-----------|
| Abstract Syntax               |                        | Transfer Syntax                 |                     | Role | Ext. Neg. |
| Name                          | UID                    | Name                            | UID                 |      |           |
| Verification                  | 1.2.840.10008.1.1      | DICOM Implicit VR Little Endian | 1.2.840.10008.1.2   | SCP  | None      |
| Product Characteristics Query | 1.2.840.10008.5.1.4.41 | DICOM Implicit VR Little Endian | 1.2.840.10008.1.2   | SCP  | None      |
|                               |                        | DICOM Explicit VR Little Endian | 1.2.840.10008.1.2.1 |      |           |
| Substance Approval Query      | 1.2.840.10008.5.1.4.42 | DICOM Implicit VR Little Endian | 1.2.840.10008.1.2   | SCP  | None      |
|                               |                        | DICOM Explicit VR Little Endian | 1.2.840.10008.1.2.1 |      |           |

#### H.4.2.2.4.1.3 SOP Specific Conformance for Verification SOP Class

The PHARMACY -SCP AE provides standard conformance to the Verification SOP Class as an SCP.

#### H.4.2.1.4.1.4 SOP Specific Conformance for Product Characteristics Query SOP Class

The PHARMACY-SCP AE supports the Return Key Attributes shown in Tables H.4.2-9 and H.4.2-10. Only those attributes requested in the query identifier are returned. Note that queries about devices are not supported.

**Table H.4.2-9  
RETURN KEY ATTRIBUTES SUPPORTED FOR PRODUCT CHARACTERISTICS QUERY**

|                            |             |                                 |
|----------------------------|-------------|---------------------------------|
| Product Package Identifier | (0044,0001) | Returned with query match value |
| Product Type Code Sequence | (0044,0007) | RxNorm coded type of drug       |
| Manufacturer               | (0008,0070) |                                 |
| Product Name               | (0044,0008) |                                 |
| Product Description        | (0044,0009) |                                 |
| Product Lot Identifier     | (0044,000A) |                                 |

|                              |             |                                             |
|------------------------------|-------------|---------------------------------------------|
| Product Expiration DateTime  | (0044,000B) |                                             |
| Product Parameter Sequence   | (0044,0013) | See Table H.4.2-10 for parameters supported |
| Pertinent Documents Sequence | (0038,0100) | Zero or one item returned                   |
| >Retrieve URI                | (0040,E010) |                                             |

**Table H.4.2-10  
PRODUCT PARAMETER SEQUENCE ITEM CONCEPTS SUPPORTED**

| <b>Concept Name Code Sequence<br/>(0040,A043)</b> |
|---------------------------------------------------|
| (G-D705, SRT, "Volume")                           |
| (G-C52F, SRT, "Active Ingredient")                |

Only the ASCII (DICOM Default) character set is supported by the Pharmacy Information System; Specific Character Set (0008,0005) is not used.

**H.4.2.1.4.1.5 SOP Specific Conformance for Substance Approval Query SOP Class**

The PHARMACY-SCP AE supports the Matching Key Attributes shown in Table H.4.2-11. It can be configured to match on Patient ID, or on Admission ID, or on a combination of Patient ID and Issuer of Patient ID, or on a combination of Admission ID and Issuer of Admission ID. As required by the SOP Class, one of Patient ID or Admission ID must be present in the query, as must Product Package Identifier and Administration Route Code Sequence. Note, however, that the Pharmacy Information System does not support verification of administration route. Also note that queries about devices are not supported.

**Table H.4.2-11  
MATCHING KEY ATTRIBUTES SUPPORTED FOR SUBSTANCE APPROVAL QUERY**

|                                    |             |
|------------------------------------|-------------|
| Patient ID                         | (0010,0020) |
| Issuer of Patient ID               | (0010,0021) |
| Admission ID                       | (0038,0010) |
| Issuer of Admission ID             | (0038,0011) |
| Product Package Identifier         | (0044,0001) |
| Administration Route Code Sequence | (0054,0302) |
| >Code Value                        | (0008,0100) |
| >Coding Scheme Designator          | (0008,0102) |

The PHARMACY-SCP AE supports the Return Key Attributes shown in Table H.4.2-12. Only those attributes requested in the query identifier are returned.

**Table H.4.2-12  
RETURN KEY ATTRIBUTES SUPPORTED FOR SUBSTANCE APPROVAL QUERY**

|                                     |             |                                                                                                                                         |
|-------------------------------------|-------------|-----------------------------------------------------------------------------------------------------------------------------------------|
| Patient's Name                      | (0010,0010) | Obtained from Patient Registration System                                                                                               |
| Patient ID                          | (0010,0020) | Obtained from Patient Registration System if AE configured for Admission ID matching, or Admission ID + Issuer of Admission ID matching |
| Issuer of Patient ID                | (0010,0021) | Returned only if AE configured for Patient ID + Issuer of Patient ID matching                                                           |
| Patient's Birth Date                | (0010,0030) | Obtained from Patient Registration System                                                                                               |
| Patient's Sex                       | (0010,0040) | Obtained from Patient Registration System                                                                                               |
| Admission ID                        | (0038,0010) | Returned only if AE configured for Admission ID matching, or Admission ID + Issuer of Admission ID matching                             |
| Issuer of Admission ID              | (0038,0011) | Returned only if AE configured for Admission ID + Issuer of Admission ID matching                                                       |
| Product Package Identifier          | (0044,0001) | Returned with query match value                                                                                                         |
| Administration Route Code Sequence  | (0054,0302) | Returned with query match value                                                                                                         |
| Substance Administration Approval   | (0044,0002) | Obtained from Pharmacy Information System                                                                                               |
| Approval Status Further Description | (0044,0003) | Obtained from Pharmacy Information System                                                                                               |
| Approval Status DateTime            | (0044,0004) |                                                                                                                                         |

Specific Character Set (0008,0005) is returned with value ISO\_IR 192 if the Patient Registration System provides non-ASCII Unicode characters in Patient Name.

**H.4.2.1.4.1.6 Pharmacy-SCP AE C-FIND Response Behavior**

The PHARMACY-SCP AE supports the C-FIND Response Status return values and behavior shown in Table H.4.2-13.

**Table H.4.2-13  
PHARMACY-SCP AE C-FIND RESPONSE STATUS RETURN BEHAVIOR**

| Service Status | Further Meaning  | Error Code | Behavior                                                                                                                                                                |
|----------------|------------------|------------|-------------------------------------------------------------------------------------------------------------------------------------------------------------------------|
| Success        | Success          | 0000       | Matching is complete. No final identifier is supplied.                                                                                                                  |
| Failure        | Out of Resources | A700       | System reached the limit in memory usage for queuing requests to the Pharmacy Information System.<br>Error message is output to as an alert to the Service Audit Trail. |

|         |                                                                          |      |                                                                                                                                                                                                       |
|---------|--------------------------------------------------------------------------|------|-------------------------------------------------------------------------------------------------------------------------------------------------------------------------------------------------------|
|         | Identifier does not match SOP Class                                      | A900 | The C-FIND query identifier contains invalid Elements or values, or is missing mandatory Elements or values for the specified SOP Class.<br>Error message is output to the Service Audit Trail.       |
|         | Unable to process                                                        | C001 | The AE is unable to establish a session with the Pharmacy Information System.<br>Error message is output to the Service Audit Trail.                                                                  |
|         | Unable to process                                                        | C002 | The AE is unable to establish a session with the Patient Registration System.<br>Error message is output to the Service Audit Trail.                                                                  |
|         | Unable to process                                                        | C110 | The AE is unable to identify the Patient.<br>Error message is output to the Service Audit Trail.                                                                                                      |
|         | Unable to process                                                        | C120 | The AE is unable to identify the Product.<br>Error message is output to the Service Audit Trail.                                                                                                      |
| Cancel  | Matching terminated due to Cancel Request                                | FE00 | The C-FIND SCU sent a Cancel Request. This has been acknowledged and the search for matches has been halted.                                                                                          |
| Pending | Matches are continuing and current match is supplied.                    | FF00 | Indicates that the successful match is returned and a further response (0000) is forthcoming. This status code is returned if all Optional keys in the query identifier are actually supported.       |
|         | Matches are continuing but one or more Optional Keys were not supported. | FF01 | Indicates that the successful match is returned and a further response (0000) is forthcoming. This status code is returned if there are Optional keys in the query identifier that are not supported. |

#### H.4.2.2 MAR-SCP Application Entity Specification

##### H.4.2.2.1 SOP Classes

The MAR-SCP AE provides Standard Conformance to the following DICOM SOP Classes:

**Table H.4.2-14**  
**SOP CLASSES FOR MAR-SCP AE**

| SOP Class Name                   | SOP Class UID      | SCU | SCP |
|----------------------------------|--------------------|-----|-----|
| Verification                     | 1.2.840.10008.1.1  | No  | Yes |
| Substance Administration Logging | 1.2.840.10008.1.42 | No  | Yes |

##### H.4.2.2.2 Association Policies

###### H.4.2.2.2.1 General

The MAR-SCP AE will never initiate Associations; it only accepts Association Requests from external DICOM AEs. The MAR-SCP AE will accept Associations for Verification (C-ECHO) and Substance Administration Logging (N-ACTION) requests.

The DICOM standard Application Context Name for DICOM 3.0 is always accepted and proposed:

**Table H.4.2-15  
DICOM APPLICATION CONTEXT FOR MAR-SCP AE**

|                          |                       |
|--------------------------|-----------------------|
| Application Context Name | 1.2.840.10008.3.1.1.1 |
|--------------------------|-----------------------|

**H.4.2.2.2.2 Number of Associations**

The MAR-SCP AE can support multiple simultaneous Associations. Each time the MAR-SCP AE receives an Association, a child process will be spawned to process the Verification or Substance Administration Logging request. The maximum number of child processes, and thus the maximum number of simultaneous Associations that can be processed, is set by configuration. The default maximum number is 10 in total.

**Table H.4.2-16  
NUMBER OF SIMULTANEOUS ASSOCIATIONS AS AN SCP FOR MAR-SCP AE**

|                                                                   |                   |
|-------------------------------------------------------------------|-------------------|
| Maximum number of simultaneous Associations requested by peer AEs | 10 (Configurable) |
|-------------------------------------------------------------------|-------------------|

**H.4.2.2.2.3 Asynchronous Nature**

The MAR-SCP AE does not support asynchronous communication (multiple outstanding transactions over a single Association). All Association requests must be completed and acknowledged before a new operation can be initiated.

**Table H.4.2-17  
ASYNCHRONOUS NATURE AS A SCP FOR MAR-SCP AE**

|                                                         |                      |
|---------------------------------------------------------|----------------------|
| Maximum number of outstanding asynchronous transactions | 1 (Not Configurable) |
|---------------------------------------------------------|----------------------|

**H.4.2.2.2.4 Implementation Identifying Information**

The implementation information for this Application Entity is:

**Table H.4.2-18  
DICOM IMPLEMENTATION CLASS AND VERSION FOR MAR-SCP AE**

|                             |                          |
|-----------------------------|--------------------------|
| Implementation Class UID    | 1.840.xxxxxxx.yyy.etc... |
| Implementation Version Name | EX_VERS_01               |

Note that all EXAMPLE-MEDICATION-SYSTEM-GATEWAY AE's use the same Implementation Class UID and Implementation Version Name. This Version Name is updated with each new release of the product software, as the different AE versions are never released independently.

**H.4.2.2.3 Association Initiation Policy**

The MAR-SCP AE does not initiate Associations.

**H.4.2.2.4 Association Acceptance Policy**

**H.4.2.2.4.1 Activity – Handling Substance Administration Logging Requests**

**H.4.2.2.4.1.1 Description and Sequencing of Activity**

The MAR-SCP AE accepts Associations only if they have valid Presentation Contexts. If none of the requested Presentation Contexts are accepted then the Association Request itself is rejected. It can be

configured to only accept Associations with certain hosts (using TCP/IP address) and/or Application Entity Titles.

The following sequencing applies to the MAR-SCP AE for handling Substance Administration Logging Requests (N-ACTION):

1. Peer AE opens an Association with the MAR-SCP AE.
2. Peer AE sends N-ACTION-RQ to request logging of a substance administration event.
3. If the request does not include the Patient ID, MAR-SCP AE requests the Patient ID corresponding to the Admission ID from the Patient Registration System
4. MAR-SCP AE translates the logging request into a database operation on the Medication Administration Record System database.
5. MAR-SCP AE responds with N-ACTION-RSP to indicate that it received and processed the request.
6. Peer AE closes the Association. Note that the peer AE does not have to close the Association immediately. Further N-ACTION Requests can be sent over the Association before it is closed.

The MAR-SCP AE may reject Association attempts as shown in the Table below. The Result, Source and Reason/Diag columns represent the values returned in the corresponding fields of an ASSOCIATE-RJ PDU (see PS 3.8, Section 9.3.4). The following abbreviations are used in the Source column:

- d. 1 – DICOM UL service-user
- e. 2 – DICOM UL service-provider (ASCE related function)
- f. 3 – DICOM UL service-provider (Presentation related function)

**Table H.4.2-19  
ASSOCIATION REJECTION REASONS**

| Result                 | Source | Reason/Diag                                | Explanation                                                                                                                                                                                                                                                                                                                                                          |
|------------------------|--------|--------------------------------------------|----------------------------------------------------------------------------------------------------------------------------------------------------------------------------------------------------------------------------------------------------------------------------------------------------------------------------------------------------------------------|
| 2 – rejected-transient | c      | 2 – local-limit-exceeded                   | The (configurable) maximum number of simultaneous Associations has been reached. An Association request with the same parameters may succeed at a later time.                                                                                                                                                                                                        |
| 2 – rejected-transient | c      | 1 – temporary-congestion                   | No Associations can be accepted at this time due to the real-time requirements of higher priority activities (e.g. during image acquisition no Associations will be accepted) or because insufficient resources are available (e.g. memory, processes, threads). An Association request with the same parameters may succeed at a later time.                        |
| 1 – rejected-permanent | a      | 2 – application-context-name-not-supported | The Association request contained an unsupported Application Context Name. An association request with the same parameters will not succeed at a later time.                                                                                                                                                                                                         |
| 1 – rejected-permanent | a      | 7 – called-AE-title-not-recognized         | The Association request contained an unrecognized Called AE Title. An Association request with the same parameters will not succeed at a later time unless configuration changes are made. This rejection reason normally occurs when the Association initiator is incorrectly configured and attempts to address the Association acceptor using the wrong AE Title. |
| 1 – rejected-          | a      | 3 – calling-AE-title-not-                  | The Association request contained an unrecognized Calling AE Title. An Association request with the same parameters                                                                                                                                                                                                                                                  |



|                        |   |                     |                                                                                                                                                                                                                             |
|------------------------|---|---------------------|-----------------------------------------------------------------------------------------------------------------------------------------------------------------------------------------------------------------------------|
| permanent              |   | recognized          | will not succeed at a later time unless configuration changes are made. This rejection reason normally occurs when the Association acceptor has not been configured to recognize the AE Title of the Association initiator. |
| 1 – rejected-permanent | b | 1 – no-reason-given | The Association request could not be parsed. An Association request with the same format will not succeed at a later time.                                                                                                  |

The MAR-SCP AE will close the Association under the exceptional circumstances listed in Table H.4.2-20.

**Table H.4.2-20  
PHARMACY-SCP AE COMMUNICATION FAILURE BEHAVIOR**

| Exception                                                                                                                                                                              | Behavior                                                                                                      |
|----------------------------------------------------------------------------------------------------------------------------------------------------------------------------------------|---------------------------------------------------------------------------------------------------------------|
| Timeout expiry for an expected DICOM Message Request (DIMSE level timeout). I.e. The MAR-SCP AE is waiting for the next N-ACTION Request on an open Association but the timer expires. | The Association is aborted by issuing a DICOM A-ABORT.<br>Error message is output to the Service Audit Trail. |
| Timeout expiry for an expected DICOM PDU or TCP/IP packet (Low-level timeout). I.e. The MAR-SCP AE is waiting for the next message PDU but the timer expires.                          | The Association is aborted by issuing a DICOM A-ABORT.<br>Error message is output to the Service Audit Trail. |
| Association aborted by the SCU or the network layers indicate communication loss (i.e. low-level TCP/IP socket closure)                                                                | Error message is output to the Service Audit Trail.                                                           |

**H.4.2.2.4.1.2 Accepted Presentation Contexts**

The MAR-SCP AE will accept Presentation Contexts as shown in Table H.4.2-21.

**Table H.4.2-21  
ACCEPTED PRESENTATION CONTEXTS BY MAR-SCP AE**

| Presentation Context Table       |                    |                                 |                     |      |           |
|----------------------------------|--------------------|---------------------------------|---------------------|------|-----------|
| Abstract Syntax                  |                    | Transfer Syntax                 |                     | Role | Ext. Neg. |
| Name                             | UID                | Name                            | UID                 |      |           |
| Verification                     | 1.2.840.10008.1.1  | DICOM Implicit VR Little Endian | 1.2.840.10008.1.2   | SCP  | None      |
| Substance Administration Logging | 1.2.840.10008.1.42 | DICOM Implicit VR Little Endian | 1.2.840.10008.1.2   | SCP  | None      |
|                                  |                    | DICOM Explicit VR Little Endian | 1.2.840.10008.1.2.1 |      |           |

**H.4.2.2.4.1.3 SOP Specific Conformance for Verification SOP Class**

The MAR-SCP AE provides standard conformance to the Verification SOP Class as an SCP.

**H.4.2.2.4.1.4 SOP Specific Conformance for Substance Administration Logging SOP Classes**

As required by the SOP Class, one of Patient ID or Admission ID must be present in the Substance Administration Logging request. If the request does not include the Patient ID, the MAR-SCP AE requests the Patient ID corresponding to the Admission ID from the Patient Registration System.

The MAR-SCP AE SCP translates the attributes shown in Table H.4.2-22 into database fields of the Medication Administration Record System. All other provided attributes are converted to text strings and placed in the ClinicalNotes field of the database.

**Table H.4.2-22**  
**ATTRIBUTES OF LOGGING REQUEST IMPORTED TO MAR DATABASE**

|                                    |             |
|------------------------------------|-------------|
| Patient ID                         | (0010,0020) |
| Product Package Identifier         | (0044,0001) |
| Product Name                       | (0044,0008) |
| Substance Administration DateTime  | (0044,0010) |
| Administration Route Code Sequence | (0054,0302) |
| Operator Identification Sequence   | (0008,1072) |

The MAR-SCP AE supports the N-ACTION Response Status return values and behavior shown in Table H.4.2-23.

**Table H.4.2-23**  
**MAR-SCP AE N-ACTION RESPONSE STATUS RETURN REASONS**

| Service Status | Further Meaning                                                          | Status Code | Reason                                                                                                                                                                                                                    |
|----------------|--------------------------------------------------------------------------|-------------|---------------------------------------------------------------------------------------------------------------------------------------------------------------------------------------------------------------------------|
| Success        | Success                                                                  | 0000        | The log entry was successfully received and stored in the Medication Administration Record System database.                                                                                                               |
| Failure        | Processing failure                                                       | 0110        | The AE is unable to establish a session with the Medication Administration Record System (Error ID=C003), or with the Patient Registration System (Error ID=C002).<br>Error message is output to the Service Audit Trail. |
|                | Operator not authorized to add entry to Medication Administration Record | C10E        | The AE received a user authorization rejection from the Medication Administration Record System.<br>Error message is output to the Service Audit Trail.                                                                   |
|                | Patient cannot be identified from Patient ID or Admission ID             | C110        | The AE is unable to identify the Patient.<br>Error message is output to the Service Audit Trail.                                                                                                                          |
|                | Update of Medication Administration Record failed                        | C111        | The Medication Administration Record System reported a database error.<br>Error message is output to the Service Audit Trail.                                                                                             |

### H.4.3 NETWORK INTERFACES

#### H.4.3.1 Physical Network Interface

The EXAMPLE-MEDICATION-SYSTEM-GATEWAY supports a single network interface. One of the following physical network interfaces will be available depending on installed hardware options:

**Table H.4.3-1**  
**SUPPORTED PHYSICAL NETWORK INTERFACES**

- Standard -

|                   |
|-------------------|
| Ethernet 100baseT |
| Gigabit Ethernet  |

#### H.4.3.2 Additional Protocols

EXAMPLE-MEDICATION-SYSTEM-GATEWAY conforms to the System Management Profiles listed in Table F.4.3-2. All requested transactions for the listed profiles and actors are supported. It does not support any optional transactions.

**Table H.4.3-2  
SUPPORTED SYSTEM MANAGEMENT PROFILES**

| Profile Name               | Actor       | Protocols Used | Optional Transactions | Security Support |
|----------------------------|-------------|----------------|-----------------------|------------------|
| Network Address Management | DHCP Client | DHCP           | N/A                   |                  |
|                            | DNS Client  | DNS            | N/A                   |                  |

#### H.4.3.2.1 DHCP

DHCP can be used to obtain TCP/IP network configuration information. The network parameters obtainable via DHCP are shown in Table F.4.3-3. The Default Value column of the table shows the default used if the DHCP server does not provide a value. Values for network parameters set in the Service/Installation tool take precedence over values obtained from the DHCP server. Support for DHCP can be configured via the Service/Installation Tool. The Service/Installation tool can be used to configure the machine name. If DHCP is not in use, TCP/IP network configuration information can be manually configured via the Service/Installation Tool.

**Table H.4.3-3  
SUPPORTED DHCP PARAMETERS**

| DHCP Parameter      | Default Value                                |
|---------------------|----------------------------------------------|
| IP Address          | None                                         |
| Hostname            | Requested machine name                       |
| List of NTP servers | Empty list                                   |
| List of DNS servers | Empty list                                   |
| Routers             | Empty list                                   |
| Static routes       | None                                         |
| Domain name         | None                                         |
| Subnet mask         | Derived from IP Address (see service manual) |
| Broadcast address   | Derived from IP Address (see service manual) |
| Default router      | None                                         |
| Time offset         | Site configurable (from Time zone)           |
| MTU                 | Network Hardware Dependent                   |
| Auto-IP permission  | No permission                                |

If the DHCP server refuses to renew a lease on the assigned IP address all active DICOM Associations will be aborted.

### H.4.3.2.2 DNS

DNS can be used for address resolution. If DHCP is not in use or the DHCP server does not return any DNS server addresses, the identity of a DNS server can be configured via the Service/Installation Tool. If a DNS server is not in use, local mapping between hostname and IP address can be manually configured via the Service/Installation Tool.

## H.4.4 CONFIGURATION

### H.4.4.1 AE Title/Presentation Address Mapping

#### H.4.4.1.1 Local AE Titles

The mapping from AE Title to TCP/IP addresses and ports is configurable and set at the time of installation by Installation Personnel.

**Table H.4.4-1  
DEFAULT APPLICATION ENTITY CHARACTERISTICS**

| Application Entity | Role | Default AE Title | Default TCP/IP Port |
|--------------------|------|------------------|---------------------|
| PHARMACY-SCP       | SCP  | EX_PHAR_SCP      | 5000                |
| MAR-SCP            | SCP  | EX_MAR_SCP       | 4000                |

The PHARMACY-SCP and MAR-SCP Application Entities can be configured to have the same AE Title.

#### H.4.4.1.2 Remote AE Title/Presentation Address Mapping

The mapping of external AE Titles to TCP/IP addresses and ports is configurable and set at the time of installation by Installation Personnel. This mapping is necessary for resolving the IP address and port of C-MOVE Destination Application Entities and must be correctly configured for the PHARMACY-SCP AE to correctly function as a C-MOVE SCP.

### H.4.4.2 Parameters

**Table H.4.4-2  
CONFIGURATION PARAMETERS**

| Parameter                                                                                                         | Configurable | Default Value |
|-------------------------------------------------------------------------------------------------------------------|--------------|---------------|
| <b>General Parameters</b>                                                                                         |              |               |
| Maximum PDU size I can receive                                                                                    | Yes          | 128kbytes     |
| Maximum PDU size I can send                                                                                       | Yes          | 128kbytes     |
| Time-out waiting for response to TCP/IP connect() request. (Low-level timeout)                                    | Yes          | 10 s          |
| Time-out waiting for A-ASSOCIATE RQ PDU on open TCP/IP connection. (ARTIM timeout)                                | Yes          | 30 s          |
| Time-out waiting for acceptance or rejection response to an Association Open Request. (Application Level timeout) | Yes          | 30s           |
| Time-out waiting for acceptance of a TCP/IP message over the network. (Low-level timeout)                         | Yes          | 30 s          |
| Time-out for waiting for data between TCP/IP packets. (Low-level timeout)                                         | Yes          | 30 s          |
| <b>PHARMACY-SCP AE Parameters</b>                                                                                 |              |               |
| Maximum number of simultaneous Associations                                                                       | Yes          | 10            |
| AE time-out waiting on an open Association for the next message (C-FIND-RQ, Association Close Request. etc.)      | Yes          | 1 minute      |

|                                                                                                                                        |     |          |
|----------------------------------------------------------------------------------------------------------------------------------------|-----|----------|
| (DIMSE timeout)                                                                                                                        |     |          |
| <b>MAR-SCP AE Parameters</b>                                                                                                           |     |          |
| Maximum number of simultaneous Associations                                                                                            | Yes | 10       |
| AE time-out waiting on an open Association for the next Request message (N-ACTION-RQ, Association Close Request. etc.) (DIMSE timeout) | Yes | 1 minute |

## **H.5 MEDIA INTERCHANGE**

EXAMPLE-MEDICATION-SYSTEM-GATEWAY does not support Media Storage.

## **H.6 SUPPORT OF EXTENDED CHARACTER SETS**

All EXAMPLE-MEDICATION-SYSTEM-GATEWAY DICOM applications support the following:

ISO\_IR 192 (Unicode)

## **H.7 SECURITY**

### **H.7.1 SECURITY PROFILES**

The EXAMPLE-MEDICATION-SYSTEM-GATEWAY is configurable to support the Kerberos Identity Negotiation Association Profile.

### **H.7.2 ASSOCIATION LEVEL SECURITY**

The PHARMACY-SCP AE and the MAR-SCP AE can both be configured to accept Association Requests from only a limited list of Calling AE Titles. The SCP AEs can have different lists. Each SCP AE can be configured to check that the Association requestor specifies the correct Called AE Title for the SCP.

In addition the IP address of the requestor can be checked. The SCP AEs can be constrained to only accept Association Requests from a configured list of IP addresses. The SCP AE's can have different lists.