

DOMAIN System User's Guide

Order No. 005488
Revision 02

Apollo Computer Inc.
330 Billerica Road
Chelmsford, MA 01824

Copyright © 1987 Apollo Computer Inc.
All rights reserved. Printed in U.S.A.

First Printing: July, 1985
Latest Printing: January, 1987

This document was produced using the Interleaf Workstation Publishing Software (WPS). Interleaf and WPS are trademarks of Interleaf, Inc.

APOLLO and DOMAIN are registered trademarks of Apollo Computer Inc.

AEGIS, DGR, DOMAIN/BRIDGE, DOMAIN/DFL-100, DOMAIN/DQC-100, DOMAIN/Dialogue, DOMAIN/IX, DOMAIN/Laser-26, DOMAIN/PCI, DOMAIN/SNA, D3M, DPSS, OSEE, GMR, and GPR are trademarks of Apollo Computer Inc.

Apollo Computer Inc. reserves the right to make changes in specifications and other information contained in this publication without prior notice, and the reader should in all cases consult Apollo Computer Inc. to determine whether any such changes have been made.

THE TERMS AND CONDITIONS GOVERNING THE SALE OF APOLLO COMPUTER INC. HARDWARE PRODUCTS AND THE LICENSING OF APOLLO COMPUTER INC. SOFTWARE CONSIST SOLELY OF THOSE SET FORTH IN THE WRITTEN CONTRACTS BETWEEN APOLLO COMPUTER INC. AND ITS CUSTOMERS. NO REPRESENTATION OR OTHER AFFIRMATION OF FACT CONTAINED IN THIS PUBLICATION, INCLUDING BUT NOT LIMITED TO STATEMENTS REGARDING CAPACITY, RESPONSE-TIME PERFORMANCE, SUITABILITY FOR USE OR PERFORMANCE OF PRODUCTS DESCRIBED HEREIN SHALL BE DEEMED TO BE A WARRANTY BY APOLLO COMPUTER INC. FOR ANY PURPOSE, OR GIVE RISE TO ANY LIABILITY BY APOLLO COMPUTER INC. WHATSOEVER.

IN NO EVENT SHALL APOLLO COMPUTER INC. BE LIABLE FOR ANY INCIDENTAL, INDIRECT, SPECIAL OR CONSEQUENTIAL DAMAGES WHATSOEVER (INCLUDING BUT NOT LIMITED TO LOST PROFITS) ARISING OUT OF OR RELATING TO THIS PUBLICATION OR THE INFORMATION CONTAINED IN IT, EVEN IF APOLLO COMPUTER INC. HAS BEEN ADVISED, KNEW OR SHOULD HAVE KNOWN OF THE POSSIBILITY OF SUCH DAMAGES.

THE SOFTWARE PROGRAMS DESCRIBED IN THIS DOCUMENT ARE CONFIDENTIAL INFORMATION AND PROPRIETARY PRODUCTS OF APOLLO COMPUTER INC. OR ITS LICENSORS.

PREFACE

The *DOMAIN[®] System User's Guide* is the second volume in the two-volume introduction to the *DOMAIN[®]* (Distributed On-line Multi-Access Interactive Network) Computing System. The first volume, *Getting Started With Your DOMAIN System*, introduces you to the basic concepts you'll need to use the *DOMAIN* system on your node. The *DOMAIN System User's Guide* follows with more detailed information about the system and describes how to use the system to perform various computing tasks.

The Organization of this Manual

We've divided this manual into three separate parts, each part describing a set of related topics. Part I describes the *DOMAIN* system. Part II and Part III describe how to perform various tasks using system commands and utilities. We've separated each part with a tabbed divider for easy access.

Part I -- The DOMAIN System

- | | |
|------------------|---|
| Chapter 1 | Provides an overview of the <i>DOMAIN</i> system and its distributed operating environment. It describes how the system organizes objects in the system naming tree, and how to use pathnames to identify these objects. |
| Chapter 2 | Describes how the system functions at startup and log-in, and describes how to create, modify, and organize the various scripts that set up your node's particular operating environment. The chapter also describes procedures for changing your password and log-in home directory when you log in. |

Part II -- The Display Environment

- Chapter 3** Explains the functions of the Display Manager (DM), describes how to use DM commands, and shows how to define keys to perform DM functions.
- Chapter 4** Describes how to use the DM to control your node's display. Each section describes a set of related display management tasks and the DM commands you use to perform them.
- Chapter 5** Describes how to use the DM to control the characteristics of edit pads and how to edit text. Each section in this chapter describes a set of editing tasks and the DM commands you use to perform them.

Part III -- The Command Shell

- Chapter 6** Describes the command Shell environment that processes Shell commands. The chapter includes information on: Shell commands, controlling command input and output, the command line parser, and using pathname wildcards.
- Chapter 7** Describes how to use Shell commands to manage files, directories, and links on the system.
- Chapter 8** Describes Access Control Lists (ACLs) and how to use them to control access to files and directories.
- Chapter 9** Describes how to write Shell scripts using Shell commands, operators, and expressions.

Documentation Conventions

Unless otherwise noted in the text, this manual uses the following symbolic conventions.

UPPERCASE	Bold, uppercase words or characters in formats and command descriptions represent commands or keywords that you must use literally.
lowercase	Bold, lowercase words or characters in formats and command descriptions represent values that you must supply.
example	Color words in command examples represent literal user keyboard input.
output	System output in command examples appears in this font.
Bolded term or key	When new terms or keys are introduced, they appear in boldface .
[]	Square brackets enclose optional items in formats and command descriptions. In sample Pascal statements, square brackets assume their Pascal meanings.
{ }	Braces enclose a list from which you must choose an item in formats and command descriptions. In sample Pascal statements, braces assume their Pascal meanings.
	A vertical bar separates items in a list of choices.
< >	Angle brackets enclose the name of a key on the keyboard.

- CTRL/ The notation CTRL/ followed by the name of a key indicates a control character sequence. You should hold down <CTRL> while typing the character.

- . . . Horizontal ellipsis points indicate that the preceding item can be repeated one or more times.

- . Vertical ellipsis points mean that irrelevant parts of a figure or example have been omitted.

Related Manuals

If you are using the DOMAIN system for the first time, you should read *Getting Started With Your DOMAIN System* (order number 002348) first. *Getting Started With Your DOMAIN System* teaches you the basics of using the DOMAIN system.

The *DOMAIN System Command Reference* (order number 002547) contains detailed descriptions of all DOMAIN system commands. The command descriptions are arranged alphabetically for quick and easy access.

For information on how to create the network environment, protect the network software, create servers, and maintain and troubleshoot the network, see *Administering Your DOMAIN System* (Order number 001746).

Problems, Questions, and Suggestions

We appreciate comments from the people who use our system. In order to make it easy for you to communicate with us, we provide the User Change Request (UCR) system for software-related comments, and the Reader's Response form for documentation comments. By using these formal channels you make it easy for us to respond to your comments.

You can get more information about how to submit a UCR by consulting the *DOMAIN System Command Reference*. Refer to the

CRUCR (Create User Change Request) Shell command description. You can view the same description on-line by typing:

\$ HELP CRUCR <RETURN>

For your documentation comments, we've included a Reader's Response form at the back of each manual.

Using the Stand-Up Binder

The plastic page lifter is designed to function as an easel for propping up the binder on your desktop. The following illustration shows how to use it.

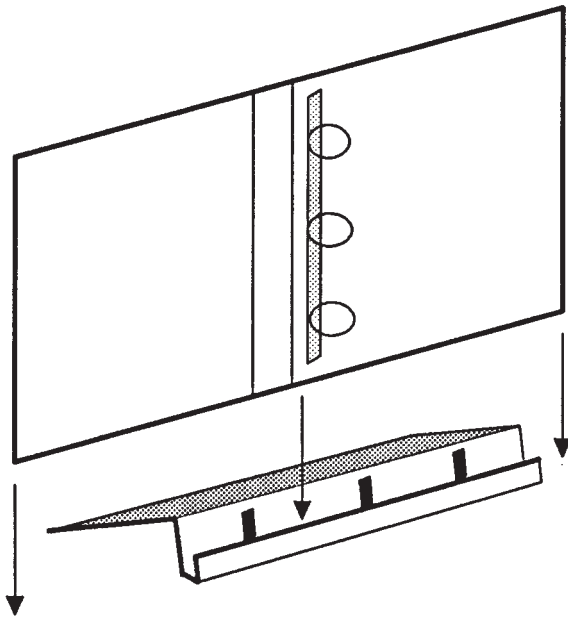

CONTENTS

Chapter 1 The DOMAIN System

Overview	1-2
The Naming Tree	1-4
Using Pathnames	1-6
The Working Directory	1-9
The Naming Directory	1-11
The Parent Directory	1-12
Pathname Summary	1-13

Chapter 2 Start-Up and Log-In

Understanding the System at Start-Up	2-2
Disked Node Start-Up	2-2
Diskless Node Start-Up	2-8
Understanding the System at Log-In	2-13
Logging In	2-20
Logging In as User	2-20
Changing Your Password	2-20
Changing Your Home Directory	2-21
Logging Into a DOMAIN Server Processor (DSP)	2-22

Chapter 3 Using The Display Manager

Using DM Commands	3-2
DM Command Conventions	3-4
Defining Points and Regions	3-6
Using Keys to Perform DM Functions	3-10
Keyboard Types and Key Definitions	3-12
Key Naming Conventions	3-15
Defining Keys	3-18
Deleting Key Definitions	3-21
Displaying Key Definitions	3-21

Controlling Keys from Within a Program	3-21
Using DM Command Scripts	3-22
Chapter 4 Controlling the Display	
Controlling Cursor Movement	4-2
Creating Processes	4-4
Creating a Process with Pads and Windows	4-5
Creating a Process without Pads and Windows	4-7
Creating a Server Process	4-8
Controlling a Process	4-8
Stopping a Program or Process	4-9
Suspending and Resuming a Process	4-10
Creating Pads and Windows	4-10
Creating an Edit Pad and Window	4-13
Creating a Read-Only Pad and Window	4-14
Copying a Pad and Window	4-15
Closing Pads and Windows	4-16
Managing Windows	4-17
Changing Window Size	4-18
Moving a Window	4-20
Pushing and Popping Windows	4-21
Changing Process Window Modes	4-22
Defining Default Window Positions	4-25
Responding to DM Alarms	4-26
Moving Pads Under Windows	4-27
Moving to the Top or Bottom of a Pad	4-27
Scrolling a Pad Vertically	4-28
Scrolling a Pad Horizontally	4-30
Saving a Transcript Pad in a File	4-30
Using Window Groups and Window Icons	4-31
Creating and Adding to Window Groups	4-31
Removing Entries from Window Groups	4-32
Making Windows Invisible	4-33
Using Icons	4-33
Setting Icon Default Position and Offset	4-36
Displaying the Members of a Window Group	4-37

Chapter 5 Editing a Pad

Setting Edit Pad Modes	5-2
Setting Read/Write Mode	5-3
Setting Insert/Overstrike Mode	5-4
Inserting Characters	5-4
Inserting a Text String	5-5
Inserting a NEWLINE Character	5-5
Inserting a New Line	5-6
Inserting an End-of-File Mark	5-6
Deleting Text	5-6
Deleting Characters	5-7
Deleting Words	5-7
Deleting Lines	5-8
Defining a Range of Text	5-9
Copying, Cutting, and Pasting Text	5-10
Using Paste Buffers.....	5 -11
Copying Text	5-12
Copying a Display Image	5-13
Cutting Text	5-14
Pasting Text	5-15
Using Regular Expressions	5-16
Searching for Text	5-23
Repeating a Search Operation	5-25
Cancelling a Search Operation	5-25
Setting Case Comparison	5-25
Substituting Text	5-26
Substituting All Occurrences of a String	5-27
Substituting the First Occurrence of a String	5-28
Changing the Case of Letters	5-28
Undoing Previous Commands	5-29
Updating an Edit File	5-29

Chapter 6 Using the Shell

Shell Commands	6-2
Command Line Format	6-3
Standard Command Options	6-4

Command Search Rules	6-5
Special Characters	6-7
Creating and Invoking Shells	6-7
Setting Up the Initial Shell Environment	6-8
Controlling Input and Output	6-9
Reading Input from a File	6-11
Writing Output to a File	6-12
Appending Output to a File	6-12
Redirecting Output to Other Commands	6-13
The Command Line Parser	6-14
Using Query Options	6-15
Reading Data from Standard Input	6-16
Reading Pathnames from Standard Input	6-17
Using Pathname Wildcards	6-18
Running Programs in a Background Process	6-22

Chapter 7 Managing Files, Directories, and Links

Moving Around the Naming Tree	7-2
Setting the Working Directory	7-3
Setting the Naming Directory	7-3
Managing Files	7-5
Creating Files	7-5
Renaming Files	7-7
Copying Files	7-8
Moving Files	7-9
Appending Files	7-10
Printing Files	7-11
Printing Files Using the Print Menu Interface	7-13
Displaying File Attributes	7-16
Deleting Files	7-18
Copying the Display to a File	7-18
Comparing ASCII Files	7-19
Managing Directories	7-20
Creating Directories	7-21
Renaming Directories	7-21
Copying Directory Trees	7-22
Replacing Directory Trees	7-25
Merging Directory Trees	7-26
Comparing Directory Trees	7-27

Displaying Directory Information	7-28
Deleting Directory Trees	7-30
Managing Links	7-31
Creating Links	7-32
Displaying Link Resolution Names	7-33
Redefining Links	7-33
Renaming Links	7-34
Copying Links	7-35
Deleting Links	7-36

Chapter 8 Controlling Access to Files and Directories

ACL Structure	8-2
The Subject Identifier (SID)	8-3
Access Rights	8-4
Understanding SEARCH and EXPUNGE Rights	8-7
Managing ACLs	8-7
Displaying ACLs	8-8
Editing ACLs	8-9
Rules to Specify ACL Entries	8-11
Adding ACL Entries	8-15
Changing Entry Rights	8-15
Adding Entry Rights	8-16
Deleting Entry Rights	8-17
Deleting ACL Entries	8-17
Copying ACLs	8-18
Initial ACLs	8-18
Editing Initial ACLs	8-20
Copying Initial ACLs	8-21
Protected Subsystems	8-22
How Do Protected Subsystems Work?	8-23
Creating a Protected Subsystem	8-26
Assigning Protected Subsystem Status	8-27

Chapter 9 Writing Shell Scripts

Creating Your Own Commands	9-2
Creating Scripts	9-2
Passing Arguments to Scripts	9-4
Using Quoted Strings	9-8
Using In-Line Data	9-9
Executing DM Commands from Shell Scripts	9-10
Debugging Shell Scripts	9-10
Using Expressions	9-12
Operands in Expressions	9-14
Mathematical Operators	9-14
String Operators	9-15
Comparison Operators	9-16
Logical Operators	9-17
Shell Variables	9-18
Defining Variables	9-18
Using Shell Variables	9-19
Variable Commands	9-21
Defining Variables Interactively	9-22
Using Active Functions	9-24
Controlling Script Execution	9-25
Using the IF Statement	9-28
Using the WHILE Statement	9-29
Using the FOR Statement	9-31
Using the SELECT Statement	9-34

Appendix A Initial Directory and File Structure

Appendix B Summary of Predefined Key Definitions

Index

Illustrations

Figure		Page
1-1	A Simple DOMAIN Network	1-2
1-2	A Sample Naming Tree	1-4
1-3	A Sample Path Through the Naming Tree	1-7
1-4	A Sample Path Beginning at the Node Entry Directory	1-8
1-5	A Sample Path Beginning at the Current Working Directory	1-10
1-6	A Sample Path Beginning at the Current Naming Directory	1-12
1-7	A Sample Path Beginning at the Parent Directory	1-13
2-1	The Start-Up Sequence for Disked Nodes	2-3
2-2	A Sample Boot Script (STARTUP.19L)	2-6
2-3	The Start-Up Sequence for a Diskless Node	2-9
2-4	The Boot Script Search Sequence	2-13
2-5	The Log-In Sequence	2-14
2-6	A Sample Log-In Start-Up Script (STARTUP_LOGIN.19L)	2-17
2-7	A Sample DM Start-Up Script (STARTUP_DM.19L)	2-19
3-1	Invoking a DM Command Interactively	3-3
3-2	Defining a Display Region	3-9
3-3	Key Names for the Low-Profile Type Keyboards	3-13
4-1	A Process Running the Shell	4-6
4-2	Creating an Edit Pad and Window	4-13
4-3	Copying a Pad and Window	4-15
4-4	Growing a Window Using Rubberbanding	4-19
4-5	Pushing and Popping Windows	4-21

4-6	Process Window Legend	4-23
4-7	Location of Pad Scroll Keys	4-29
4-8	Default Icon for Shell Process Windows	4-34
5-1	The Edit Pad Window Legend	5-3
5-2	Defining a Range of Text with <MARK>	5-10
5-3	Copying Text with the XC -R Command	5-13
6-1	The Shell Process	6-2
6-2	Shell Command Line Components	6-3
6-3	Sample Shell Start-Up Script	6-9
7 -1	The Print Menu	7-13
7-2	Print “Commands” Submenu	7-15
7-3	Sample Display Showing File Attributes	7-17
7-4	Comparing Two ASCII Files	7-19
7-5	Sample Directory Tree	7-23
7-6	Copying a Directory Tree	7-24
7-7	Replacing a Directory Tree	7-25
7-8	Comparing Directory Trees	7-28
7-9	Sample Directory Display	7-29
7-10	Deleting a Directory Tree	7-30
7-11	Sample Display of Link Resolution Names	7-33
8-1	Structure of an ACL Entry	8-2
8-2	Sample ACL Entries	8-3
8-3	Sample ACL Display	8-8
8-4	Initial ACLs for Files and Directories	8-19
8-5	Controlling Access to Protected Subsystem Files	8-24
8-6	Sample of a Protected Subsystem Transcript	8-28
9-1	Including In-Line Data in a Script	9-9
9-2	A Sample Script Using the READ Command	9-23
9-3	Flow of Execution in a Simple Script	9-26
9-4	Flow of Execution with a Conditional Statement	9-27
A-1	The Node Entry Directory (/) and Subdirectories	A-2
A-2	The System Software Directory	A-3

A-3	The Display Manager Directory (/SYS/DM)	A-4
A-4	The Network Management Directory (/SYS/NET)	A-5
B-1	Keynames for the 880 Keyboard	B-2

Tables

Table		Page
1-1	Pathname Symbols	1-9
2-1	Node Boot Script Files	2-5
2-2	Node Log-In Start-Up Script Files	2-16
3-1	Rules for Using DM Special Characters	3-5
3-2	Formats for Specifying Points on the Display	3-7
3-3	Default Mouse Key Functions	3-11
3-4	Key Definition File Names	3-14
3-5	Key Naming Conventions	3-16
4-1	Cursor Control Commands	4-2
4-2	Commands for Creating Processes	4-5
4-3	Commands for Controlling a Process	4-9
4-4	Commands for Creating Pads and Windows	4-10
4-5	DM Rules for Defining Window Boundaries	4-11
4-6	Commands for Closing Pads and Windows	4-16
4-7	Commands for Managing Windows	4-18
4-8	Process Window Modes	4-23
4-9	Commands for Moving Pads	4-27
4-10	Commands for Controlling Window Groups and Icons	4-31
4-11	Window Paste Buffers	4-38
5-1	Commands for Setting Edit Modes	5-2
5-2	Commands for Inserting Characters	5-5
5-3	Commands for Deleting Text	5-7
5-4	Commands for Copying, Cutting, and Pasting Text	5-11
5-5	Characters Used in Regular Expressions	5-17
5-6	Commands for Searching for Text	5-23
5-7	Commands for Substituting Text	5-26
6-1	Standard Shell Command Options	6-5

6-2	I/O Control Characters	6-11
6-3	Command Line Parser Options	6-15
6-4	Command Query Responses	6-16
6-5	Summary of Pathname Wildcards	6-19
7-1	Commands for Setting the Working and Naming Directory	7-2
7-2	Commands for Managing Files	7-5
7-3	Print “Commands” Submenu Items	7-16
7-4	Commands for Managing Directories	7-20
7-5	Commands for Managing Links	7-31
8-1	Access Rights for Files and Directories	8-6
8-2	Summary of Commands for Editing ACLs	8-10
8-3	Valid Rights for Files and Directories	8-12
8-4	Class Names for Commonly Assigned Rights	8-14
8-5	Summary of Commands for Editing and Copying Initial ACLs	8-20
8-6	Options for Copying Initial ACLs	8-22
9-1	Shell Parsing Operators	9-3
9-2	Script Verification Options	9-11
9-3	Summary of Expression Operators	9-13
9-4	Rules for Assigning Variable Types	9-19
9-5	Variable Commands	9-21

The DOMAIN System

The DOMAIN system is a high-speed communications network connecting two or more of our computers, called **nodes**. Each node loads programs into its own memory, and uses the computing functions of its own central processing unit (CPU). Because the DOMAIN system enables nodes to share information, you can log into any node and access information stored anywhere in the network.

Many of the operations you'll perform on the system involve the use of **objects** (files, directories, and links) that store information such as programs, data, or text. Before you can work with these objects, you must understand how the system organizes and identifies them.

This chapter describes the DOMAIN system, how it organizes objects in the system naming tree, and how to use pathnames to identify these objects.

Overview

The DOMAIN system uses a physical network, in which member nodes can load data from the network into memory just as they would load data from their own disk.

The *DOMAIN System Site Planning and Preparation Guide* describes the DOMAIN network in much more detail. For our purposes, we're interested in the network to see how nodes use the system to share information. Figure 1-1 shows a simple DOMAIN network composed of three nodes and two disks.

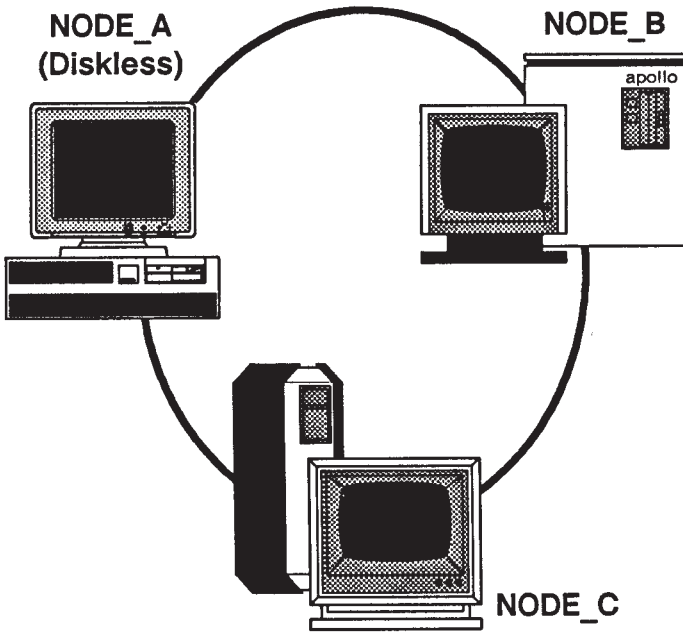

Figure 1-1. A Simple DOMAIN Network

The DOMAIN system makes the information on all disks available to any node in the DOMAIN network. For example, in Figure 1-1, *NODE_C* can access information stored on its own disk, as well as information stored on the disk connected to *NODE_B*. Although *NODE_A* doesn't have its own disk, it can, via the network, access information stored on the disks connected to *NODE_B* or *NODE_C*.

Each node in the network requires the use of at least one disk, called a **boot volume**, that contains the operating system and other system software it needs to run. Some nodes, called **disked nodes**, are physically connected to the disk that they use as the boot volume. Other nodes, called **diskless nodes**, share the boot volume of some other disked node in the network, called a **network partner**. In Figure 1-1, *NODE_B* and *NODE_C* are disked nodes. Because *NODE_A* is a diskless node, it must use either *NODE_B* or *NODE_C* as its partner.

To run in the network, a diskless node must have a network partner. The network partner's disk provides all of the necessary operating system and support software for the diskless node. Because a diskless node relies on its partner for system software, it can operate only when the partner node is operating. If the partner node is removed from the network while the diskless node is running, the diskless node will crash.

The operating system interface on each node, whether disked or diskless, is made up of two main programs: the **Display Manager (DM)** and the **Shell**.

The DM is the system program that controls your node's display and enables you to create processes. The DM listens for DM commands that you specify in the DM command input pad of your display. Part II of this manual describes your node's display environment and how to use the DM to control this environment.

The Shell is the program that you use to perform more traditional computing operations such as managing files, and compiling programs. The Shell listens for commands that you specify in the Shell process's command input pad. Each command invokes a different utility program that performs a specific computing operation. Part III of this manual describes the Shell program and the Shell commands you use to perform standard computing operations.

The Naming Tree

To make information available to all the nodes in the network, the DOMAIN system organizes objects in a hierarchical structure called a **naming tree**. The naming tree serves as a type of map that the system uses to keep track of where objects reside in the network. To access an object, you refer to its location in the naming tree. Figure 1-2 shows a sample naming tree.

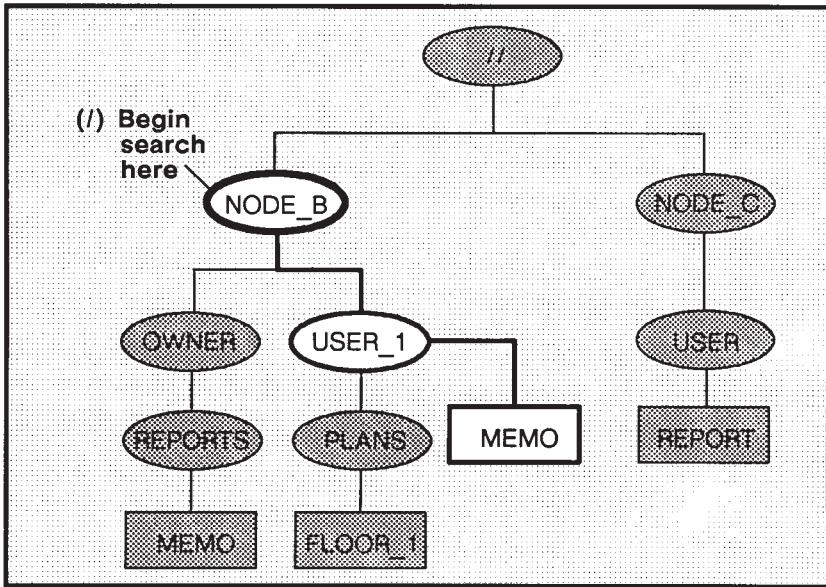

Figure 1-2. A Sample Naming Tree

The double slashes (**//**) in Figure 1-2 represent the top level of the naming tree, the **network root directory**. Each node maintains its own copy of the network root directory, which contains the name of each **node entry directory** the node can access. Figure 1-2 shows a

network root directory containing the names of two node entry directories: *NODE_B* and *NODE_C*.

Each disked node in the network has a node entry directory name associated with it. This name refers to the branch of the naming tree that resides on its disk. (Since diskless nodes don't have disks, they use the node entry directory of their partner.) In Figure 1-2, all of the objects under the node entry directory, *NODE_B*, reside on the disk *NODE_B*, while all of the objects under the node entry directory *NODE_C* reside on the disk *NODE_C*. In other words, each disk in the network represents an entry directory in the system naming tree.

Entry directories contain one or more **upper-level directories**. An upper-level directory is one level below the entry directory and normally serves as the main directory for a branch of logically related objects. For example, the */SYS* directory that we supply is an upper-level directory that contains many of the system objects that make up the operating system. (Appendix A contains a set of figures that illustrate how the system organizes the software we supply with your node.) An upper-level directory can also serve as a user's main directory for storing files.

In Figure 1-2, the directories *OWNER* and *USER_I* are upper-level directories, one level below the entry directory *NODE_B*. The directory *OWNER* serves as the main directory for all objects that belong to the owner of the node. The upper-level directory *USER_I* is the main directory for the user of a diskless node (*NODE_A*) that uses *NODE_B* as its entry directory. The directory *USER* serves as the main directory for the user on *NODE_C*.

In summary, the network root directory contains the names of node entry directories in the network. The system uses your node's network root directory to determine which node entry directories in the network it can access. Each node entry directory contains one or more upper-level directories. An upper-level directory serves as the main directory for logically related objects.

Your node can access only the node entry directories whose names appear in the local copy of the network root directory. To keep your local copy of the network root directory up to date, you should **catalog** new disked nodes as they are added to the network. To catalog new nodes, use the Shell command **CTNODE**

(**CATALOG_NODE**) described in the *DOMAIN System Command Reference*.

Some network sites use the **NS_HELPER (Naming Server Helper)** to maintain an up-to-date network root directory. If your site uses **NS_HELPER**, you don't need to use **CTNODE** to catalog nodes; **NS_HELPER** does it for you. To find out if your network site uses the **NS_HELPER**, ask your system administrator. *Administering Your DOMAIN System* describes **NS_HELPER** and explains how to catalog nodes to update the network root directory.

Using Pathnames

The system identifies each object in the naming tree by its unique location. Whenever you specify a command to create or access an object, you also specify a **pathname** that points to the object's location in the naming tree. The pathname tells the system what path to follow when searching for an object.

The commands you use to create and manage objects require you to specify a pathname as a command argument. When you invoke a command, the command specifies the operation, and the pathname tells the system where in the naming tree to perform it.

For example, the following Shell command deletes the file **MEMO** in the naming tree shown in Figure 1-3:

```
$ DLF //NODE_B/USER_1/MEMO
```

command pathname

The Shell command **DLF (DELETE_FILE)** tells the system to delete the file at the location specified by the pathname. Figure 1-3 shows the path the system follows to the file.

The pathname directs the system to:

1. Start at the network root directory (`//`).
2. Follow the path through the entry directory, `NODE_B`, and the subdirectory, `USER_1`.
3. Stop at the file, `MEMO`.

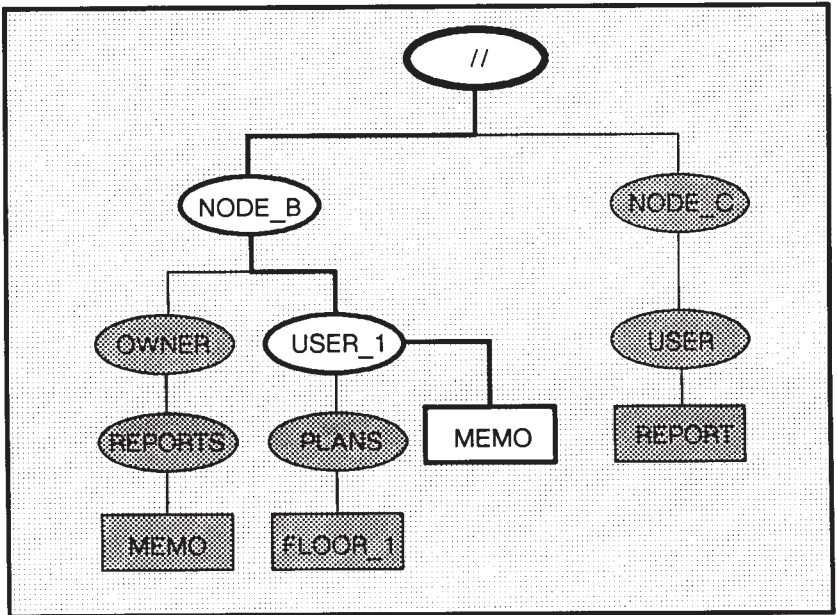

Figure 1-3. A Sample Path Through the Naming Tree

When the system searches for a location in the naming tree, it begins its search at some point in the tree and follows a path to the location. The pathname in the previous examples explicitly specified the network root directory as the starting point for the system's search through the naming tree. (The double slashes (`//`) at the beginning of the pathname specify the network root directory.) This type of pathname, called an **absolute pathname**, tells the system the full path, from the network root directory to the final location.

You don't have to begin pathnames with the network root directory specification. For example, the single slash (/) symbol directs the system to begin its search at your node's entry directory. Here is an example using the single slash to start a search at your node's entry directory:

```
$ DLF /USER_1/MEMO
```

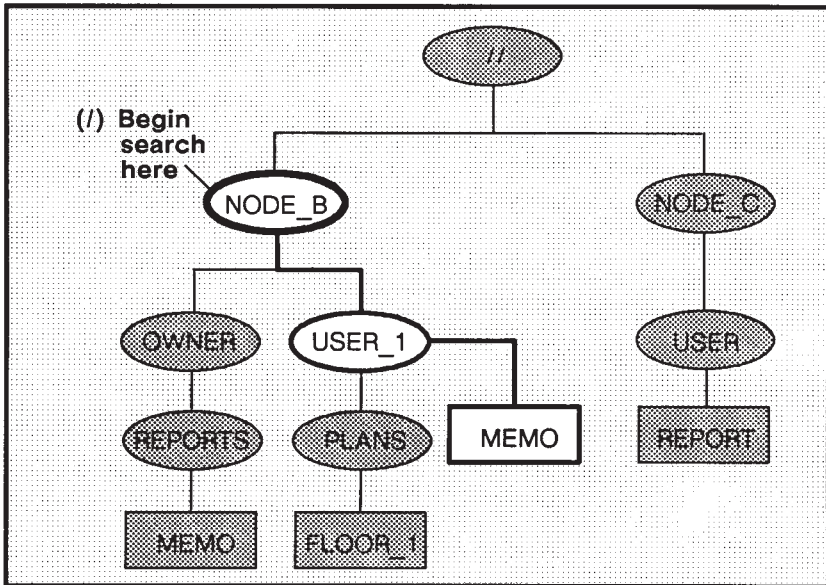

Figure 1-4. A Sample Path Beginning at the Node Entry Directory

For this example, let's assume that your node's entry directory is *NODE_B*. As shown in Figure 1-4, the pathname directs the system to:

1. Start at your node's entry directory, *NODE_B*.
2. Follow the path through the upper-level directory, *USER_1*.
3. Stop at the file, *MEMO*.

You can specify other starting points in the naming tree by beginning a pathname with any of the symbols in Table 1-1.

Table 1-1. Pathname Symbols

Symbol	System starts search at:
//	Network root directory
/	Node entry directory
No symbol or .	Working directory
~	Naming directory
\	Parent directory

The Working Directory

If you specify a pathname without a symbol preceding it (or if you precede the pathname with a period) the system starts its search at a default location in the naming tree called the **working directory**. Think of the working directory as the directory location in which you are currently working. Each process that you create uses one of the directories in the naming tree as its working directory.

When you log into a node, the system creates a process running the Shell program and sets that process's working directory to the **home directory** name designated in your user account. (Chapter 2 describes your home directory and how to change it at log-in.) The system uses this directory as your working directory unless you change it to another directory. (Chapter 7 describes how to change your working directory.)

The following command deletes the file *MEMO* in the current working directory:

```
$ DLF MEMO
```

In this example, let's assume that the current working directory is the directory *REPORTS*. As shown in Figure 1-5, the system begins its search at *REPORTS* and deletes the file *MEMO*.

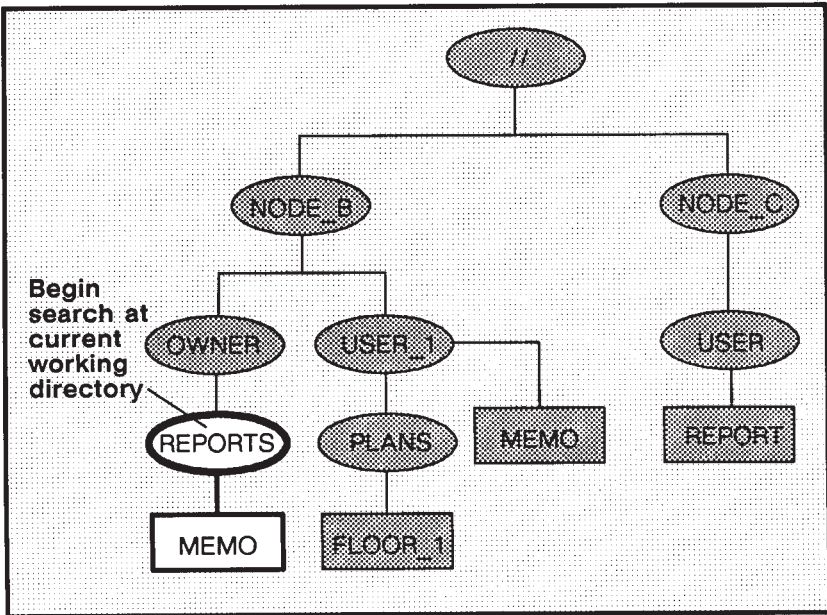

Figure 1-5. A Sample Path Beginning at the Current Working Directory

You'll notice in Figure 1-5 that another file named *MEMO* exists at another location in the naming tree (in the directory *USER_1*). If the current working directory was *USER_1* instead of *REPORTS*, the command in our example would delete this file instead. So you see, a pathname that starts at the working directory functions differently depending on the directory currently being used as the working directory.

The Naming Directory

If you precede a pathname with the **tilde** (`~`) symbol, the system starts its search at a location in the naming tree called the **naming directory**. Like the working directory, each process has a naming directory that points to some directory in the naming tree.

When you log into a node, the system creates a process running the Shell program and sets that process's naming directory to the home directory name designated in your user account. The system uses this directory as your naming directory unless you change it to another directory. (Chapter 7 describes how to change your naming directory.)

The following command deletes the file *MEMO* in the current naming directory:

```
$ DLF ~REPORTS/MEMO
```

In this example, let's assume that the current naming directory is the upper-level directory *OWNER*. As shown in Figure 1-6, the pathname directs the system to:

1. Start at your node's naming directory, *OWNER*.
2. Follow the path through the directory, *REPORTS*.
3. Stop at the file, *MEMO*.

Like pathnames that use the current working directory, pathnames starting at the naming directory work differently depending on the directory currently being used as the naming directory.

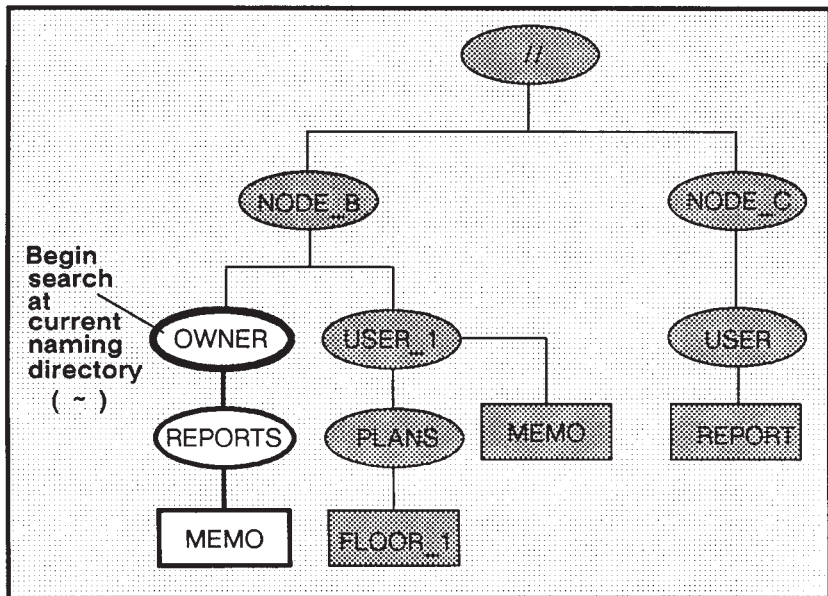

Figure 1-6. A Sample Path Beginning at the Current Naming Directory

The Parent Directory

If you precede the pathname with a backslash (\) symbol, the system starts its search at a location called the **parent directory**. A parent directory is the directory one level above the current working directory. For example, the following command uses the \ symbol to delete the file MEMO in the directory USER_1:

```
$ DLF \MEMO
```

In this example, let's assume that the current working directory is the directory PLANS. As shown in Figure 1-7, the system begins its search at the directory USER_1 (the parent directory of the current working directory PLANS) and deletes the file MEMO.

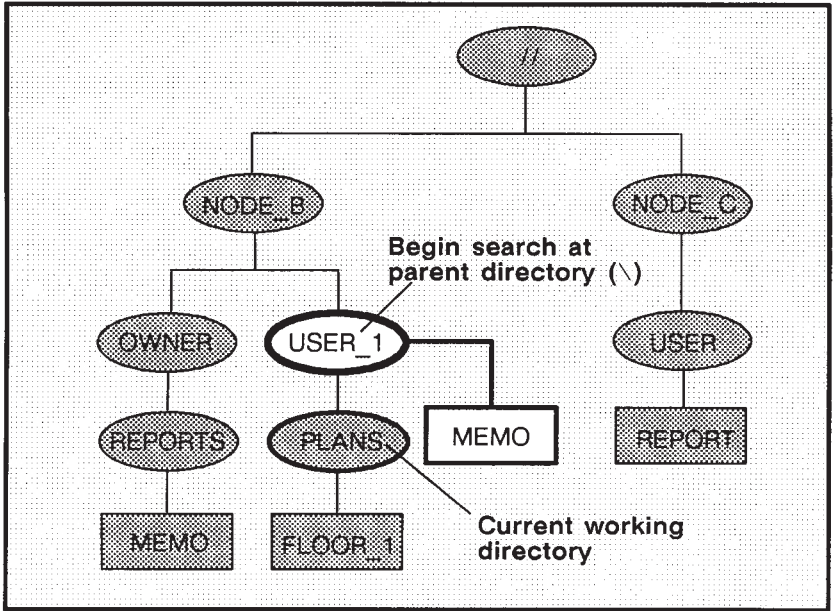

Figure 1-7. A Sample Path Beginning at the Parent Directory

Pathname Summary

In this section, you learned how to use pathnames to point to objects in the system naming tree. The examples showed you how to use pathnames with commands to tell the system the naming tree location where you want a particular operation performed.

Pathnames also serve to identify objects. As you read through this manual, you will find that many of the objects that make up the operating system are referred to by their pathnames. For example, Chapter 2 describes many of the objects the system uses at start-up and log-in. By understanding which objects the system uses and where they are located, you'll better understand how these objects work together to make up a functioning system.

Appendix A contains a set of figures that illustrate how the system organizes the system software that we supply with your node. These figures also refer to system objects by their pathnames.

Start-Up and Log-In

Each time you start up a node and log in to it, the DOMAIN system executes various programs that start the operating system, and scripts that set up the node's operating environment. You can tailor the operating environment on your node by modifying the scripts the system uses at start-up and log-in. For example, you may want to start specific server processes when you start up your node. Or, you may want your own specific key definitions, default window positions, and tabs defined each time you log in.

This chapter describes how the system functions at start-up and log-in, and describes the steps you can take to tailor your operating environment. The chapter also describes procedures for changing your password and log-in home directory when you log in.

Understanding the System at Start-Up

The *Owner's Guide* for your node describes the proper procedure for starting it up. When you initiate the node's start-up by turning on the power, the node performs a series of operations to **boot** the operating system (load the operating system from disk into memory) and begin executing it. The operating system then executes a series of start-up files to set up the operating environment on your node.

This section explains the sequence of events occurring at start-up for both disked and diskless nodes.

Disked Node Start-Up

If your node is a disked node, it reads the programs it needs for start-up from its own disk. The flowchart in Figure 2-1 shows the start-up sequence on a disked node.

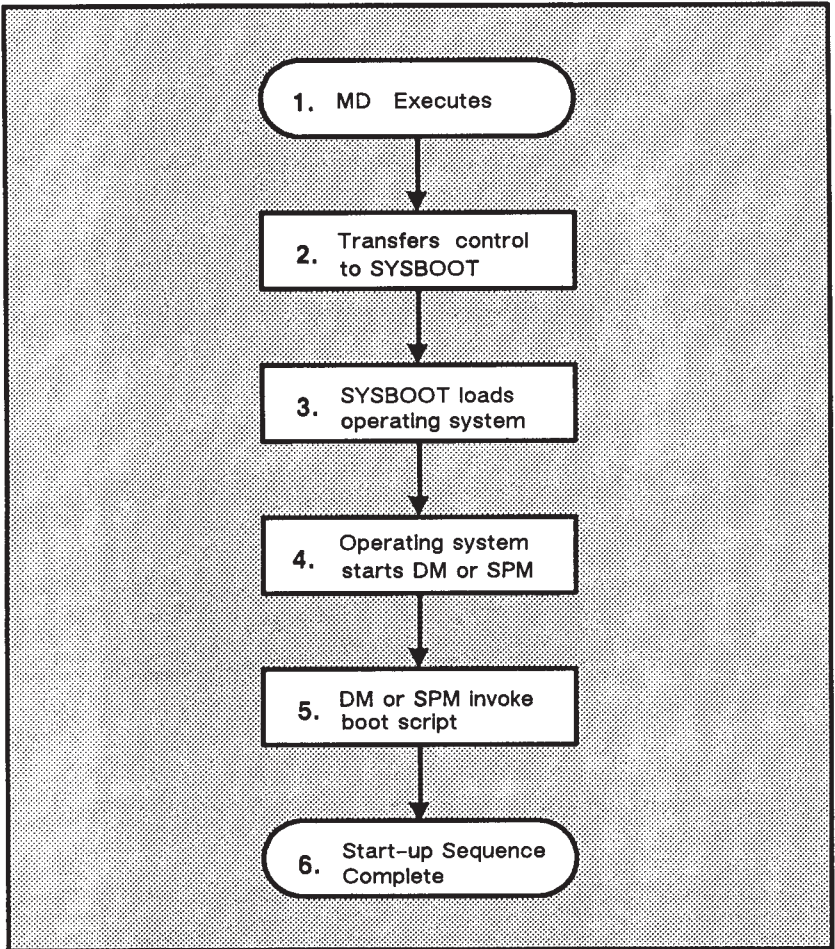

Figure 2-1. The Start-Up Sequence for Disked Nodes

The descriptions that follow explain each step in the start-up sequence shown in Figure 2-1.

1. When you power on your node in NORMAL mode (follow the instructions in your *Owner's Guide*), a program called the **Mnemonic Debugger (MD)** begins executing. The MD

resides in the node's boot **PROM (Programmable Read- Only Memory)**.

2. The MD reads a program called **SYSBOOT** from your node's disk and loads it into the CPU's memory. The MD then transfers control to SYSBOOT. SYSBOOT, as its name indicates, is the program responsible for booting the operating system.
3. The SYSBOOT program loads the operating system into the CPU's memory. Once loaded, the operating system begins executing and takes control.
4. The operating system starts either:
 - The **Display Manager (DM)** on nodes with displays.
 - The **Server Process Manager (SPM)** on DOMAIN Server Processors (DSPs). The SPM is the server program that allows you to create a process on a DSP from a remote node in the network. (For more information about the SPM, see *Administering Your DOMAIN System*.)
5. The DM or the SPM executes a start-up file, called a **boot script**, that sets up the initial operating environment on your node. Table 2-1 lists the different boot script files used at start-up. As shown in Table 2-1, the system chooses which boot script file to execute according to the type of node.

All of the boot script files listed in Table 2-1 reside in the directory `'NODE_DATA`. The grave accent (`'`) that precedes the directory name is a special symbol that returns a value for `NODE_DATA`. For example, on disked nodes, `'NODE_DATA` points to the directory `/SYS/NODE_DATA` on the node's disk. On diskless nodes, `'NODE_DATA` points to the directory `/SYS/NODE_DATA.node_id` on the partner node's disk. The `node_id` suffix refers to the diskless node's hexadecimal node ID. (Refer to the "Diskless Node Start-Up" section for more information on diskless node start-up.)

Table 2-1. Node Boot Script Files

Node Type	Boot Script Filename
800x1024 (Portrait) DN400	STARTUP
1024x800 (Landscape) DN420, DN460, DN3xx, DN550, DN560, DN570, DN3000 (color)	STARTUP.19L
1280x1024 (Color Landscape) DN580	STARTUP.1280COLOR
1280x1024 (Black & White Landscape) DN3000 (Black & White)	STARTUP.1280BW
1024x1024 (Color) DN600	STARTUP.COLOR
Displayless DOMAIN Server Processor (DSPs)	STARTUP.SPM

Figure 2-2 shows a sample boot script similar to the one we provide with DN3xx nodes. The boot scripts for other nodes are similar.

```

# 'NODE_DATA/STARTUP, default system startup
# command file for 19L, 4/21/83
# Default is black characters on white (or green)
# background.
INV -ON
(608,744)dr; (1023,799)cv /sys/dm/output
(556,744)dr; (608,799)cv /sys/dm/output;pb
(0,744)dr; (556,799)cv /sys/dm/input
# To enable the diskless node boot server,
# uncomment the following CPS command.
#
# cps /sys/net/netman
# To startup default printer
#
# cps /com/sh -c '/com/prsvr' -n print_server
# To enable the summagraphic bit pad support,
# uncomment the following CPS command.
#
# cps /sys/dm/sbp1 /dev/sio2 L
# To startup mbx (IPC) helper
#
# cps /sys/mbx/mbx_helper
# To Properly define the keys for the 880 keyboard,
# uncomment the following command.
#
# kbd
# To properly define the keys for the low-profile
# keyboard (KBD2), uncomment the following
# command.
#
# kbd 2
# To properly define the keys for the low-profile
# keyboard with the numeric keypad, uncomment the
# following command.
#
# kbd 3

```

Figure 2-2. A Sample Boot Script (STARTUP.19L)

The boot script contains commands that start various server programs. These server programs run regardless of log-in and log-out activity and provide various system services to the node. For example, the NETMAN program makes the node available as a host for diskless partners, and the print server program (PRSVR) runs peripheral printers. For a description of these and all of the DOMAIN server programs, see *Administering Your DOMAIN System*.

If you want your node to automatically start any of these server programs, edit your node's boot script and remove the pound sign (#) from the command line that invokes the server. Note, however, that the system will not start any of these servers until the next time you shut down and restart your node. (See your node's Owner's Guide for node startup and shutdown procedures.)

The boot scripts that run on nodes that have displays contain a set of commands that instruct the Display Manager to draw the initial display windows on the screen. One of the windows contains the "Please log in:" prompt.

These boot scripts also contain commands that specify which type of keyboard the node is using. If your node uses the DOMAIN Low-profile Model I keyboard, remove the # from the KBD2 command. If your node uses the low-profile keyboard with the numeric keypad (DOMAIN Low-profile Model II keyboard), remove the # from the KBD3 command. See the "Using Keys to Perform DM Functions" section in Chapter 3 for a description of keyboard types.

Note: On DN3000 nodes, use of the KBD 3 command is optional; KBD 3 is assumed by default.

The *STARTUP.SPM* script used by DSPs is similar to the other start-up scripts. However, since DSPs don't have displays, *STARTUP.SPM* doesn't contain commands for creating windows.

6. Once the boot script finishes executing, the node start-up completes, and the system prompts you to log in.

Diskless Node Start-Up

The start-up sequence for diskless nodes is somewhat different than the start-up sequence for disked nodes. A diskless node does not have its own disk to store the operating system and other software files it needs to run. Therefore, each time it starts up, the diskless node must load parts of the operating system across the network from its partner node. The diskless node also relies on its partner for any utility programs and libraries it needs. Figure 2-3 presents a flowchart showing the start-up sequence for a diskless node.

From your perspective as a user, starting up a diskless node is the same as starting up a disked node; you turn the power on in **NORMAL** mode and wait for the log-in prompt to appear. However, the start-up sequence that goes on internally is somewhat different. The descriptions that follow explain each step in the diskless node start-up sequence shown in Figure 2-3. Once you've read the descriptions, go back and compare each step with the disked node start-up sequence described in the "Disked Node Start-Up" section.

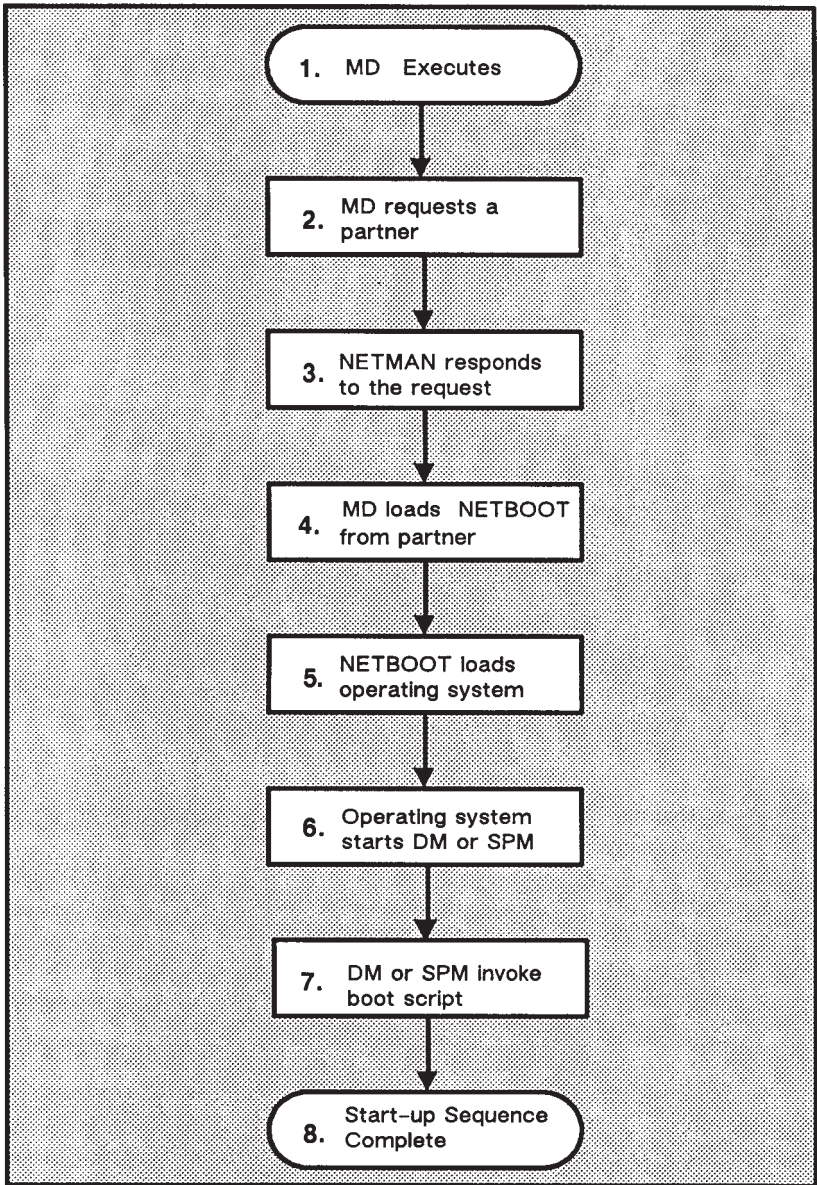

Figure 2-3. The Start-Up Sequence for a Diskless Node

1. When you power on your node in NORMAL mode (by following the instructions in your *Owner's Guide*), a program called the Mnemonic Debugger (MD) begins executing. The MD resides in the node's boot PROM (Programmable Read-Only Memory).
2. Because a diskless node does not have a disk, the MD cannot load SYSBOOT and transfer control to it. Instead, the MD must boot the system from another disked node in the network. The MD then broadcasts a message across the network asking for a partner node to volunteer the use of its boot volume.
3. All nodes running the NETMAN program receive these request messages (NETMAN's purpose is to respond to them). In response to the diskless node's request, NETMAN on a disked node checks the file */SYS/NET/DISKLESS_LIST*. This file on the disked node contains a list of hexadecimal node IDs for all nodes the disked node may offer partnership.

If the diskless list contains the ID of the diskless node requesting partnership, NETMAN volunteers the node as a partner. The first disked node to volunteer becomes the partner of the diskless node. (It remains the diskless node's partner until the next time the diskless node boots.) At this point, the diskless node displays the partner node's node ID for your information.

You can take a look at a sample diskless list by reading the file */SYS/NET/SAMPLE_DISKLESS_LIST*. For a complete description of how to create a diskless list and set up partners for diskless nodes, see *Administering Your DOMAIN System*.

4. Once the diskless node finds a partner, the MD copies the **NETBOOT** program from the file, */SYS/NET/NETBOOT* on the partner node into the diskless node's memory. The NETBOOT program is a special version of SYSBOOT that diskless nodes use to boot the operating system across the

network. The MD, when finished loading NETBOOT, transfers control to it.

5. The NETBOOT program, running on the diskless node, loads the operating system from the partner node's boot volume into memory.
6. The operating system starts either:
 - The Display Manager (DM) on nodes with displays.
 - The Server Process Manager (SPM) on DOMAIN Server Processors (DSPs). The SPM is the server program that allows you to create a process on a DSP from a remote node in the network. (Refer to *Administering Your DOMAIN System* for more information about the SPM.)
7. The DM or the SPM executes a start-up file, called a boot script, that sets up the initial operating environment on your node. Table 2-1 lists the different boot script files used at start-up. As shown in Table 2-1, the system chooses which boot script file to execute according to the type of node.

Since diskless nodes don't have files of their own, the DM or SPM must look to the partner node to find its boot script file. Just as on a disked node, the DM or SPM on a diskless node searches for the boot script file in the directory `'NODE_DATA`. (The grave accent (`'`) that precedes the directory name is a special symbol that returns a value for `NODE_DATA`.) Unlike a disked node, however, `'NODE_DATA` for the diskless node points to the directory `/SYS/NODE_DATA.node-id` on the partner's disk. (The node-id suffix is the hexadecimal node ID of your diskless node.)

Once the DM or SPM finds the diskless node's boot script, the boot script executes. Figure 2-2 shows a sample boot script similar to the one we provide with DN3xx nodes. For information about this script refer to the "Understanding the System at Log-In" section.

A single disked node can serve as the partner for several diskless nodes. Each diskless node may need to use a

“node-specific” boot script to set up its own unique operating environment. Therefore, the system uses the *node-id* suffix to denote a unique boot script location for each diskless node assigned to the partner.

At start-up, if the partner does not have a *NODE_DATA* directory set up for the diskless node, NETMAN creates one, copying it from a template stored in the partner’s *NODE_DATA* directory. The NETMAN program then copies the partner node’s boot script file into the diskless node’s *NODE_DATA* directory. If you want the newly created boot script to perform different operations at startup than its partner, edit the boot script.

8. Once the boot script finishes executing, the node start-up completes, and the system prompts you to log in.

A major difference between the disked node and diskless node startup sequence is the step where the DM or SPM searches for the node’s boot script (Step 7 for diskless nodes and Step 5 for disked nodes). Figure 2-4 presents a flowchart that summarizes this search.

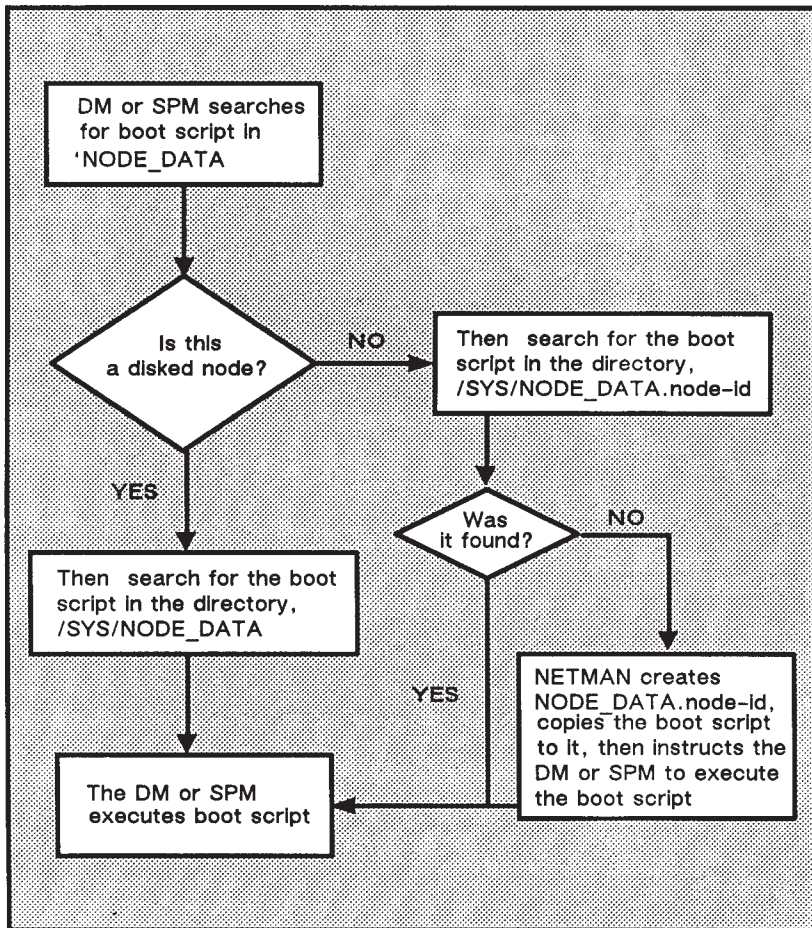

Figure 2-4. The Boot Script Search Sequence

Understanding the System at Log-In

Once a node is up and running, you are ready to log in. At log-in, the system executes a series of scripts that set up the working environment for your log-in session. This section describes the sequence of steps the system performs at log-in. This section also shows you how to create and modify scripts to tailor your log-in en-

vironment. The flowchart in Figure 2-5 shows the log-in sequence for a node.

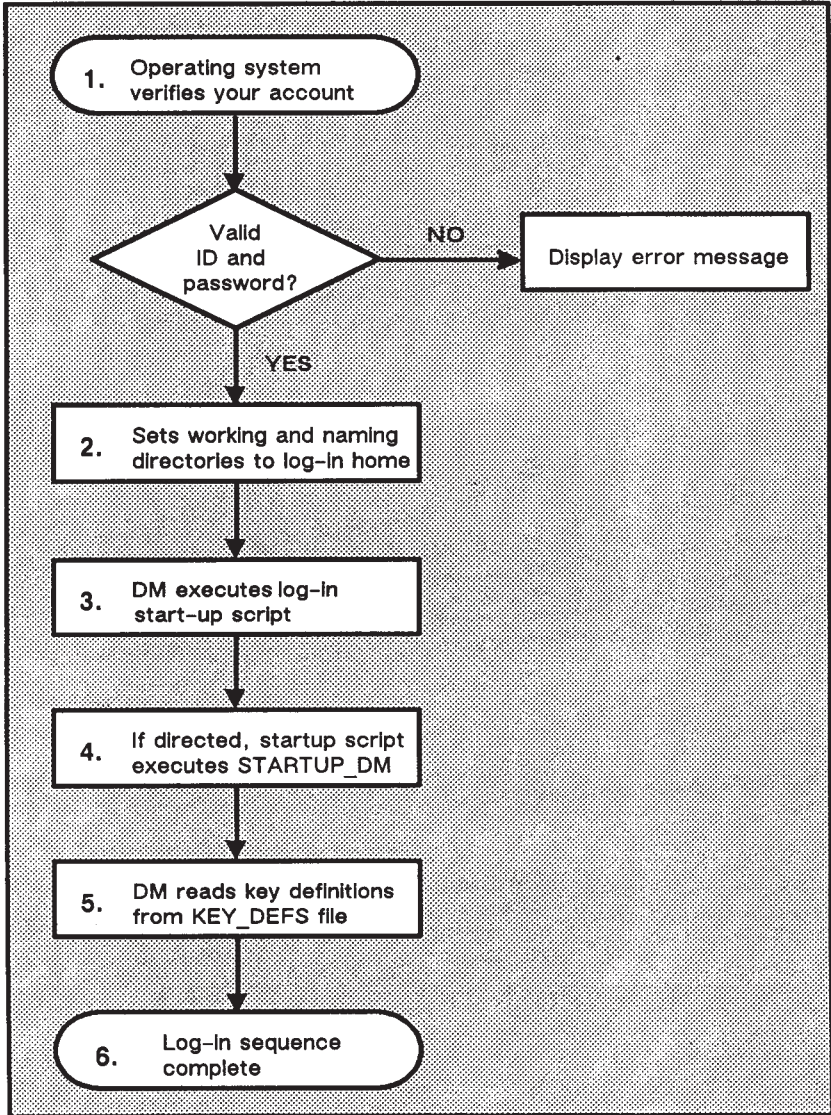

Figure 2-5. The Log-In Sequence

The descriptions that follow explain each step in the log-in sequence shown in Figure 2-5.

1. After you enter your username and password, the operating system verifies your account. (Chapter 1 in *Getting Started With Your DOMAIN System* describes how to log in.)

The system verifies your account by checking the file *ACCOUNT* in the site registry directory. If the username and password match a valid account in the *ACCOUNT* file, the system executes the next step. If the system cannot verify the account, the log-in attempt fails, and the system displays a log-in error message in the DM output window. For more information about user accounts and registries, see *Administering Your DOMAIN System*.

2. The system sets your initial working directory and naming directory to the log-in home directory designated in your user account. You can change your log-in home directory anytime you log in. (See the “Changing Your Home Directory” section later in this chapter.)
3. The DM (on nodes with displays) executes the node’s **log-in start-up script**, which resides in one of the files listed in Table 2-2. As shown in Table 2-2, the system chooses which log-in start-up file to execute according to the type of node you are using. Note that on DSPs, the SPM does not execute a log-in start-up file.

The DM looks for log-in start-up scripts in two different locations. First, it looks in *'NODE_DATA*, which refers to the node’s specific */SYS/NODE_DATA* directory. (By default, no log-in start-up script exists in *'NODE_DATA*; you must put one there.) If the DM doesn’t find the log-in start-up script in *'NODE_DATA*, it executes one of the default log-in start-up scripts that we supply in the directory */SYS/DM*.

Table 2-2. Node Log-In Start-Up Script Files

Node Type	Boot Script Filename
800x1024 (Portrait) DN400	STARTUP_LOGIN
1024x800 (Landscape) DN420, DN460, DN3xx, DN550, DN560, DN570, DN3000 (color)	STARTUP_LOGIN.19L
1280x1024 (Color Landscape) DN580	STARTUP_LOGIN.1280COLOR
1280x1024 (Black & White Landscape) DN3000 (Black & White)	STARTUP_LOGIN.1280BW
1024x1024 (Color) DN600	STARTUP_LOGIN.COLOR

You may want to create a log-in start-up script in `'NODE_DATA` in cases where you don't want the DM to execute the default version. For example, a diskless node, by default, uses one of the log-in start-up scripts located in its partner's `/SYS/DM` directory. If you want the diskless node to execute its own unique log-in start-up script, you can create a copy in the diskless node's `'NODE_DATA` directory. For more information about `'NODE_DATA` for diskless nodes, refer back to the "Diskless Node Start-Up" section.

The system uses log-in start-up scripts to start processes that you'll need while you are logged in to your node. For example, the log-in start-up scripts that we supply for nodes with displays create a process running the Shell program.

When you log out, the DM stops the Shell process and deletes its pads and windows from the display. Figure 2-6 shows a sample log-in start-up script that we supply for DN300 nodes.

```
# STARTUP LOGIN (the per_login startup file in
# 'node_data or /sys/dm)

# main shell whose shape is generally agreeable to
# users of this node

(0,300)dr; (700,700)cp /com/sh

## and the user's private dm command file from his
# home directory's user_data sub-directory. Personal
# key_defs file is also kept in user_data by DM.

# cmdf user_data/startup_dm.19L
```

*Figure 2-6. A Sample Log-In Start-Up Script
(STARTUP_LOGIN.19L)*

As shown in Figure 2-6, the command that creates the initial Shell process is the only command *not* commented out in the script. You may leave it in, comment it out by adding the pound sign character (#), or change it to draw the process's windows in a different location. You can also add commands that will start certain processes that you want to run each time you log in.

You'll notice that the last line in the sample script shown in Figure 2-6 contains the DM command **CMDF** (**COMMAND_FILE**). This command invokes another script, *STARTUP_DM.19L*. If you remove the # character from the command line, the DM attempts to execute this additional script as part of the log-in sequence. Otherwise, the system performs Step 5. (Note that when you remove the #,

the DM will not attempt to execute the script until the next time you log in.)

4. If no # character precedes the CMDF command line, the DM looks in the *USER_DATA* subdirectory of your log-in home directory for the specified file. If the DM finds the file, it executes the script; otherwise, it displays an error message in the DM output window when the log-in sequence completes.

This script, called the **DM start-up script**, is an optional script that you create to execute additional DM commands during log-in. For example, you may want to include commands that make specific key definitions or run specific programs. Figure 2-7 shows a sample DM start-up script.

Remember, we don't supply a DM start-up script as part of the system; if you want to use a DM start-up script, you must create one. If you do create a DM start-up script, remember to create a file that has the same filename as the file specified with the CMDF command. For example, the CMDF command in Figure 2-6, specifies the filename *STARTUP_DM.19L*. The suffix *19L* is the suffix for files used by nodes with landscape displays, like the DN300.

```

# USER_DATA/STARTUP_DM (in login home directory)
# Some personal preference keys:
#
# Define < F4 > and < F5 > for easy PASCAL
# indenting and unindenting:
#

KD F4 T1 ;S/% // KE
KD F5 T1 ;S/%/ / KE

#
# Define CTRL/J to repeat previous substitution:
#

KD ^J S KE

#
# Set tab every 5 spaces:
#

TS 5 - R

#
# Build a Shell window and execute a personal Shell
# program
#

(0,500)dr;(799,955) cp /com/sh -f -c 'user_data/sh'
(0,770)dr;(600,110) wdf1

```

*Figure 2-7. A Sample DM Start-Up Script
(STARTUP_DM.19L)*

5. The DM reads the file *KEY_DEFS3* (for nodes with DOMAIN Low-profile Model II keyboards), *KEY_DEFS2* (for DOMAIN Low-profile Model I keyboards) or *KEY_DEFS* (for nodes with 880 keyboards). These files, located in the *USER_DATA* directory of your log-in home directory, contain a record of any key definitions that you made the last time you were logged in. By reading these files, the DM carries over key definitions to the new log-in session. These files are non-ASCII files; therefore, you cannot edit them. The “Defining Keys” section in Chapter 3 describes the key definition files in more detail.
6. At this point, the log-in sequence is complete.

Logging In

Chapter 1 in *Getting Started With Your DOMAIN System* describes the basic procedure for logging in to your node. This section describes the various log-in procedures you can use to log in as **USER**, change your password and log-in home directory, and log in to a **DOMAIN Server Processor (DSP)**.

Logging In as User

The registry file *ACCOUNT*, described earlier in the “Understanding the System at Log-In” section, contains a default account named **USER.NONE.NONE**, or simply **USER**. This default account allows any user anywhere in the network to log into the **DOMAIN** system.

To use the default account, log in with the username *USER* as follows:

Please log in: USER <RETURN>

When the system prompts you for a password, simply press <RETURN>.

Changing Your Password

You can change your password anytime you log in by typing *-p* after your username as follows:

Please log in: L USERNAME -p <RETURN>

After you specify your current password at the “Password: “ prompt, the system displays the following prompt if the log-in is successful:

Enter new password:

Specify the new password next to the prompt, and press <RETURN>. Next the system prompts you to verify your new password (to ensure that you entered it correctly). At the prompt, type the new password again and press <RETURN>. Use the new password the next time you log in.

If you want to maintain a secure account, avoid using obvious passwords such as your username or your initials. If security is not a high priority, you can use a blank password. (Note, however, that blank passwords violate system security.) To change your password to a blank, specify a space in quotation marks. For example:

Enter new password: “ ” <RETURN>

To enter a blank password when you log in, just press <RETURN>.

Changing Your Home Directory

Each system account has a directory associated with it, called the **home directory**. Anytime you log in, the system sets your initial working and naming directories to your home directory. When you log in, you can change your home directory to another directory in the naming tree by specifying the *-h* option after your username as follows:

Please log in: L USERNAME -h

Specify your current password at the “Password: “prompt. If the log-in is successful, the system displays the following prompt along with the pathname of your current home directory:

Change home directory: *pathname*

To change your home directory, change the *pathname* to the pathname of the new home directory you want to use and press <RETURN>.

When you enter the pathname of your new home directory, the system attempts to update the file *ACCOUNT* in your site registry directory. This file contains information about your account, such as your username, password, and home directory. By updating the *ACCOUNT* file, the system stores your new home directory for logging in later. See *Administering Your DOMAIN System* for more information about the *ACCOUNT* file and system registries.

If the system succeeds in updating the *ACCOUNT* file, it displays a message in the DM output window verifying the update. If the system cannot update the *ACCOUNT* file, it displays a message in the DM output window. In the latter case, although the system could not

update the file, it still uses the new home directory during the current log-in session.

Logging Into a DOMAIN Server Processor (DSP)

Unlike user nodes, a DOMAIN Server Processor (DSP) doesn't have a keyboard or display. Therefore, you must log into it from a user node in the network.

As described earlier in the "Disked Node Start-Up" section, when you start up a DSP, the system starts a program called the Server Process Manager (SPM). The SPM makes it possible for you to create a process on the DSP, log into the process, and execute programs and commands, all while you sit at a user node in the network.

For a complete description of the procedure for logging into a DSP, see the *Owner's Guide* for your particular processor.

Using the Display Manager

The Display Manager (DM) is the operating system program that controls your node's display. Using DM commands, you can instruct the DM to perform specific display management operations, such as: moving the cursor around the display, creating and controlling processes, creating and manipulating pads and windows, and modifying display characteristics.

This chapter explains the functions of the DM and describes how to specify DM commands. It also describes how to define keys to perform DM operations. Chapter 4 describes how to use the DM to perform specific display-management tasks.

Using DM Commands

DM commands enable you to control your node's display by instructing the DM to perform specific display management operations. To use a DM command, you normally perform two basic steps:

1. Point to the spot on the display where you want the DM operation performed.
2. Specify a DM command to execute the operation.

You point to a spot on the display either by moving the cursor to the desired spot, or by explicitly defining a point on the screen as a command argument. If you don't perform a pointing operation using either method, the DM executes the command at the current cursor position.

Some DM commands require you to define an area, or **region**, on the screen instead of a single point. You define the size of a region by defining two points on the screen. The region is simply the area between the two points. The "Defining Points and Regions" section describes how to define points and regions.

To specify a DM command interactively:

1. Press **<CMD>** to move the cursor next to the *Command:* prompt in the DM input pad. (The DM remembers where the cursor came from so it can apply the next command to that point.)
2. Type the command along with any arguments or options.
3. Press **<RETURN>** to invoke the command.

Use this procedure to specify commands interactively from your keyboard. You can also specify commands in special DM programs, called **scripts**. When you invoke a DM script, the DM reads and executes DM commands in the order you specify them. The "Using DM Command Scripts" section describes how to use DM scripts.

The method you use to define a point depends on the DM command you use, and how you use it. When you specify a command interactively, you usually point with the cursor. In scripts, you specify a point explicitly as a command argument. Figure 3-1 illustrates the interactive procedure for invoking the WC command to delete a window.

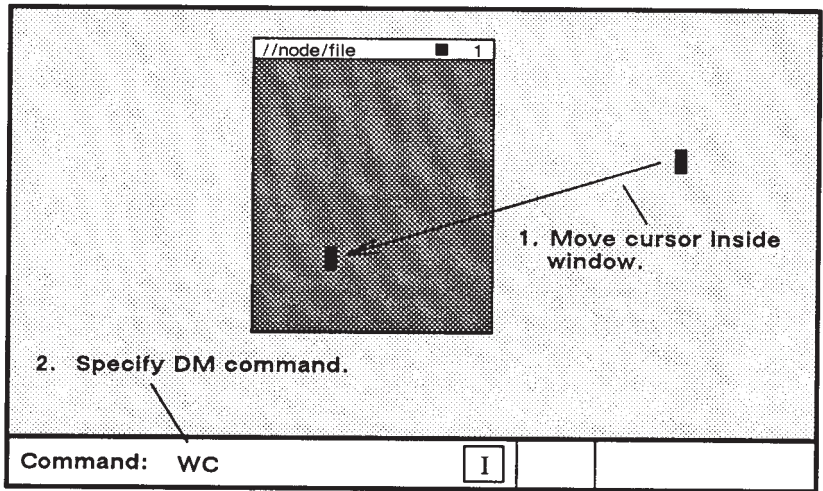

Figure 3-1. Invoking a DM Command Interactively

You can also invoke DM commands interactively using DM function keys and control key sequences. The “Using Keys to Perform DM Functions” section describes how to use these keys to perform DM functions.

DM Command Conventions

DM commands have the following general format:

[region] COMMAND [arguments ...] [options ...]

Separate the components of a command with the proper command line delimiters, as follows:

- Separate an argument from a command and any additional arguments or options with at least one blank space.
- Precede each option with a hyphen (-). Separate each option from commands, arguments, or any additional options with at least one blank space.
- If you precede the command with a region, make sure you use the correct syntax to define each point (see Table 3-2). You can place multiple blanks before and after the region, although they are not required.
- You can string multiple commands together on the same line by separating each command with a semicolon (;) as shown below:

PT;TT;TL

This command sequence executes three separate commands to move the cursor to the first character in a pad.

When you use commands in scripts and key definitions, you can use several special characters that control how the DM interprets commands. Table 3-1 lists the rules for using these special characters.

Table 3-1. Rules for Using DM Special Characters

-
- @ The **escape character** (@) always nullifies the meaning of any special character (such as the input request character) it precedes. When the DM reads a command line containing the escape character, it strips off the @ character, and any special meaning of the character following its.

If you can't remember whether a character has some special meaning, it is safe to escape the character. If the character is not special, the DM still removes the @, so the character appears as it should. Character escaping is generally confined to search and substitute operations (see Chapter 5), commands requiring quoted strings, and key definitions.

- # When the DM reads the **pound sign** (#) in a DM script, it ignores the information on the remainder of the line. Use this character to add comments to your DM script.
- ;
- Use the **semicolon** (;) to separate commands that you specify on the same line.
- & The **input request character** (&) enables you to supply keyboard input from the DM input pad to a command in a key definition or script. When the DM reads the &, it stops reading commands and moves the cursor to the DM input pad. When you enter input (usually a command argument), the DM replaces the & character with the specified input and continues reading commands. You can also specify a prompt in the form

& "prompt"

to display a prompt in the DM input pad that requests the proper input.

The following commands accept strings surrounded by single quotes: KD, ES, CP, CPO, CPS, and &. When you use single quotes, the only characters in the quoted string that retain their special meaning are @ and &; all other characters revert to their literal values. Note, however, that the KD command does not recognize single quotes within the definition string.

Defining Points and Regions

Most DM commands require you to either point with the cursor or define a point or region on the display. To point, simply move the cursor to the desired location. For example, to point to a window, position the cursor anywhere inside the window. Commands that operate on windows read the cursor position to determine which window you want to work on.

The block cursor actually occupies many individual screen points. When you use the block cursor to point to a spot on the screen, the lower left-hand corner of the block cursor designates the exact point. (When you point to the upper edge or right edge of a window, the DM adjusts the point position to account for the size of the cursor. See the “Creating Pads and Windows” section in Chapter 4 for more information on how the DM defines window boundaries.)

If you choose not to point with the cursor, you can explicitly define a point or pair of points (a region) using any of the point formats described in Table 3-2. Note that some formats define points in *pads*, and others define points on the *display* as a whole. You normally define points in pads when performing the pad editing operations described in Chapter 5.

Table 3-2. Formats for Specifying Points on the Display

line-number

Specifies a line location in a pad. Line numbers begin at 1 and range upward to the last line in the pad. To refer to the last line in a pad, you may specify the dollar sign (\$) symbol. The edit pad window legend displays the line number of the top line in a window. You can also display the line number (plus the column number, and x- and y- coordinates) of the current cursor position by using the DM command =.

+/- n

Specifies a line location in a pad that is *n* lines before (-) or after (+) the current cursor position.

[[line-number] [,column-number]]

Specifies a point in a pad by line and column number. The DM assumes the current line if you omit *line-number*; it assumes column 1 if you omit *column-number*. Line numbers range from 1 to the last line in the pad. Column numbers range from 1 to 256. Some examples are:

[127,14] Line 127, column 14.

[53] Line 53, column 1.

[,12] Column 12 of the current line.

Note that you must use the outer set of square brackets; however, when you specify *line-number* only, the brackets are optional. When using this format, you *cannot* use the dollar sign (\$) to specify the last line in a pad; you must specify the number of the last line.

/regular-expression/ or \regular-expression

Specifies a string in a pad that begins or ends a specific region. Chapter 5 describes regular expressions.

Table 3-2. *Formats for Specifying Points on the Display*
(continued)

([x-coordinate] [,y-coordinate])

Specifies a point on the display by screen coordinates. Screen coordinates indicate bit positions on the display. The origin (0,0) is at the extreme upper-left corner of the screen. Values for coordinates have the following ranges:

Display Type	x-coordinate	y-coordinate
1024x800	0 to 1023	0 to 799
1280x1024 (Landscape)	0 to 1023	0 to 1279
800x1024 (Portrait)	0 to 799	0 to 1023
1024x1024 (Square)	0 to 1023	0 to 1023

If you omit either coordinate from the specification, the DM uses the coordinates of the cursor. Note that you must enclose the coordinates in parentheses. Some examples are:

- (200,450)** Bit position with an x-coordinate of 200 and a y-coordinate of 450.
- (135)** Bit position with an x-coordinate of 135 and the same y-coordinate as the current cursor position.
- (,730)** Bit position with the same x-coordinate as the current cursor position, and a y-coordinate of 730.

When you specify any of the formats described in Table 3-2 in the DM input pad, the DM moves the cursor to the specified position. For example, to move the cursor to line 75, column 5 in an edit pad, specify the following in the DM input pad:

Command: [75,5]

You can also use any of the formats for defining points to define a region on the display. To define a region, you must define two points as follows:

[point] DR; [point]

The first point defines the beginning of the region and the *DR* command marks it. The second command defines the end of the region. When defining a two-dimensional region, the first point defines one corner, and the second point defines the opposite corner as shown in Figure 3-2.

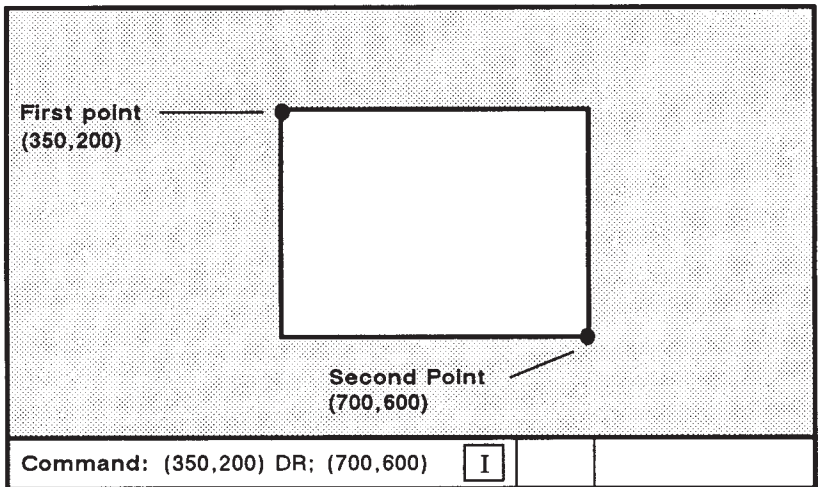

Figure 3-2. Defining a Display Region

When you define a region, if you don't specify a second position, the DM uses the current cursor position.

Like defining a single point, an easy way to define a region is to point with the cursor. For convenience, we defined the function key **<MARK>** to invoke the DR command, which marks the first point. To define a region using the cursor:

1. Move the cursor to the first point.
2. Press the **<MARK>** key.
3. Move the cursor to the second point.
4. Specify the DM command.

For a complete description of the DM commands used to control marks, see the *DOMAIN System Command Reference*.

For commands that require a region in which to operate, you have the option of specifying the region as part of the command. The **CV** (**CREATE_VIEW**) command, shown below, creates a read-only pad and window. It uses a region to define the size and location of the window it creates.

Command: (350,200) DR; (700,600) CV MY_FILE

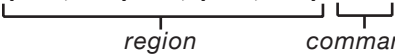

Using Keys to Perform DM Functions

You can also perform display management operations using keys, called **function keys**, that we've defined as specific DM commands. When you press a function key, it invokes its assigned DM command or command sequence.

By default, many keys perform DM operations when pressed simultaneously with the **<CTRL>** key. Like function keys, these key combinations, called **control key sequences**, provide you with a "shorthand" method of specifying commands.

The DOMAIN system's set of predefined function keys and control key sequences enable you to execute commonly performed opera-

tions. For example, the directional keys described in Chapter 1 in *Getting Started With Your DOMAIN System* are predefined keys that you'll use routinely to move the cursor.

We've also defined the mouse's function keys to perform three useful DM operations. Table 3-3 describes the default mouse key functions.

Table 3-3. Default Mouse Key Functions

Mouse Key	Function
Left Key (M1)	This key performs a GROW/MARK operation to change the size of windows. The section, "Changing Window Size" in Chapter 4 describes how to use the left mouse key to change the size of a window.
Center Key (M2)	This key works just like the <POP> key. To use it, move the cursor inside the window you want to pop, then press the key. See the section, "Pushing and Popping Windows" in Chapter 4 for more information.
Right Key (M3)	This key makes it easy for you to read files in your current working directory. It executes the CV (CREATE_VIEW) command with the name of the file you point to with the cursor. To use this key, specify the LD Shell command to list the contents of your current directory. Then, position the cursor over the name of the file you want to read and press the right mouse key.

Keyboard Types and Key Definitions

The DOMAIN System supports two basic types of keyboards:

- DOMAIN low-profile keyboards
- The 880 keyboard

DOMAIN low-profile type keyboards (shown in Figure 3-3) include the DOMAIN Low-profile Model I keyboard and the DOMAIN Low-profile Model II keyboard. Notice that the key layout for both of these keyboards is the same except that the Model II keyboard has a numeric keypad and two additional function keys, F0 and F9.

Note: The 880 keyboard is an older style keyboard that we no longer ship with new nodes. Appendix B describes the 880 keyboard and its predefined key functions. The command summary tables in this manual list the predefined function keys for the low-profile type keyboards only.

The system stores the definitions for its predefined keys in a keyboard-specific definition file. Table 3-4 lists the names of the definition file for each keyboard.

When you boot your node, the system loads the key definition file according to which KBD (KEYBOARD) commands are specified in your node's boot script (STARTUP) file. (See the "Understanding the System at Startup" section in Chapter 2 for a description of boot scripts.)

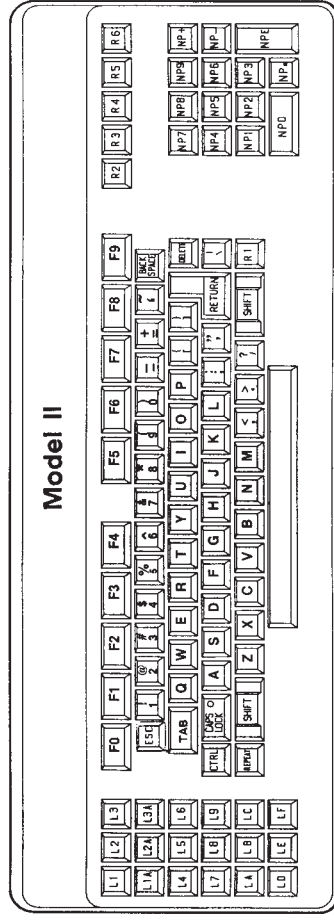
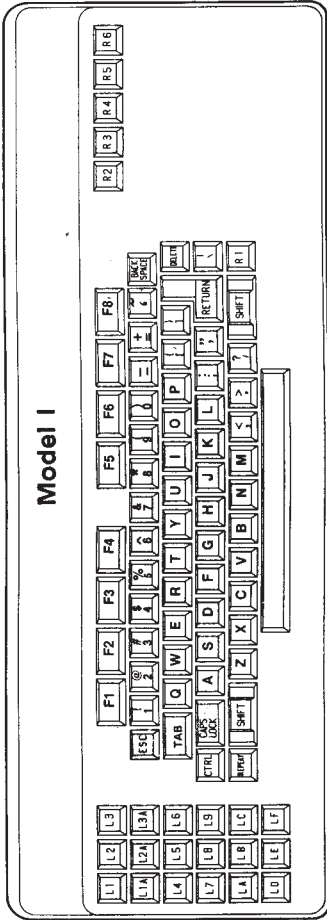

Figure 3-3. Key Names for the DOMAIN Low-Profile Keyboards

Table 3-4. Key Definition File Names

Keyboard	Key Definition File
880	/SYS/DM/STD_KEYS
Low-profile Model I	/SYS/DM/STD_KEYS2
Low-profile Model II	/SYS/DM/STD_KEYS3

To direct the DM to execute the *STD_KEYS2* file and establish key definitions for the low-profile Model I keyboard, remove the comment character (#) from the KBD 2 command. To use a node with the low-profile Model II keyboard, remove the comment character from the KBD 3 command. To use a node with an 880 keyboard, uncomment the command KBD.

After you log in, if you find that the predefined keys do not work as described in this manual, you can execute the appropriate *STD_KEYS(n)* file to set up the proper default key definitions for your keyboard. For example, to set up the predefined key definitions for the Model I keyboard, specify the following in the DM input pad:

Command: `C MDF /SYS/DM/STD_KEYS2`

You can also define your own function keys and control key sequences by assigning commands to specific key names. But, before you can define keys, you must understand how they are named. The next two sections describe key naming conventions and describe how to define keys.

Key Naming Conventions

The DM identifies each key on your keyboard (and mouse) by a unique name. The names of the ordinary character keys (letters and numbers) have the same name as the characters they represent. For example, the A key has the name “A”. Other keys, like the DM function keys, have special names that are different than the names written on them. The <READ> key, for example, has the name R2. Figure 3-3 shows the names and locations of the keys on both the low-profile type keyboards.

For example, the <CUT> / <COPY> function key (L1A) performs a different function when you use it with the <SHIFT> key. The name (L1A) identifies the key’s normal function (when you press the key down). The name (L1AS), referred to as the key’s *shifted* name, identifies the key’s function when pressed simultaneously with the <SHIFT> key. The key’s *up-transition* name (L1AU) identifies the function the key performs when released. Table 3-5 describes the key naming conventions you should use when defining keys.

When defining a key as a command or sequence of commands, you use the same name that the DM uses to identify the key. Some keys, like the DM and program function keys, function differently depending on how you use them. Therefore, each of these keys has a set of additional names that identify the manner in which the key is used.

Table 3-5. Key Naming Conventions

Key Type	Description														
Ordinary Characters	These keys have the same name as the characters (numbers and letters) they represent. You can assign functions to lowercase letters and numbers, as well as to capital letters and special characters. When you specify ordinary characters, enclose the character in single quotes (' ').														
ASCII Control	These are the standard line control keys. Their names are: <table data-bbox="489 576 909 958"><tbody><tr><td data-bbox="489 576 532 600">CR</td><td data-bbox="659 576 856 600">Carriage Return</td></tr><tr><td data-bbox="489 609 532 633">BS</td><td data-bbox="659 609 803 633">Back Space</td></tr><tr><td data-bbox="489 641 547 665">TAB</td><td data-bbox="659 641 707 665">Tab</td></tr><tr><td data-bbox="489 673 569 698">TABS</td><td data-bbox="659 673 803 698">Shifted Tab</td></tr><tr><td data-bbox="489 706 569 730">^TAB</td><td data-bbox="659 706 899 730">Control Shifted Tab</td></tr><tr><td data-bbox="489 738 547 763">ESC</td><td data-bbox="659 738 909 860">Escape (low-profile only). Same as '^[' (hex 1B)</td></tr><tr><td data-bbox="489 868 547 893">DEL</td><td data-bbox="659 868 909 958">Delete (low-profile only) Same as '^I' (hex 7F)</td></tr></tbody></table>	CR	Carriage Return	BS	Back Space	TAB	Tab	TABS	Shifted Tab	^TAB	Control Shifted Tab	ESC	Escape (low-profile only). Same as '^[' (hex 1B)	DEL	Delete (low-profile only) Same as '^I' (hex 7F)
CR	Carriage Return														
BS	Back Space														
TAB	Tab														
TABS	Shifted Tab														
^TAB	Control Shifted Tab														
ESC	Escape (low-profile only). Same as '^[' (hex 1B)														
DEL	Delete (low-profile only) Same as '^I' (hex 7F)														
Control Key	These are ordinary character or program function keys used with the <CTRL> key. Specify a control key name as ^x (where x is an ordinary character or program function key name.). For example, use ^Y for CTRL/Y or ^F4 for CTRL/F4.														
Program Function	These keys are reserved for user program control. They appear at the top of the keyboard and are named F1 through F8 as labeled. (For DOMAIN Low-profile Model II keyboards, these keys are named F0 through F9). Their up-transition names are F0U through F9U; their shifted names are F0S through F9S; and their control key names are ^F0 through ^F9.														

Table 3-5. Key Naming Conventions (continued)

Key Type	Description
DM Function	These keys are predefined to perform special display management functions. The function keys on the left side of the keyboard are named L 1 through LF. The function keys on the right are named R1 through R5. Specify a key's up-transition name by adding the suffix <i>U</i> to the key name. To specify a function key's shifted name (only on low-profile type keyboards), add the suffix <i>S</i> . For example, the up-transition name for R3 is R3U; the shifted name is R3S.
Numeric Keypad	These keys are only available on the DOMAIN Low-profile Model II keyboard. The keypad's numeric keys are named NP0 through NP9. The keypad symbols are named NP+, NP-, and NP, respectively. The "Enter" key is named NPE. Keys 0 through 9, plus (+), and minus (-) can have shifted names (for example, NP+S).
Mouse	These are located on the optional mouse and are named M1, M2, M3. Their up-transition names are M1U, M2U, M3U. These keys do not have shifted or control key names.

Defining Keys

As we described earlier, the DOMAIN system provides a set of default function keys and control key sequences defined as DM commands. You can override these definitions or create new ones in either of the following ways:

- Specify the **KD (KEY_DEFINITION)** command from the keyboard or in a script.
- Call the system routine **PAD_\$DEF_PFK** from a program.

When you define keys with the KD command during a session on your node, the DM writes the new definitions to one of the following files:

- **KEY_DEFS** for the 880 keyboard
- **KEY_DEFS2** for the DOMAIN Low-profile Model I keyboard
- **KEY_DEFS3** for the DOMAIN Low-profile Model II keyboard

These files reside in the *USER_DATA* subdirectory of your log-in home directory (see Chapter 2); they apply only to you, not to other node users. The DM checks these files whenever you log in, and sets your personal definitions to reset any of the standard key definitions set up by */SYS/DM/STD_KEYS(n)* (see Table 3-4).

Definitions made from within a program override those made by KD commands; however, they work only within the program's process window. Therefore, keys defined from a program may function differently in different windows. The "Controlling Keys from Within a Program" section describes how programs control key functions.

To define a key from the keyboard or from a script, specify the KD command in the following format:

KD key_name definition KE

In the KD command format, *key_name* specifies the unique name of the key you want to define. The previous section describes key

naming conventions, and Figure 3-3 shows the location and names of keys. Remember, always enclose ordinary character and special character names in single quotes. For example, to define the Z key, specify 'Z'.

The *definition* argument specifies either a single DM command or a sequence of DM commands that the desired key will perform. (The *DOMAIN System Command Reference* describes all of the DM commands you can use in key definitions.) When you specify a sequence of commands, either specify each command on a new line (in scripts) or separate each command with a semicolon (;). Always follow the definition argument with the *KE* argument, which signals the end of the KD command.

The command in the following example defines the program function key, F1, to move the cursor to the end of the previous line in a window:

```
KD F1 AU;TR KE
```

The diagram shows the command **KD F1 AU;TR KE** with three brackets underneath. The first bracket is under 'KD' and points to the label 'command'. The second bracket is under 'F1' and points to the label 'key_name'. The third bracket is under 'AU;TR KE' and points to the label 'definition'.

The definition argument in the example above specifies a command sequence composed of two commands: AU, which moves the cursor up to the previous line, and TR, which moves the cursor to the end of the line. You can specify any number of commands, but you cannot exceed 256 characters in the entire KD command.

You can embed key definitions inside other key definitions, and thereby define keys that define other keys. The embedded key definition follows the same rules as any other key definition; however, you must precede the semicolon (;) with an escape character (@) to separate the embedded KD command from the next command. The following example shows an embedded key definition:

```
KD F3 KD ^X ES 'THIS IS A TEST' KE@ ; PV KE
```

The diagram shows the command **KD F3 KD ^X ES 'THIS IS A TEST' KE@ ; PV KE**. A bracket underneath the sequence **KD ^X ES 'THIS IS A TEST' KE@** points to the label 'embedded key definition'.

This command defines the F3 key to perform the following operations when pressed:

- Define CTRL/X to print out the string, “This is a test.” (The embedded key definition specifies this function.)
- Invoke the PV command to scroll the current pad one line. (Chapter 4 describes the PV command.)

Note that the DM scans embedded key definitions three times when:

1. It makes the outer key definition.
2. It executes the outer key definition and makes the inner key definition.
3. It executes the inner key definition.

To define a key that prompts you for input, specify as part of the definition argument, the **input request character** (&) in the following format:

&”prompt”

where *prompt* specifies the prompt string. The input request character and prompt cause the DM to prompt for part of the definition argument you specified in the key definition. For example, the <READ> key (R3) has the following default key definition:

KD R3 CV &'Read File: ' KE

Whenever you press the <READ> key, the DM displays the prompt, *Read File:* in the DM input pad and moves the cursor next to it. When you respond to the prompt by typing the name of a file and pressing <RETURN>, the DM replaces &'Read File: from the key definition with your response. In this way, the CV command opens the file you specify. (Chapter 4 describes the CV command.)

NOTE: When you define keys in scripts, you must precede the input request character (&) with the escape character (@).

When you enter a response to a prompt, the DM remembers the response you typed. So, the next time you press the key, the DM

automatically displays the previous response next to the prompt. (This is why the <READ> and <EDIT> keys remember the last files used.) You can either move the cursor to the right of the previous response and press <RETURN> to enter the response, or delete the previous response and enter a new one.

Deleting Key Definitions

To delete a key definition, specify the KD command without a definition argument. For example:

```
KD F1 KE
```

deletes the current definition for the key named *F1*. For keys with ordinary character names, the key reverts to its normal graphic value.

Displaying Key Definitions

To display a key's current definition, specify the KD command without the definition or KE arguments. The command in the following example displays the definition for the <READ> key (R3):

```
KD R3
```

The DM displays the current key definition in the DM output window.

Controlling Keys from Within a Program

The DOMAIN system enables application programs to assume control of various display and keyboard functions. For example, the character font editor, **EDFONT** (**EDIT_FONT**), displays several different menus on your screen that you control with your mouse keys (M1 through M3). When you use EDFONT, the EDFONT program defines how these keys function; the keys do not maintain their normal DM definitions. The DM restores the mouse keys to their normal DM definitions when you end your EDFONT session. The *DOMAIN System Command Reference* describes the EDFONT character font editor.

For your own applications, you can control key definitions through program calls to the **PAD_\$DEF_PFK** and **PAD_\$DM_CMD** routines. For more information on these system routines, refer to the PAD routines section of the *DOMAIN System Call Reference*.

You may find the normal functions of the DM keys useful even when using an application program that has redefined them. With the **<HOLD>** key, you can temporarily override the application program's key definitions and use the normal DM definitions.

To override an application program's key definitions, press the **<HOLD>** key. By pressing the **<HOLD>** key again, you restore the application program's key definitions. Note that this function of the **<HOLD>** key is different than the normal DM function of switching a window in and out of hold mode (see Chapter 4).

Using DM Command Scripts

A **DM script** is a file that contains one or several DM commands. You can use DM scripts to perform any of the DM operations described in this manual, such as creating and controlling processes, manipulating pads and windows, editing files, and defining keys.

You execute scripts by specifying the pathname of the script file with the DM command **CMDF (COMMAND_FILE)** as follows:

CMDF pathname

The start-up scripts discussed in Chapter 2 are examples of DM command scripts that the system uses to set up your node's operating environment. In fact, your node's log-in start-up script uses the **CMDF (COMMAND_FILE)** command to invoke the DM start-up script that you create. Figure 2-2 in Chapter 2 shows a sample DM start-up script, *STARTUP.19L*, for a DN300 node.

Controlling the Display

This chapter describes how to use the DM to control your node's display. Each section describes a set of related screen-management tasks and the DM commands you use to perform them.

You can execute a DM command either from a DM script or interactively by specifying the command in the DM input window. In some cases, you can also execute a DM command by typing a function key or control key sequence.

The command summary tables, at the beginning of each section, list the DM commands, and related function keys and control key sequences, used to perform a specific set of tasks. Note that the predefined keys listed in these tables apply only to low-profile type keyboards. For a description of the predefined keys for the 880 keyboard, refer to Appendix B.

Chapter 3 explains how to specify DM commands from the keyboard and from scripts, and how to use function keys and control key sequences. For a complete description of all the DM commands described in this chapter, refer to the *DOMAIN System Command Reference*.

Controlling Cursor Movement



Moving the cursor is the most basic of all display management operations; it's also the one you'll perform most frequently. You use the cursor to move to a location on the display where you want to perform a specific operation. For example, you can move the cursor to point to the location where you want a DM command to operate, or you can move the cursor into the DM input window to type the name of a command.

In Chapter 1 of *Getting Started With Your DOMAIN System* you learned how to use the touchpad, mouse, and directional keys to move the cursor around the display. This section summarizes the DM commands and control key sequences used to control cursor movement. Table 4-1 lists the commands used to control the cursor. It also shows the predefined directional keys on low-profile type keyboards. Predefined keys for the 880 keyboard are described in Appendix B.

Table 4-1. Cursor Control Commands

Task	DM Command	Predefined Key
Move left one char.	AL	← (LA)
Move right one char.	AR	→ (LC)
Move up one line	AU	↑ (L8)
Move down one line	AD	↓ (LE)
Set arrow key scale factors	AS x y	None

Table 4-1. Cursor Control Commands (continued)

Task	DM Command	Predefined Key
Move to the beginning of line	TL	← (L4)
Move to end of line	TR	→ (L6)
Move to top line in window	TT	<SHIFT>  (LDS)
Move to bottom line in window	TB	<SHIFT>  (LFS)
Tab to window borders	TWB [l, r, t, b]	None
Move to the beginning of next line	AD;TL	CTRL/K
Tab left	THL	CTRL/<TAB>
Tab right	TH	<TAB>
Set tabs	TS [n1 n2 ...]	None
Move to DM input pad	TDM	<CMD> (L5)
Move to next window on screen	TN	<NEXT_WNDW> (L8)
Move to previous window	TLW	CTRL/L
Move to next window in which input is enabled	TI	None

NOTE: In this command summary table, the symbols enclosed in parentheses are the unique DM keynames. Refer to Chapter 3 for more information on key names and defining keys. This note applies to all command summary tables in this chapter.

Creating Processes

When you execute a program on a DOMAIN node, you run it in a computing environment called a **process**. Each process that you create is unique, providing a separate computing environment. Since the DOMAIN system enables you to create multiple processes on your node, you can run several programs simultaneously. You can create and run up to 24 simultaneous processes.

The system associates each process that you create with a **subject identifier (SID)**. The SID identifies the owner of a process and consists of the user's name, project, organization, and node ID. SIDs enable the system to control user access to processes and other objects on the system. Chapter 8 describes how the system uses SIDs and Access Control Lists (ACLs) to control access to system objects. By default, the system assigns the same SID to each process that you create.

You can create processes that have pads and windows that let you enter data and view program output. Or, you can create processes that run without the use of the display. The type of process you create depends on the program and its application.

To run an interactive program, for example, you create a process with pads and windows. The Shell program that we supply with your system is an interactive program. It prompts you for input (Shell commands) and displays output.

We also supply a set of special programs called **server programs** that provide you, or a program, with access to some service, such as the use of a peripheral device. Server programs run in processes called servers that you can create using any of the process creation commands described in this chapter. Many of these servers run as background processes *without* pads or windows.

Table 4-2 summarizes the commands used to create processes.

Table 4-2. Commands for Creating Processes

Task	DM Command	Predefined Key
Create new process, pads, and windows	CP pathname	<SHELL> (L5S)
Create new process without pads or windows	CPO pathname	None
Create a server process	CPS pathname	None

Creating a Process with Pads and Windows

To create a process with input and output pads and windows to view these pads, use the **CP** (**CREATE_PROCESS**) command in the following format:

[region] CP pathname [options]

where *region* specifies the coordinates of the process window and *pathname* specifies the pathname of the program you want the process to execute. The process pads and windows that the CP command creates enable you to supply input to programs and view program output.

The command in the following example creates a process that executes an interactive program called *COUNTER.BIN*. The program prompts for program input and displays its output to the process's transcript pad.

CP /HORACE/PROGS/COUNTER.BIN -N COUNTER

The *-N* option assigns the process the name *COUNTER*. When *COUNTER.BIN* completes (or if you stop the program or process),

the input and transcript pads close. To delete the remaining process window, type CTRL/N. Note that in this example, since no region is specified, the DM uses its default window coordinates to create the window (see the “Defining Default Window Positions” section later in this chapter.)

One process that you’ll create frequently is a process that runs the Shell program that we supply. You can create a process running “the Shell” by pressing the <SHELL> key or typing the CP command with the pathname /COM/SH as follows:

Command: CP /COM/SH

This command creates an input pad and a transcript pad, and opens the input pad as standard input. (Standard input is where, by default, a program gets user input.) In fact, the log-in start-up script, /SYS/DM/STARTUP_LOGIN executes this same command to set up the initial Shell process that you see when you log in. Figure 4-1 shows a process running the Shell.

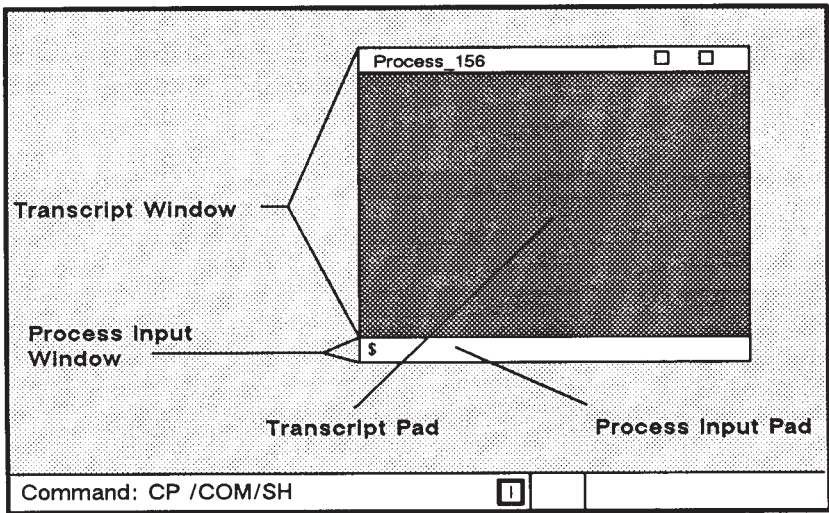

Figure 4-1. A Process Running the Shell

To stop both the Shell program and its process, type **CTRL/Z** (CTRL/Z signals the end of input) in the Shell's process input pad. Then, to close all the windows associated with the Shell's process, type **CTRL/N** or press **<ABORT>**. The "Controlling A Process" section describes how to stop programs and processes. The "Closing Pads and Windows" section describes how to close windows.

Creating a Process without Pads and Windows

To create a **background process** without associated pads and windows, specify the **CPO** (**CREATE_PROCESS_ONLY**) command in the following format:

CPO *pathname* [**options**]

where *pathname* specifies the pathname of the file that you want the process to execute.

When you invoke the CPO command, the system assigns the created process the SID of the process that invoked the CPO command. The created process runs until the owner of the process logs out.

Suppose you wanted to create a process running the alarm server program to monitor your disk usage, and to warn you when your disk becomes 90% full. To create the process and start the alarm server, specify the following command:

CPO /SYS/ALARM/ALARM_SERVER -DISK 90

In this example, the alarm server runs as a background process on your node. When you log off, the process stops. The manual, *Administering Your DOMAIN System* provides detailed information about the alarm server and other servers.

If you include the CPO command in the DM boot script, *'NODE_DATA/STARTUP* (see Chapter 2), the system assigns the created process the SID, *USER.SERVER.NONE.local_node*. In this case, the created process continues to run regardless of who logs in or out. You can perform this same function by executing the CPS command from the DM input window.

Creating a Server Process

You can create a server process without pads and windows that runs continually on your node by specifying the **CPS** (**CREATE_PROCESS_SERVER**) command in the following format:

```
CPS pathname [options]
```

where *pathname* specifies the pathname of the program you want the process to execute.

Use the CPS command when you want to create a server that runs regardless of whether anyone is logged in. For example, the following command starts the mailbox server **MBX_HELPER**:

```
CPS /SYS/MBX/MBX_HELPER -N MBX_HELPER
```

In the example above, the *-N* option assigns the process the name *MBX_HELPER*.

You usually invoke CPS commands from your node's boot script (*STARTUP*) during start-up. (Chapter 2 describes the boot script files the system uses when you start your node.) By including CPS commands in your node's boot script, you ensure that your servers restart whenever you have to restart your node. You can also invoke the CPS command from the DM input window.

Controlling a Process

Once you create a process, you can use the DM's process control commands to either stop it, suspend it, or restart it. Table 4-3 summarizes the DM commands used to control processes.

Table 4-3. Commands for Controlling a Process

Task	DM Command	Predefined Key
Quit, stop, or blast a process	DQ [-b -s -c nn]	CTRL/Q
Suspend execution of a process	DS	None
Resume execution of a suspended process	DC	None

Stopping a Program or Process

To stop a program or an entire process, use the **DQ** (**DEBUG_QUIT**) command in the following format:

DQ [options]

To stop a program, position the cursor inside the window of the process and either type **CTRL/Q** or specify the **DQ** command without any options. Either operation will generate a normal quit fault, which interrupts the execution of the current program and returns the process to the calling program (usually the Shell).

To stop an entire process, position the cursor inside the window of the process. Then, specify the following DM command:

DQ -S

This command stops the current process and closes any open streams, files, and pads. To delete the remaining window, move the cursor inside the window and type **CTRL/N**.

If you want to stop a Shell process, move the cursor to the Shell's process input window and type **CTRL/Z**. Typing **CTRL/Z** in the Shell's process input window signals the completion of input and

stops both the Shell and the process. You may find this method easier than using the DQ -S command.

Suspending and Resuming a Process

You can temporarily interrupt a process and then restart it using the DS (DEBUG_SUSPEND) and DC (DEBUG_CONTINUE) commands.

To interrupt a process, position the cursor inside the process window; then specify the DS command. Later, to restart the process, position the cursor inside the process window and specify the DC command.

Creating Pads and Windows

In order to read or edit a file, you must create a pad to hold it and a window to view it. Table 4-4 summarizes the DM commands used to create pads and windows for editing and reading files.

Table 4-4. Commands for Creating Pads and Windows

Task	DM Command	Predefined Key
Create an edit pad and window	CE pathname	<EDIT> (R4)
Create a read-only window	CV pathname	<READ> (R3)
Create a copy of an existing pad and window	CC	None

Before you can use the commands that create pads and windows, you should understand just how the DM determines what boundaries to assign to a new window.

When a window's size or position on the screen is changed in any way, the DM calculates the new boundaries of the window based on a pair of points on the screen called a **point pair**. (Usually, you define the first point in the pair with the DR command, and the second point by the current cursor position. You may also provide absolute point coordinates as described in the .. Defining Points and Regions" section in Chapter 3.)

Each point in a point pair may specify either a new or existing edge of a window, or a new or existing corner of a window. The DM creates a new window based on the relationship between the x- and y-coordinates of the two points.

The relationship between the two points in the point pair affects the actions of the DM window-creation commands, CP, CE, CV, CC, and the window-movement commands, WM, WME, WG, and WGE (see the "Managing Windows" section). Table 4-5 shows how the DM defines window boundaries according to the points given for window-creation and window-movement commands.

Table 4-5. DM Rules for Defining Window Boundaries

Points that have equal y-coordinates

- | | |
|---------------|---|
| Create | Create a window bounded by the given x-coordinates, the top of the display, and the DM command window. In other words, create a full vertical window. |
| Move | Select the unobscured vertical edge nearest to the first point and change the x-coordinate of that edge to that of the second point. |

Points that have equal x-coordinates

- | | |
|---------------|---|
| Create | Create a window bounded by the given y-coordinates and each side of the display. In other words, create a full horizontal window. |
| Move | Select the unobscured horizontal edge nearest to the first point, and change the y-coordinate of that edge to that of the second point. |
-

**Table 4-5. DM Rules for Defining Window Boundaries
(continued)**

Points that are equal

- | | |
|---------------|--|
| Create | Create a 512 by 512 window centered as nearly as possible to the given cursor position. |
| Move | Select the unobscured corner nearest the given point, and move the corner to that point. |

Points that differ in both x and y

- | | |
|---------------|--|
| Create | Each set of coordinates form opposing corners of the window. |
| Move | The first point selects the nearest unobscured corner (this corner must be visible) and the DM repositions the corner at the second point. |

**Only one point is given
(no DR is specified)**

- | | |
|---------------|---|
| Create | <p>The DM uses one of its five default window regions (see the “Defining Default Window Positions” section), or it determines the position by the last window creation or deletion command as follows:</p> <ul style="list-style-type: none">• If the last command was window deletion (WC), the default region is the same as that for the deleted window.• If the last command was a successful window-creation command, the default region is the next third of the screen• If the last command was an unsuccessful window-creation command, the default region is the same as that specified in the unsuccessful command. |
| Move | Grow is illegal and move behaves as if both points are equal. |
-

Creating an Edit Pad and Window

To create an edit pad and window, specify the **CE (CREATE_EDIT)** command in the following format:

[region] CE pathname

where *pathname* specifies the pathname of the file you want to edit. If the file you specify exists, the CE command opens the file for editing. If the file does not exist, the CE command creates a new file, assigns it the pathname you specified, and opens it for editing. Note that the CE command does not create a process; it opens a file for editing within the current DM process.

Once you create an edit pad, you can use the DM edit commands to manipulate the text that appears on the pad. Chapter 5 describes how to use the DM edit commands to edit pads.

As described in *Getting Started With Your DOMAIN System*, you can also create an edit pad and window using the **<EDIT>** key. When you press **<EDIT>**, an “Edit File: “ prompt appears in the DM input window, and the DM moves the cursor next to the prompt. To edit a specific file, type the file’s pathname next to the prompt, and press **<RETURN>** as shown in Figure 4-2.

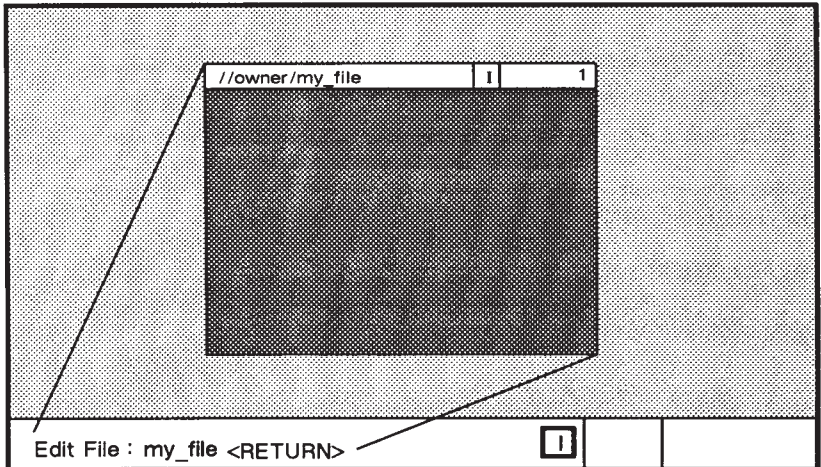

Figure 4-2. Creating an Edit Pad and Window

Creating a Read-Only Pad and Window

A read-only pad and window is identical to an edit pad and window with one exception: you cannot make changes to a read-only pad; you can only read it. (Note, however, that you can copy text from a read-only pad.)

To create a read-only pad and window, specify the **CV** (**CREATE_VIEW**) command in the following format:

[region] CV path name

where pathname specifies the pathname of the file you want to read. If the file you specify exists. The CV command opens the file and displays its contents. If the file does not exist, the DM displays the following error message:

(CV) filename - Name not found

Note that the CV command does not create a process; it opens a file for reading within the current DM process.

If the file you want to read is currently active in another window, you can create another new pad and window to read it. You cannot, however, edit a file while anyone else on the network has it open for editing.

On occasion, you may create a read-only pad and window and decide that you would like to make changes to the file. Instead of creating a new edit pad and window for the file, you can either type **CTRL/M** or specify the DM command, **RO** (set read/write mode), to change the read-only pad to an edit pad. Chapter 5 describes how to use the RO command to set a pad's read/write mode.

You can also create a read-only pad and window using the **<READ>** key. For a description of how to use the **<READ>** key, see *Getting Started With Your DOMAIN System*.

Copying a Pad and Window

With the **CC** (**CREATE_COPY**) command, you can create a copy of an existing pad and window and display it at a specific area on the screen. Figure 4-3 illustrates how to use the **CC** command to copy a pad and window.

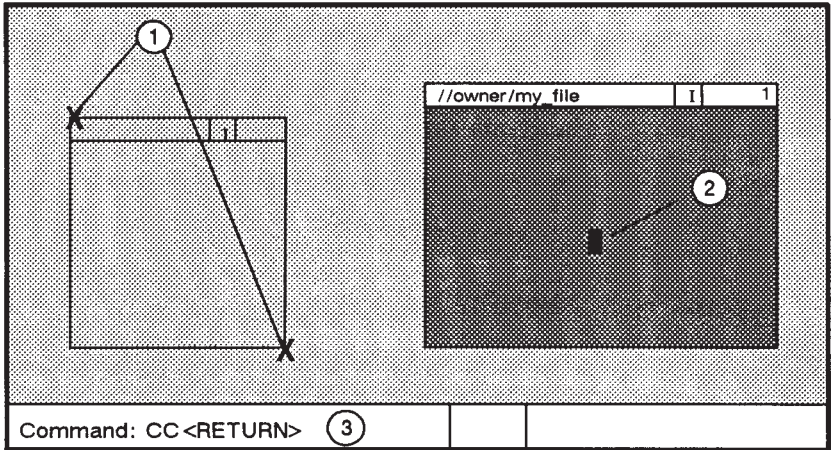

Figure 4-3. Copying a Pad and Window

The numbers in Figure 4-3 correspond to the following steps:

1. Mark opposite corners of the new window. To mark each corner: first move the cursor to the point on the screen where you want the corner to appear, then either press the **<MARK>** key or specify the **DR** command. (Chapter 3 describes how to use the **DR** command and **<MARK>** key to mark regions on the display.)
2. Move the cursor inside the window you want to copy.
3. Specify the **CC** command.

This procedure creates a copy of the pad and window and displays it at the location on the screen that you marked. If you issue the CC command without marking the display region, the DM determines the location according to the rules described earlier in the “Creating Pads and Windows” section.

Closing Pads and Windows

When you finish reading or editing a pad, you can close the pad and window using any of the commands listed in Table 4-6.

Table 4-6. Commands for Closing Pads and Windows

Task	DM Command	Predefined Key
Close window and pad; update file	PW; WC -Q	<EXIT> (R5)
Close window and pad; no update	WC -Q	<ABORT> (R5S)
Close (delete) a window	WC [-Q -F]	None

To delete (quit) a read-only or edit pad and associated windows, position the cursor inside the window and either press **<ABORT>** (on low-profile type keyboards only), type **CTRL/N**, or specify the following command:

WC -Q

The *-Q* option causes WC to delete the pad and window without saving the contents of the pad. If you modified the edit pad, you’ll

receive the following message in the DM input window asking you to confirm your request to quit:

File Modified. OK to quit?

If you respond by typing **Y** or **YES** followed by <RETURN>, the **WC** command deletes the pad and window without saving the contents of the pad. If you respond **N** or **NO**, the system ignores the quit request and returns the cursor to the edit pad.

If you modify an edit pad and want to save its contents (write its contents to a file), either press <**EXIT**> (for low-profile type keyboards only), type **CTRL/Y**, or specify the following command:

PW

The **PW** (**PAD_WRITE**) command copies the edited pad to a file that has the same name as the original file. The system saves the contents of the original pad in a file with the same name and the added suffix **.BAK**. Once you've saved the pad, use **WC** to close the edit window.

Managing Windows

Window control commands enable you to change the size, position, and characteristics of windows on the screen. You can use window control commands to manage edit pad windows, or process windows. Table 4-7 summarizes the window control commands.

Table 4-7. Commands for Managing Windows

Task	DM Command	Predefined Key
Changing window size	WG	CTRL/G
Changing window size with rubberbanding	WGE	<GROW> (LA3)
Move a window	WM	None
Move a window with rubberbanding	WME	<MOVE> (LA3S)
Set scroll mode	WS [-on -off]	CTRL/S
Set autohold mode	WA [-on -off]	None
Scroll and autohold mode	WA;WS	CTRL/A
Set hold mode	WH [-on -off]	<HOLD> (R6)
Define position of default window “n”	WDF [n]	None
Acknowledge alarm	AA	None
Acknowledge alarm and pop window	AP	None

Changing Window Size

Once you create a window on your screen, you can enlarge or shrink it with the **WGE (WINDOW_GROW_ECHO)** command.

As shown in Figure 4-4, the WGE command displays a flexible border, or **rubberband**, that changes as you move the cursor to enlarge or shrink the window. The position of the rubberband shows you the size and shape the window will become when you complete the operation.

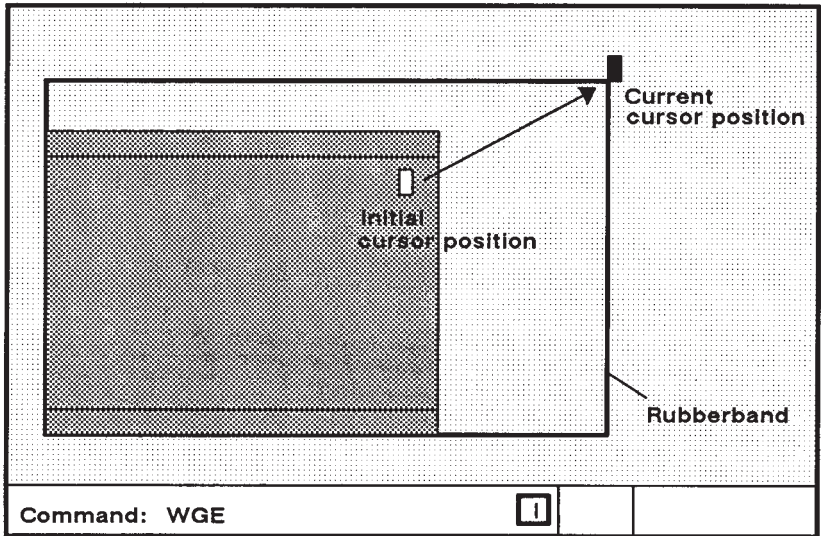

Figure 4-4. Growing a Window Using Rubberbanding

Use the following procedure to change the size of a window:

1. Move the cursor to the window corner or edge you want to move.
2. Press the **<GROW>** key or specify the **WGE** command. A rubberband border appears.
3. Move the cursor to stretch or shrink the rubberband until the rubberband matches the new size you want for the window.
4. Either press the **<MARK>** key or specify the **DR** command to complete the operation.

To cancel the procedure at any time, type **CTRL/X** or specify the **ABRT** command.

If you have a mouse, you can change the size of a window by using the left mouse key. To use the mouse to change the size of a window, perform the following procedure:

1. Move the cursor to the window corner or edge you want to move.
2. Press and hold the left mouse key. A rubberband border appears.
3. Holding the left key down, move the cursor to grow or shrink the window.
4. When the rubberband matches the new size you want for the window, release the left mouse key.

Moving a Window

To move a window to another location on the display, use the **WME** (**WINDOW_MOVE_ECHO**) command. The **WME** command, like the **WGE** command, uses a rubberband border to show you the exact position the new window will occupy.

1. Use the following procedure to move a window:
2. Move the cursor to any corner of the window you want to move.
3. Press the **<MOVE>** key or specify the **WME** command. A rubberband border appears.
4. Move the cursor until the rubberband is at the new window position.

Either press the **<MARK>** key or specify the **DR;ECHO** command sequence to complete the operation,

To cancel the procedure at any time, type **CTRL/X** or specify the **ABRT** command.

Pushing and Popping Windows

As you create multiple windows on your screen, you may begin to stack windows one on top of another. Some windows will partially obscure or completely hide others. To view hidden windows, use the **WP (WINDOW_POP)** command in the following format:

WP [options] [window_name]

The WP command either *pops* a window to the top of the stack or *pushes* a window to the bottom of the stack, depending on where you position the cursor. Figure 4-5 illustrates how to push and pop windows.

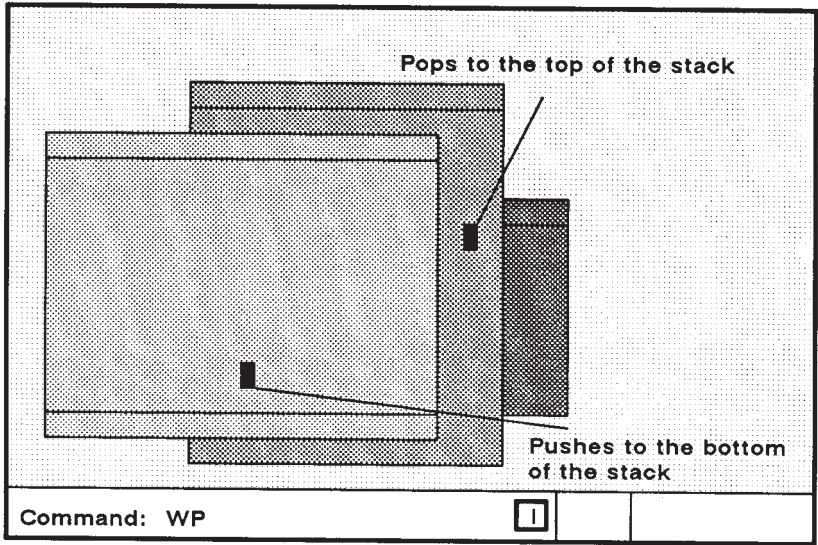

Figure 4-5. Pushing and Popping Windows

If you position the cursor in a partially obscured window, the WP command pops the window to the top of the stack. If you position the cursor in a completely visible window (the window on top), WP pushes the window to the bottom of the stack.

Use the following procedure to push or pop windows:

1. Position the cursor inside the window you want to push or pop.
2. Pop or push the window by either pressing the **<POP>** key (on low-profile type keyboards only), typing **CTRL/P**, or specifying the **WP** command.

You can also refer to a window you want to push or pop by specifying the name of the window. To specify a window name, either enter it as an argument to the **WP** command, or point to window name as follows:

1. Use the cursor to point to a text string that contains the name of the window you want to push or pop,
2. Press **<MARK>**, or specify **DR** to mark the window name.
3. Specify the **WP** command.

This second method is useful when you're displaying a list of all windows that you currently have open (see the description of the **CPB** command in the "Displaying the Members of a Window Group" section later in this chapter).

Changing Process Window Modes

The **DM** provides several modes that control how the **DM** inserts text into process input windows, and how process transcript windows display program output. Table 4-8 describes these modes.

You control window modes by positioning the cursor inside the process window and specifying window mode control commands. If you specify a command without any options, the command *toggles* the mode setting (turns it on or off depending on its current state).

Table 4-8. Process Window Modes

Mode	Description
Insert	Insert text in the input window rather than overstrike.
Scroll	Output scrolls one line at a time.
Hold	Content of the window does not change when the program sends output to the pad.
Autohold	Window automatically enters hold mode.

The window legend at the top of the process window displays a letter code that indicates which modes are on. Figure 4-6 shows the mode indicators and other components that make up the process window legend.

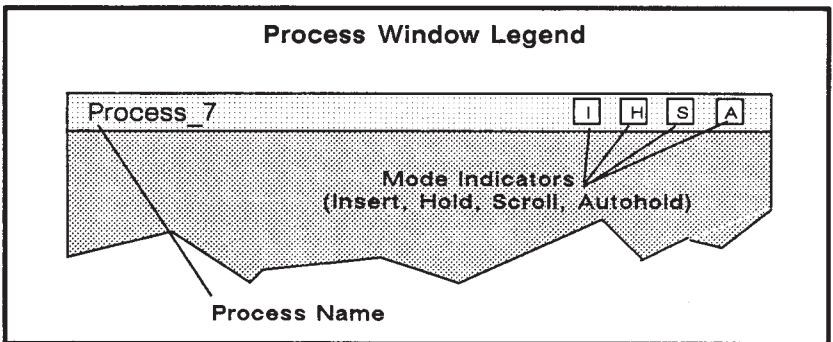

Figure 4-6. Process Window Legend

By default, the window legend displays the letter *I* indicating that the process input window is in **insert mode**. In insert mode, the DM inserts characters you type at the current cursor position. The remainder of the line moves to the right to make room for new characters.

With insert mode turned off, the process input window is in **overstrike mode**, in which characters you type replace those under the cursor.

To turn insert mode on or off, specify the **EI** command in the following format:

EI [-ON | -OFF]

If you do not specify an option, EI toggles the current mode.

To turn scroll mode on or off, specify the **WS (WINDOW_SCROLL)** command in the following format:

WS [-ON | -OFF]

With scroll mode turned on, the window displays output one line at a time as the transcript pad moves beneath the window. With scroll mode turned off, output does not appear a line at a time. Instead, when the program finishes sending output to the transcript pad, the window automatically displays the end of the pad and any new output.

Initially, all transcript pad windows have scroll mode turned on. The window legend at the top of the window displays the letter *S* when scroll mode is on. You can also toggle scroll mode on or off by typing **CTRL/S**.

To turn hold mode on or off, specify the **WH (WINDOW_HOLD)** command in the following format:

WH [-ON | -OFF]

When you turn hold mode on, the DM freezes the position of the transcript pad beneath the window. The window will not display new program output until you release the pad by turning hold mode off. When you turn hold mode off again, the window automatically displays the end of the transcript pad and any new program output.

Initially, all transcript pad windows have hold mode turned off. With hold mode turned off, the window automatically displays new output as the pad moves beneath it. The window legend displays the letter *H* when hold mode is on. You can also turn hold mode on or off by pressing the **<HOLD>** key.

To turn autohold mode on or off, specify the **WA (WINDOW_AUTOHOLD)** command in the following format:

WA [-ON | -OFF]

With autohold mode turned on, the window automatically turns hold mode on under either of the following conditions:

- A full window of output is available and none of it has been displayed.
- A form feed or create frame operation is output to the pad. In this case, the window displays the output preceding the form feed. When the window exits from hold mode, the output following the form feed or create frame operation starts at the top of the window.

To continue displaying output, turn hold mode off.

Initially, all transcript pad windows have auto hold mode turned off. The window legend contains an *A* when autohold mode is on. You can also turn autohold mode on or off by typing **CTRL/A** (which invokes the commands **WA;WS**).

Defining Default Window Positions

The DM uses default window positions to determine where to display the first five windows you create. To define any of the DM's five default window positions, specify the **WDF (WINDOW_DEFAULT)** command in the following format:

[region] WDF [n]

where *region* specifies the position that the window will occupy on the screen (see Table 4-5), and *n* specifies the identification number of the default window you are defining. If you omit *n*, the WDF com-

mand causes the DM to discard any current window information and begin creating windows using its default window boundaries.

The command in the following example defines the window position for default window four. Note the format of the region definition.

```
(0,770) DR; (600,110) WDF 4
```

region

If you want to use your own default positions for each log-in session, include WDF commands in your DM start-up script (*STARTUP_DM*). Once you've defined your default window positions, you should add the command WDF;CMS. This command instructs the DM to use the first WDF command to set up the default position for the first window you create. Otherwise, the DM uses the last WDF command in your script to determine the default position of the first window you create. For more information on DM start-up scripts, see "Understanding the System at Log-In" section in Chapter 2.

Responding to DM Alarms

Whenever the DM writes output to a partially obscured or hidden window, it sounds an alarm and displays a small pair of bells in the alarm window. (See Chapter 2 in *Getting Started With Your DOMAIN System* for a description of the DM alarm window.) To respond to an alarm, specify either the AA or AP commands.





The **AA** command acknowledges the DM alarm by turning off the current alarm and enabling further alarms (which may already be waiting).

The **AP** command acknowledges the DM alarm and pops to the top of the stack, the window to which the alarm pertains. This command is particularly useful when the window is completely hidden, and you can't point to it.

Moving Pads Under Windows

The DM pad control commands enable you to move a pad under a window. Table 4-9 summarizes the pad control commands.

Table 4-9. Commands for Moving Pads

Task	DM Command	Predefined Key
Move top of pad into window	PT	None
Move cursor to first character in pad	PT;TT;TL	CTRL/T
Move bottom of pad into window	PB	None
Move cursor to last character in pad	PB;TB;TR	CTRL/B
Move pad n pages	PP [-]n	  (LD, LF)
Move pad n lines	PV [-]n	<SHIFT> ↑ (L8S) <SHIFT> ↓ (LES)
Move pad n characters	PH [-]n	  (L7, L9)
Save transcript pad in a file	PN	None

Moving to the Top or Bottom of a Pad

Two DM commands enable you to move from the current position in a pad to the top or bottom of a pad. The **PT (PAD_TOP)** command moves the top line of a pad to the top of the current window. The

PB (PAD_BOTTOM) command moves the bottom line of a pad to the bottom of the current window. Neither command accepts arguments or options.

We also provide two predefined control key sequences that perform the same functions as the PT and PB commands; they also move the cursor to either the first or last character in the pad. To move the cursor to the first character in the pad, type **CTRL/T** (defined as the command sequence PT;TT;TL). To move the cursor to the last character in the pad, type **CTRL/B** (defined as the command sequence, PB;TB;TR).

Scrolling a Pad Vertically

You can scroll a pad up or down by a specified number of lines or pages using the vertical scroll commands or associated function keys. To scroll a pad by pages, specify the **PP (PAD_PAGE)** command in the following format:

PP [-]n

where n specifies the number (or fraction) of pages you want to scroll. A positive n (n) scrolls the pad up n pages; a negative n ($-n$) scrolls the pad down n pages. The DM considers a page the smaller of the following values:

- The number of lines that fit in a window.
- The number of lines between the bottom of the window and the next form feed or frame.

The command in the following example scrolls the pad down one and one-half pages:

PP -1.5

We also provide two predefined keys that scroll a pad either up or down one-half page at a time. Figure 4-7 shows the location of these keys.

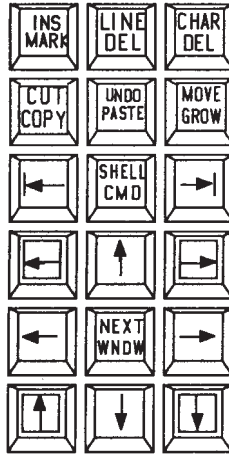

Figure 4-7. Location of Pad Scroll Keys

To scroll a pad by lines, specify the **PV** (**PAD_LINE**) command in the following format:

PV [-]n

where *n* specifies the number of lines you want to scroll. A positive *n* (*n*) scrolls the pad up *n* lines; a negative *n* (*-n*) scrolls the pad down *n* lines.

You can also use the two predefined function keys shown in Figure 4-7 to scroll a pad either up or down one line at a time. To scroll one line at a time, press **<SHIFT>** and the pad scroll key simultaneously.

Scrolling a Pad Horizontally

To scroll a pad horizontally by a specified number of characters, use the **PH (PAD_HORIZONTAL)** command or its associated function keys. The PH command has the following format:

PH [-]n

where *n* specifies the number of characters you want to scroll. A positive *n* (*n*) scrolls the pad to the left *n* characters; a negative *n* (*-n*) scrolls the pad to the right *n* characters.

You can also use two predefined function keys to scroll a pad either right or left 10 characters. Figure 4-7 shows the location of these keys.

Saving a Transcript Pad in a File

Normally, the DM deletes a transcript pad when you stop the pad's process and delete all windows. To keep a log of the current transcript pad and save the log in a file, specify the **PN (PAD_NAME)** command in the following format:

PN pathname

where *pathname* specifies the pathname of the file where the DM saves the contents of the pad. You must specify a pathname cataloged on your node; you can not use a pathname cataloged on another node.

The PN command stores the current transcript pad in a file that remains opened and locked until you stop the process and delete all windows. Once you specify the PN command, the DM saves all current and subsequent output written to the pad.

Using Window Groups and Window Icons

The DM provides several commands that enable you to create **window groups**, make these groups invisible, or use **icons** to represent them. Table 4-10 summarizes the commands used to control window groups and icons.

Table 4-10. Commands for Controlling Window Groups and Icons

Task	DM Command	Predefined Key
Create or add to a window group	WGRA grp-name [entry_name]	None
Remove a window from a window group	WGRR grp_name [entry-name]	None
Make windows invisible	WI [entry_name]	None
Change windows to icons	ICON [entry_name] [character]	None
Set icon positioning and offset	IDF	None
Display list of windows in group	CPB group_name	None

Creating and Adding to Window Groups

When you create a window group, you establish a group name and assign windows to the group. You can then make the window group invisible or represent the group with icons by specifying the group

name. Groups can contain individual windows, as well as other groups of windows.

To create a window group or add a window to an existing group, specify the **WGRA (WINDOW_GROUP_ADD)** command in the following format:

```
WGRA group_name [entry_name]
```

where *group_name* specifies the name of the group you want to create or add to, and *entry_name* specifies the name of the window or window group you want to add. For process windows, *entry_name* specifies the process name that appears in the window legend; for edit pad windows, *entry_name* specifies the pathname that appears in the window legend.

You must specify the *group_name* argument when you use this command. If you omit the *entry_name* argument, WGRA uses the name of the window where you last positioned the cursor.

The commands in the following example create a window group:

```
WGRA SHELL_WINDOWS PROCESS_1  
WGRA SHELL_WINDOWS PROCESS_2  
WGRA SHELL_WINDOWS PROCESS_3
```

The first command creates a window group named *SHELL_WINDOWS* and adds the window named *PROCESS_1* to the group. The remaining commands add additional windows (*PROCESS_2* and *PROCESS_3*) to the *SHELL_WINDOWS* group.

Removing Entries from Window Groups

To remove an entry (window or window group) from a window group, specify the **WGRR (WINDOW_GROUP_REMOVE)** command in the following format:

```
WGRR group_name [entry_name]
```

where *group_name* specifies the name of the group that contains the entry you want to remove, and *entry_name* specifies the window name or window group name you want to remove. You must specify the *group_name* argument when you use this command. If you omit

the *entry_name* argument, **WGRR** uses the pathname of the window where you last positioned the cursor.

The command in the following example removes a window named *PROCESS_1* from the group named *SHELL_WINDOWS*:

```
WGRR SHELL_WINDOWS PROCESS_1
```

Making Windows Invisible

To control whether a window or window group is visible or invisible, specify the **WI** (**WINDOW_INVISIBLE**) command in the following format:

```
WI [entry_name] [-W] [-I]
```

where *entry_name* specifies the name of the window or window group you want to make visible or invisible. If you omit the *entry_name* argument, **WI** uses the pathname of the window where you last positioned the cursor.

The *-W* option forces the window or group to appear as a window; the *-I* option forces the window or group to become invisible. If you specify the **WI** command without either of these options, **WI** *toggles* the setting (makes the window or group visible or invisible, whichever is the opposite of its current state).

The command in the following example makes the window group *SHELL_WINDOWS* invisible:

```
WI SHELL_WINDOWS -I
```

Using Icons

You use icons to represent a window or group of windows on your display. Because icons are small, they enable you to keep windows and window groups easily accessible without having them open on the display.

Icons are very similar to the windows they represent. For example, you can move icons with the **WME** command (see the “Moving a Window” section discussed earlier), or you can set the position on

the screen where icons will appear by default. You cannot, however, change the size of an icon on the display.

The DM displays an icon as a small window containing a specific icon symbol. The icon symbol describes the type of information the related window or group contains. Figure 4-8 shows the default icon for Shell process windows.

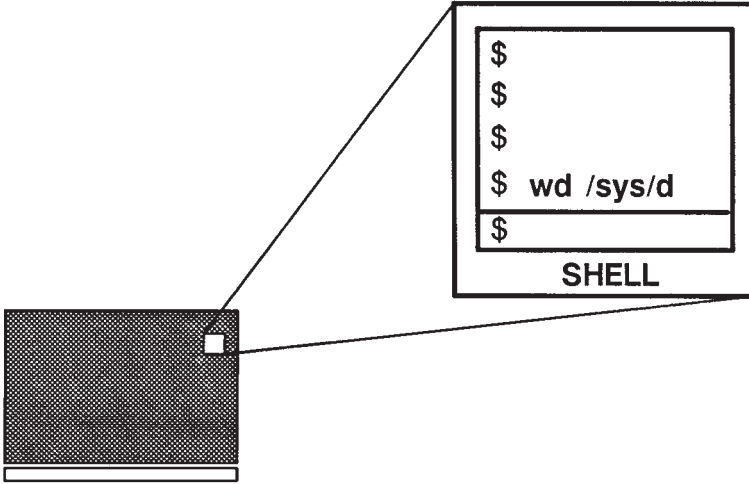

Figure 4-8. Default Icon for Shell Process Windows

To either change a window or window group into an icon, or to change an icon into the window or group it represents, specify the **ICON** command in the following format:

ICON [entry_name] [-I] [-W] [-C 'char']

where *entry_name* specifies the name of the window or window group you want to change into an icon, or change back into a window. If you specify the name of a window group as the entry name, the **ICON** command changes each window in the group. If you omit the *entry_name* argument, **ICON** uses the window where you last positioned the cursor.

The `-W` option forces the specified window or window group to appear as a window; the `-I` option forces the specified window or group to change to an icon. If you specify the `ICON` command without either of these options, `ICON` *toggles* the setting (changes the window or group to the opposite of its current state). The easiest way to change individual windows and icons is to position the cursor inside the window or icon and specify the `ICON` command.

The `ICON` command also accepts the `-C` option that allows you to specify which icon you want to use. Before we look at an example, let's look at how the system uses icons, and where it stores them.

The system uses certain default icons that we supply to represent specific types of windows. For example, whenever you change a Shell process window into an icon, the system, by default, uses the icon shown in Figure 4-8. Similarly, the system uses a special *EDIT* icon to represent read/edit windows. Many application programs that we supply also represent their specific process windows with their own specific default icons.

The system stores the default icons in a font file named `/SYS/DM/FONTS/ICONS`. (Note that this file is not an ASCII file; you cannot read it.) You can examine this file by using the **EDFONT** (**EDIT_FONT**) program described in the *DOMAIN System Command Reference*. You can also use `EDFONT` to create your own icons or change those the system uses by default.

Each icon in the font file *ICONS* is associated with a specific keyboard character. For example, the default Shell icon is associated with the lowercase “s” character. When you create an icon, you first choose a character, and then use `EDFONT` to transform the character into an icon symbol. (This is how we created the default icons that the system and various application programs use.) To use your own icon once you've created it, specify its associated character name with the `-C` option.

The `-C` option allows you to specify the character associated with the icon you want to use. For example, suppose you used `EDFONT` to create your own icon associated with the uppercase “F” character in the *ICONS* file. To use this icon to represent the read/edit window `JUNE_REPORT`, use the following command:

```
ICON JUNE_REPORT -I -C F
```

In this example, the `ICON` command directs the DM to change the read/edit window `JUNE_REPORT` into an icon. Normally, the DM uses the default icon for read/edit windows. The `-C` option directs the DM to use the icon associated with the character `F` in `/SYS/DM/FONTS/ICONS` instead of the default read/edit icon.

Setting Icon Default Position and Offset

The DM allows you to set the position of an icon on your screen and specify an **offset** that the DM uses to determine the positions of the next icons you create. The offset value specifies the position of new windows relative to the position of the previous icon.

By default, the DM displays icons in a horizontal line across the top of portrait displays, and in a vertical line along the right side of landscape displays. The default offset is the width of one icon (60 bits); horizontally for portrait displays, vertically for landscape displays.

With the **IDF (ICON_DEFAULT)** command, you can change the default positioning and offset of an icon, or to establish the position of an icon you create in a script. You can use the IDF command in any of the following ways:

- Move the cursor to the desired default icon position. Press the **<MARK>** key or specify the **DR** command to mark the position. Specify the **IDF** command to set the new position. Since you did not specify an offset value, the DM places any new icons that you create at this one position.
- Move the cursor to the desired default icon position. Press the **<MARK>** key or specify the **DR** command to mark the position. Move the cursor to indicate the offset vector for the next icon. Specify the **IDF** command to set the new position and offset.
- Specify the icon position and offset explicitly in the following command line format:

(position) DR; (offset) IDF

where *position* specifies the x- and y-coordinates of the icon position and *offset* specifies the coordinates of the offset vec-

tor. For example, the following command line sets an icon position and offset:

```
(800,10) DR; (850,60) IDF
```

This command sets the position for the first icon at bit position (800,10). The next icon will appear at bit position (850,60), an offset of (50,50) from the original position. Refer to the “Defining Points and Regions” section in Chapter 3 for more information.

Displaying the Members of a Window Group

To display a list of windows in a specific group, use the **CPB (COPY_PASTE_BUFFER)** command in the following format:

```
CPB group_name
```

where *group_name* specifies the name of the window group you want to list. The *group_name* refers to a paste buffer that contains the names of the windows in the group. The CPB command creates a window to the paste buffer you specify as the *group_name* and displays the paste buffer’s contents. For example:

```
CPB MY_GROUP
```

This command displays the names of all the windows in the window group *MY_GROUP*. A paste buffer named *MY_GROUP* contains these window names.

The DM automatically creates three special paste buffers to help you manage your windows and icons. Table 4-11 describes these paste buffers.

To list the contents of one of these special paste buffers, specify the CPB command with the special *group_name* as follows:

This command opens the paste buffer *INVIS_GROUP* that contains the names of all the windows you’ve made invisible.

Table 4-11. Window Paste Buffers

Mode	Description
INVIS_GROUP	Contains the pathnames of all the windows that you've made invisible.
ICON_GROUP	Contains the pathnames of all the windows represented by icons.
ALL_GROUP	Contains the pathname of every window open on your node, including: Shell process windows, DM windows, visible and invisible windows, and windows represented by icons.

Editing a Pad

Chapter 4 describes how to create pads and windows to read and edit files. This chapter describes how to use the DM to control the characteristics of edit pads, and how to edit text.

Each section in this chapter describes a set of editing tasks and the DM commands you use to perform them. You can execute a DM command either from a DM script or interactively by specifying the command in the DM input window. In many cases, you can execute a DM editing command by typing a function key or control key sequence.

The command summary tables at the beginning of each section list the DM commands, related function keys, and control key sequences used to perform a specific set of editing tasks. Note that the predefined keys listed in these tables apply only to low-profile type

keyboards. For a description of the predefined keys for the 880 keyboard, refer to Appendix B.

Chapter 3 explains how to specify DM commands from the keyboard and from scripts, and how to use function keys and control key sequences. For a complete description of all the DM editing commands described in this chapter, refer to the *DOMAIN System Command Reference*.

Setting Edit Pad Modes

All edit pads are controlled by a very important feature of the DM: the **modes** in which the DM currently operates. The modes determine whether you can make changes to the material in the pad, and whether the DM either inserts characters that you type or overstrikes them. Table 5-1 summarizes the DM commands used to change edit pad modes.

Table 5-1. Commands for Setting Edit Modes

Task	DM Command	Predefined Key
Set read/write mode	RO [-ON -OFF]	CTRL/M
Set insert/overstrike mode	EI [-ON -OFF]	<INS> (LIS)

Figure 5-1 shows the window legend for edit pads. The edit pad window legend provides information about a window's characteristics, such as the pathname of the file and current window modes. The edit pad window legend also displays the **line number** of the line at the top of the window and the **horizontal offset**, which indicates the number of columns the window has been scrolled sideways over the pad. The horizontal offset number appears only when you scroll the window sideways over the pad.

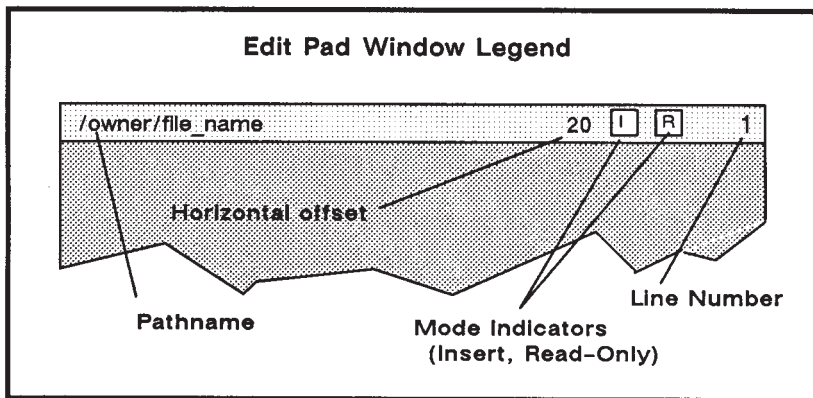

Figure 5-1. The Edit Pad Window Legend

Setting Read/Write Mode

Edit pads can be in **read-only** mode or **write mode**. In read-only mode, you cannot write to or make changes to the text in a pad. However, you can copy, search for, and scroll the text. In write mode, you can write to a pad and change text using all of the editing commands described in this chapter.

When a pad is in read-only mode, the letter **R** appears in the window legend as shown in Figure 5-1. The **R** disappears in write mode.

To turn read-only mode either on or off, specify the **RO** command in the following format:

RO [-ON | -OFF]

The **-ON** option instructs **RO** to set the pad to read-only mode. The **-OFF** option causes **RO** to set the pad to write mode (i.e., it turns read-only mode off). If you do not specify an option, the **RO** command toggles the current mode setting.

You can also toggle the current setting by typing **CTRL/M**. The **CTRL/M** sequence invokes the **RO** command without options.

If you've modified the text in a pad, you cannot change the pad to read-only mode without first writing the changes to a disk file (saving

the file). The PW command, described in the “Updating an Edit File” section, allows you to write your changes to a disk file without closing the pad and window.

Setting Insert/Overstrike Mode

The DM has two modes to control how text is added to a pad: **insert mode** or **overstrike mode**. In insert mode, the DM inserts characters you type at the current cursor position. The remainder of the line moves right to make room for the new characters.

In overstrike mode, characters you type replace, or “overstrike,” those under the cursor. Overstrike mode is useful when you want to enter text into a pre formatted file without disrupting the file’s format.

When a pad is in insert mode, the letter **I** appears in the window legend as shown in Figure 5-1. The I disappears in overstrike mode. All pads are initially in insert mode, although this is irrelevant if the pad is also read-only.

To turn insert mode either on or off, specify the **EI** command in the following format:

EI [-ON | -OFF]

The *-ON* option instructs EI to set the current pad to insert mode. The *-OFF* option causes EI to set the pad to overstrike mode (i.e., it turns insert mode off). If you do not specify an option, the EI command toggles the current mode.

You can also toggle the current mode by pressing **<INS>**. This key invokes the EI command without options.

Inserting Characters

Any pad that is in write mode automatically accepts anything that you type at the keyboard as input to that pad. The commands listed in Table 5-2 perform special insertion functions.

Table 5-2. Commands for Inserting Characters

Task	DM Command	Predefined Key
Insert string at cursor	ES 'string'	<i>Default DM operation</i>
Insert NEWLINE character	EN	<RETURN>
Insert a new line after current line	TR;EN;TL	<F1>
Insert raw (no echo) character	ER nn	None
Insert end-of-file mark	EEF	CTRL/Z

Inserting a Text String

When a pad is in write mode, the DM inserts any text character you type at the current cursor position. This is the default Display Manager action. If you try to type text into a read-only pad, the DM displays an error message in the DM output window.

To insert a text string at the current cursor position, specify the **ES** command in the following format:

ES 'string'

The *'string'* argument is the text that you want to insert. Enclose the text in single quotes ('').

The ES command inserts a string of text at the current cursor position. Since text insertion is the default action, you'll probably find this command most useful in key definition commands where you want some text written out when the key is pressed. Chapter 3 describes how to define keys to perform DM functions.

Inserting a NEWLINE Character

The NEWLINE character marks the end of the line.

To insert a NEWLINE character at the current cursor position, either press **<RETURN>** or specify the **EN** command. When you insert a NEWLINE character, the cursor moves to the beginning of the next line.

Inserting a New Line

To insert a new, blank line following the current line, specify the following command sequence:

TR;EN;TL

The **TR** command moves the cursor to the end of the line, **EN** inserts (or overstrikes) a NEWLINE character, and **TL** moves the cursor to the beginning of the next line.

By default, the **<F1>** key invokes the TR;EN;TL command sequence.

Inserting an End-of-File Mark

To insert an end-of-file mark (EOF) in a pad, type **CTRL/Z** or specify the **EEF** command. If the line containing the cursor is empty, the DM inserts the end-of-file mark on that line. Otherwise, the DM inserts the end-of-file mark following the current line.

It is a common (although not universal) convention for programs to terminate execution and return to the process that called them when they receive an end-of-file mark on their standard input stream.

The Shell is such a program. When the top-level program in a process (usually /COM/SH) returns, the process stops and all of its streams are closed. The DM then closes and deletes the Shell's process input pad and window, and closes the transcript pad.

Whether or not the DM also deletes the transcript window depends on the setting of its auto-close mode. If auto-close mode is disabled (the default setting), then you must manually delete any windows as-

sociated with the closed transcript pad by using the DM command WC -Q, or CTRL/N. The “Closing Pads and Windows” section in Chapter 4 describes the WC -Q command and CTRL/N. See the WC command description in the *DOMAIN System Command Reference* for more information about auto-close mode.

Deleting Text

The commands listed in Table 5-3 delete characters, words, or lines of text. To delete a larger block of text, refer to the “Cutting Text” section.

Table 5-3. Commands for Deleting Text

Task	DM Command	Predefined Key
Delete character at cursor	ED	<CHAR DEL> (L3)
Delete character before cursor	EE	<BACK SPACE> (BS)
Delete “word” of text	DR;/[~A-Z0-9\$_]/XD	<F6>
Delete from cursor to end of line	ES “;EE;DR;TR; XD;TL;TR	<F7>
Delete entire line	CMS;TL;XD	<LINE DEL> (L2)

Deleting Characters

To delete the character under the cursor, press <CHAR DEL> or specify the **ED** command. If the character under the cursor is a NEWLINE, ED joins the current line and the following line.

To delete the character to the left of the cursor, press **<BACK SPACE>** or specify the **EE** command. If the pad is in overstrike mode, the **EE** command replaces the character with a blank.

Both **<CHAR DEL>** and **<BACK SPACE>** are repeat keys. You can repeat the operation by holding down the key.

Deleting Words

To delete a word of text at the current cursor position, press the predefined function key **<F6>**. In this case, a “word” consists of a string of characters that may include a tilde (~) in the first position of the word, upper or lowercase letters, numbers, dollar signs (\$), or underscores (_). The deletion stops at the next space, punctuation mark, or special character (other than a dollar sign or underscore). Here are some examples of character strings that **<F6>** will delete: *\$FILE*, *my_file3*, *~REPORT*.

The **<F6>** function key invokes the command sequence **DR;[~A-Z0-9\$_]/XD**.

The DM writes the deleted word to its default paste buffer (a temporary file). You can reinsert the word elsewhere by moving the cursor to the desired location and either pressing **<PASTE>** or specifying the **XP** command. For more information about paste buffers and the **XP** command, see the “Copying, Cutting, and Pasting Text” section.

Deleting Lines

To delete text from the current cursor position to the end of the line (excluding the **NEWLINE** character), press the predefined function key **<F7>**. The **<F7>** key invokes the following command sequence:

ES ‘ ’;EE;DR;TR;XD;TL;TR

The DM writes the deleted line to its default paste buffer. You can reinsert the line elsewhere by either pressing **<PASTE>** or specifying the **XP** command. For more information about paste buffers and the **XP** command, see the “Copying, Cutting, and Pasting Text” section.

Defining a Range of Text

The editing commands that perform cut (delete), copy, and substitute functions operate on a range, or block, of text. You mark a range of text just as you would mark any other region in a pad (see the “Defining Points and Regions” section in Chapter 4). However, you may not declare a range as an argument to an editing command. You must use the DR command or the <MARK> key before specifying the editing command.

To use the **DR** command to define a range of text, define two points as follows:

[point] DR; [point]

The first *point* defines the beginning of the range, and the DR command marks it. The second *point* defines the end of the range. If you do not specify literal points, DR places the marks at the current cursor position.

An easy way to define a range of text is to point with the cursor and use the <MARK> key. The <MARK> key invokes the DR and ECHO commands, which mark the first point and begin highlighting the text. Figure 5-2 illustrates how the DM highlights the text as you move the cursor to the end of the range.

To define a range of text using the cursor and <MARK>, follow this procedure:

1. Move the cursor to the first point (the beginning of the range of text).
2. Press <MARK>.
3. Move the cursor to the second point (the end of the range).
4. Specify the appropriate DM editing command.

Please note that the character under the cursor at the end of the range is not included within the range.

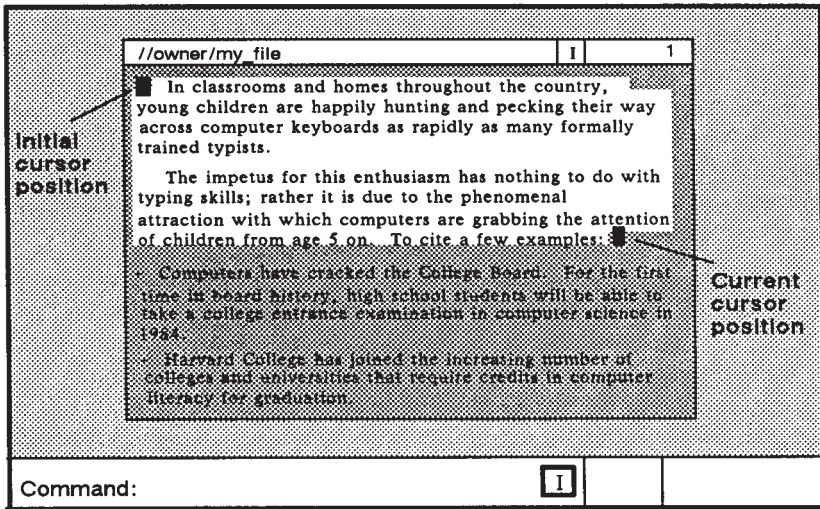

Figure 5-2. Defining a Range of Text with <MARK>

Copying, Cutting, and Pasting Text

The commands listed in Table 5-4 copy, cut, and paste a range of text. They allow you to move blocks of text from one place to another in a pad (or between pads).

Before specifying the commands that copy or cut text, use the DR command or <MARK> to define the range of text to be copied or cut (see the previous section). If you do not define a range, the DM copies or cuts the text from the current cursor position to the end of the line.

Table 5-4. Commands for Copying, Cutting, and Pasting Text

Task	DM Command	Predefined Key
Copy text to a paste buffer or file	XC [name -f pathname] [-R]	<COPY> (L1A)
Cut (delete) text and write it to a paste buffer or file	XD [name -f pathname] [-R]	<CUT> (L1AS)
Paste (write) text from a paste buffer or file into a pad	XP [name -f pathname] [-R]	<PASTE> (L2A)

Using Paste Buffers

To perform copy, cut, and paste operations, the DM uses temporary files called **paste buffers**. Paste buffers hold text you've copied or cut so that you can paste it in elsewhere.

You can create up to 100 paste buffers, each containing different blocks of text. To create a paste buffer, you specify a name for the paste buffer as an argument to the commands that copy or cut text (XC and XD). To insert the contents of a paste buffer you have created, specify the name of the paste buffer as an argument to the command that pastes text (XP). We describe the XC, XD, and XP commands in the next three sections.

When you log off, the DM deletes all paste buffers you have created during the session. If you want to save the copied or cut text for use during another session, you can write it to a permanent file (see the XC and XD command descriptions in the next two sections).

If you do not specify the name of a paste buffer or permanent file when you specify the commands that copy or cut text, the DM writes the text to its **default (unnamed) paste buffer**. The DM also uses this default paste buffer when you press the predefined function keys and control key sequences that copy, delete, and paste text.

NOTE: In a paste buffer, the DM saves only the text copied or deleted during the last DM operation. Therefore, do not write *anything* else to the paste buffer until you have reinserted its contents. Otherwise, you will lose the text you're attempting to move.

Copying Text

To copy a defined range of text from any pad into a paste buffer or file, specify the **XC** command in the following format:

XC [name | -f path name] [-R]

where *name* specifies the name of a paste buffer that the DM creates to hold the copied text. The *-f pathname* option specifies the name of a permanent file for the text. For example:

XC copy_text

copies a defined range of text into a paste buffer named *copy_text*. Here is another example:

XC -f copy_text

copies a defined range of text into a permanent file named *copy_text*.

If you supply the name of an existing paste buffer or file, **XC** overwrites its contents with the newly copied text. If you omit the name of a paste buffer or permanent file, **XC** writes the copied text to the default (unnamed) paste buffer.

The *-R* option instructs **XC** to copy a rectangular block of text that you have defined by marking the upper left and lower right corners of a text region. To define the region, use the cursor and the **DR** command or **<MARK>** to specify the left corner, then move the cursor to specify the right corner. If you specify a column (the left and right corners in the same column), **XC** copies all characters to the right of the column.

Figure 5-3 shows the two cursor positions used to mark the column. The dotted rectangle shows the block of text that the **XC -R** com-

mand copies. (The dotted rectangle is only for the purpose of illustration; it does not appear on your display.)

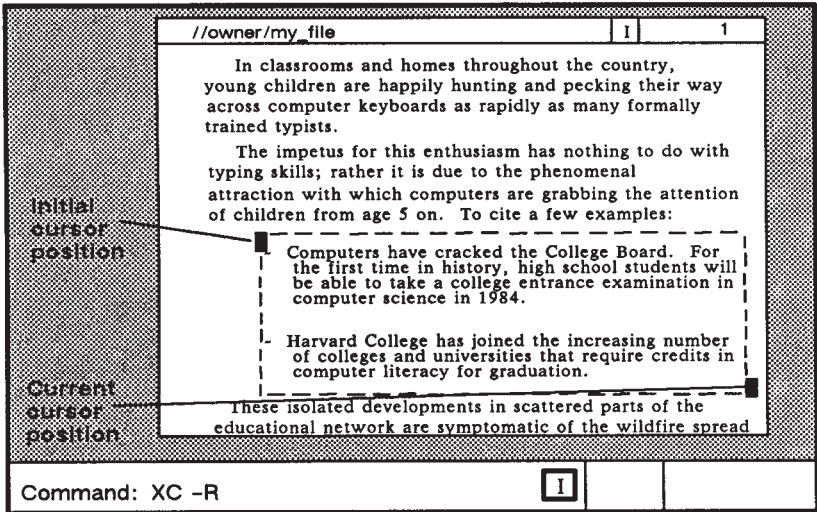

Figure 5-3. Copying Text with the XC -R Command

By default, the `<COPY>` key invokes the XC command using the default (unnamed) paste buffer. You must specify the XC command with the *name* argument or the `-f pathname` option if you want to copy text to a named paste buffer or permanent file.

Once you have copied a range of text, you can use the XP command to paste the text in elsewhere (see the “Pasting Text” section).

Copying a Display Image

To copy a display image into a graphics map file (GMF), use the XI command in the following format:

```
XI [-F pathname]
```

where `-F pathname` specifies the name of the file you want to store the display image. If you omit the `-F` option, the system writes the image to `'NODE_DATA/PASTE_BUFFERS/DEFAULT.GMF'`.

Once you copy the image to a file, you can print the file using the PRF command with the *-PLOT* option as follows:

```
PRF MY_FILE.GMF -PLOT
```

To use the XI command, mark the range of the display you want to copy. If you do not specify a range, XI copies the entire window in which the cursor is positioned. Note that if you want to copy the whole screen, use the Shell command **CPSCR (COPY_SCREEN)**. Chapter 7 describes the CPSCR command.

Cutting Text

When you cut text from a pad, the DM copies the text into a paste buffer or file and then deletes it from the pad. To cut a defined range of text, specify the **XD** command in the following format:

```
XD [name | -f pathname] [-R]
```

where *name* specifies the name of a paste buffer that the DM creates to hold the deleted text. The *-f pathname* option specifies the name of a permanent file for the text. You can use this command only in pads created with <EDIT> or the CE command.

If you supply the name of an existing paste buffer or file, XD overwrites its contents with the newly deleted text. If you omit the name of a paste buffer or permanent file, XD writes the deleted text to the default (unnamed) paste buffer.

The *-R* option instructs XD to delete a rectangular block of text that you have defined by marking the upper left and lower right corners of a text region. To define the region, use the cursor and the DR command or <MARK> to specify the left corner, then move the cursor to specify the right corner. If you specify a column (the left and right corners in the same column), XD deletes all characters to the right of the column.

By default, the <CUT> key invokes the XD command using the default (unnamed) paste buffer. You must specify the XD command with the *name* argument or the *-f pathname* option to write deleted text to a named paste buffer or permanent file, respectively.

Once you have cut a range of text, you can use the XP command (described in the next section) to paste the text in elsewhere.

Pasting Text

To insert the contents of a paste buffer or file into a pad at the current cursor position, specify the **XP** command in the following format:

XP [name | -f pathname] [-R]

where *name* specifies the name of an existing paste buffer that contains the text you want to insert. The *-f pathname* option specifies the name of an existing file that contains the text you want to insert. If you do not specify the name of a paste buffer or permanent file, XP inserts the contents of the default (unnamed) paste buffer.

You can use this command only in pads created with <EDIT> or the CE command.

The *-R* option instructs XP to insert a rectangular block of text that you have copied or deleted using the XC or XD command and the *-R* option. XP uses the current cursor position as the origin (upper left corner) of the block.

By default, the <PASTE> key invokes the XP command using the contents of the default (unnamed) paste buffer. You must specify the XP command with the *name* argument or the *-f pathname* option to insert the contents of a named paste buffer or permanent file, respectively.

Using Regular Expressions

The DM search and substitute operations (described in the next several sections) allow you to use special notation, called **regular expressions**, to specify patterns for search and substitute text strings. You can also use regular expressions with the Shell commands ED (EDIT), EDSTR (EDIT_STREAM), FPAT (FIND_PATTERN), FPATB (FIND_PATTERN_BLOCK), and CHPAT (CHANGE_PATTERN). See the *DOMAIN System Command Reference* for descriptions of these Shell commands.

Regular expressions permit you to concisely describe text patterns without necessarily knowing their exact contents or format. You can create expressions to describe patterns in particular positions on a line, patterns that always contain certain characters and at times may include others, or patterns that match text of indefinite length.

Table 5-5 provides a list of the characters used to construct regular expressions and a brief description of their functions.

CAUTION: The special characters described in Table 5-5 apply only to regular expression operations. Some of these characters also have meanings (often radically different) in Shell commands and other software products. If you want to use a regular expression as a part of one of those Shell commands or products, be sure to enclose the expression in quotation marks so that it will not be misinterpreted.

Table 5-5. Characters Used in Regular Expressions

ASCII Character

Any standard ASCII character (except those listed in this table) matches one and only one occurrence of that character. By default, the case of the characters is insignificant. Use the SC (SET_CASE) command to control case significance (see the “Setting Case Comparison” section). The following examples are all valid expressions:

SAM
fred12
Joe(a&b)

Percent Sign (%)

A percent sign (%) *at the beginning of a regular expression* matches the empty string at the beginning of a line. If a % is not the first character in the expression, it simply matches the percent character. Use this special feature to mark the beginning of a line in a regular expression. For example:

%Print matches the string in line *a* but not line *b* because in line *b*, *Print* is not at the beginning of the line.

- (a) **Print** this file
- (b) This **Print** file

Dollar Sign (\$)

A dollar sign (\$) *at the end of a regular expression* matches the end-of-line character (null) at the end of a line. If \$ is not the last character in the expression, it simply matches the dollar sign character. Use this special feature to mark the end of a line in a regular expression. For example:

file\$ matches the string in line *a*, but not line *b*, because in line *b*, *file* is not followed by an end-of-line marker.

- (a) Print this **file**
 - (b) This **file** is permanent
-

**Table 5-5. Characters Used in Regular Expressions
(continued)**

Question Mark (?)

A question mark (?) matches any single character except a NEWLINE character. The only exception to this is when the ? appears inside a character class (see the “[string]” description in this table), in which case it represents the question mark character itself. For example:

?OLD??? matches the strings in lines *a* and *b*, but not line *c*, because in line *c* the letters “OLD” are alone on the line:

- (a) **HOLDING**
- (b) **FOLDERS**
- (c) **OLD**

Asterisk (*)

An asterisk (*) following a regular expression matches zero or more occurrences of that expression. The only exception to this is when the * appears inside a character class (see the “[string]” description in this table), in which case it represents the asterisk character itself. Matching zero or more occurrences of some pattern is called a **closure**. An expression used in a closure will never match a NEWLINE character. Here are some examples:

a*b matches the strings *b*, *ab*, *aab*, etc.

%a?*b matches any string that begins with *a* and ends with *b*, and that is also the first string in the line. Any number of other characters can come between *a* and *b*.

[A-Z][A-Z][A-Z]* matches any string containing at least two (and possibly more) uppercase characters (see the “[string]” description in this table). Strings like *Mary* would not match, since *Mary* does not begin with two uppercase characters.

**Table 5-5. Characters Used in Regular Expressions
(continued)**

[string]

A string of characters enclosed in square brackets [string] is called a **character class**. This pattern matches anyone character in the string but no others. Note that the other regular expression characters % \$? * lose their special meaning inside square brackets, and simply represent themselves. For example:

[sam] matches the single character *s*, *a*, or *m*. (If you want to match the word *sam*, omit the square brackets.)

[~string]

A string enclosed in square brackets whose first character is a tilde [~string] matches any single character that does *not* appear in the string. If a tilde (~) is not the first character in the string, it simply matches the tilde character itself. For example:

[~sam] matches any single character except *s*, *a*, or *m*.

[letter-letter] or **[digit-digit]**

Within a character class, you can specify anyone of a range of letters or digits by indicating the beginning and ending characters separated by a hyphen (-). For example:

[A-Z] matches any single uppercase letter in the range *A* through *Z*.

[a-z] matches any single lowercase letter in the range *a* through *z*.

[0-9] matches any single digit in the range *0* through *9*.

**Table 5-5. Characters Used in Regular Expressions
(continued)**

Remember, though, that the actual search ignores case unless you have used the SC command to specify a case-sensitive search (see the “Setting Case Comparison” section). The range can be a subset of the letters or digits. However, the first and last characters in the range must be of the same type: uppercase letter, lowercase letter, or digit. For example, `[a-n]` and `[3-8]` are valid expressions. `[A-9]` is invalid.

Note that a hyphen (-) has a special meaning inside square brackets. If you want to include the literal hyphen character in the class, it must be either the first or last character in the class (so that it does not appear to separate two range-marking characters), or you can precede the hyphen with the escape character @ (see the @ description in this table).

The right bracket (]) also has special meaning inside a character class; it closes the class descriptor list. If you want to include the right bracket in the class, precede it with the escape character @ (see the @ description in this table). For example:

[a-d] matches any single occurrence of *a*, *b*, *c*, or *d*.

%[A-Z] matches any uppercase letter that is also the first character on the line.

5-[1-9][0-9]* matches any of the page numbers in this chapter.

[0A-Z] matches any string containing a zero or an uppercase letter.

[~a-z0-9] matches any uppercase letter or punctuation mark (i.e., no lowercase letter or digit).

**Table 5-5. Characters Used in Regular Expressions
(continued)**

At Sign (@)

The at sign (@) is an escape character. Characters preceded by the @ character have special meaning in regular expressions, as indicated in the following list:

@n matches a NEWLINE character.

@t matches a tab character. Note, however, that the <TAB> key does not insert a tab character. It simply moves the cursor to the display's next tab stop. In a regular expression, @t matches only tab characters that have been inserted with @t.

@f matches a form feed character.

In addition, you can use the escape character inside a character class to specify literal occurrences of a hyphen (-) or a right bracket (]. You may also use the @ character to specify a literal occurrence of the other special characters used in regular expressions: % \$? * @. For example:

[A-Z@-@] matches any uppercase letter, a hyphen, or a right bracket.

@?@* matches a question mark followed by an asterisk, rather than zero or more occurrences of any character (?*).

{expr}

You can “tag” parts of a regular expression to help rearrange pieces of a matched string. The DM remembers a text pattern surrounded by braces {*expr*} so that you can refer to it with @*n*, where *n* is a single digit referring to the string remembered by the *n*th pair of braces. For example:

**Table 5-5. Characters Used in Regular Expressions
(continued)**

S/{???} {?*/@2@1/

S is the DM command for substituting strings of text (see the “Substituting All Occurrences of a String” section). This example of the S command moves a three-character sequence from the beginning of a line to the end of the line. ??? matches the first three characters of the line, and ?* matches the rest of the line. The @2 expression refers to the string ?* inside the second pair of braces, and @1 refers to the string ??? inside the first pair of braces. For example:

SO/{?} {?}/@2@1/

SO is also a DM command for substituting strings of text, but it only substitutes the first occurrence of the first pattern on a line (see the “Substituting the First Occurrence of a String” section). This example of the SO command transposes two characters beginning with the one under the cursor. This can be a handy key definition if you often type *ie* for *ei*, etc.

Searching for Text

The search operations shown in Table 5-6 locate strings of characters in a pad. You describe the string pattern using regular expressions (see the previous section).

Table 5-6. Commands for Searching for Text

Task	DM Command	Predefined Key
Search forward for string	/string/	None
Search backward for string	\string\	None
Repeat last forward search	//	CTRL/R
Repeat last backward search	\\	CTRL/U
Cancel search or any action involving the ECHO command	ABRT	CTRL/X
Set case comparison for search	SC [-ON] [-OFF]	None

To search forward from the current cursor position, enclose the regular expression in slashes as follows:

/string/

To search backward from the current cursor position, enclose the regular expression in backslashes as follows:

\string

A search operation moves the cursor to the first character in the pattern specified by *string*. If necessary, the pad moves under the window to display the matching string. If the search fails, the cursor

position does not change, and the DM displays the message “No match” in its output window.

Searches do not wrap around the end or beginning of the file. Therefore, to search an entire pad, position the cursor at the beginning of the pad.

By default, searches are not case-sensitive. This means, for example, that */mary/* will locate *mary*, *MARY*, and even *maRy*. To perform a case-sensitive search, use the *SC* command (see the “Setting Case Comparison” section).

Actually, a search is not syntactically a command. It is a pointing operation. Note (as described in the “Defining Points and Regions” section in Chapter 3) that one way to specify a point in a pad is by matching a regular expression. This means that the search operation is really a pointing action followed by a null command. Consequently, you should not think of search operations as operating on a text range, but rather searching from the initial cursor position to the end (or beginning) of the file in order to properly position the cursor.

If the DM scans more than 100 lines in a search operation, it displays a “Searching for */string/ ...* “ message in its output window. Then it polls for keystrokes every 10 lines it processes. At this point, you may:

- Wait for the DM to complete the operation.
- Cancel the search by typing *CTRL/X*, or by pressing a key that has been defined to invoke the *ABRT* or *SQ* command (see the “Cancelling a Search Operation” section).
- Use the keyboard; it works as it normally does. You can type into any pad except the one being searched. You can specify any DM command except another search or substitute command. The DM executes these commands when it completes the search. You can type input to another Shell or program (if it was previously waiting for input). The process executes these commands when the DM finishes the search.

Repeating a Search Operation

To repeat the last search forward, specify the // command or type the **CTRL/R** sequence.

To repeat the last search backward, specify the \\ command or type the **CTRL/U** sequence.

The DM saves the most recent search instruction, so you may repeat it even if you have specified other (non-searching) commands since then.

Cancelling a Search Operation

To cancel the current search operation, type **CTRL/X**. The **CTRL/X** sequence invokes the **ABRT** command. Since you cannot type DM commands for the pad being searched, you must use **CTRL/X** or define a key to invoke the **ABRT** command (see the “Defining Keys” section in Chapter 4).

The DM command **SQ** also cancels a search operation. As with the **ABRT** command, you must define a key to invoke **SQ** during a search.

When you type **CTRL/X** or press a key defined to invoke **ABRT** or **SQ**, the DM displays the message “Search aborted” in its output window.

Setting Case Comparison

As we said earlier, a search operation is not case sensitive by default.

In a case-insensitive search, upper- and lowercase letters are equivalent. In a case-sensitive search, the characters must match in case (i.e., */mary/* will not locate */MARY/*).

To set case comparison for a search, specify the **SC** (**SET_CASE**) command in the following format:

SC [-ON | -OFF]

The *-ON* option specifies a case-sensitive search, and the *-OFF* option specifies a case-insensitive search. The *SC* command without options toggles the current case comparison setting.

Substituting Text

The commands shown in Table 5-7 allow you to search a pad or part of a pad for a text string, and to replace the string with a new string. Before specifying a substitute command, use the *DR* command or *<MARK>* to define the range of text in which you want the substitution to occur (see the “Defining a Range of Text” section earlier in this chapter). If you do not define a range, the substitution occurs from the current cursor position to the end of the line.

Unlike searches, which ignore case unless told otherwise, all substitutions are case-sensitive. You cannot make a substitution case-insensitive.

Table 5-7. Commands for Substituting Text

Task	DM Command	Predefined Key
Substitute <i>string2</i> for all occurrences of <i>string1</i> in a defined range	S/string1/string2	None
Substitute <i>string2</i> for the first occurrence of <i>string1</i> in each line of a defined range	SO/string1/string2/	None
Change case of each letter in a defined range	CASE [-S] [-U] [-L]	None

If the DM scans more than 100 lines while processing a substitute command, it displays a “Substitute in progress ... “ message in its output window. Then it polls for keystrokes every 10 lines it processes. At this point, you may:

- Wait for the DM to complete the substitute operation.
- Use the keyboard; it works as it normally does. You can type into any pad except the one where the substitution is occurring. You can specify any DM command except another search or substitute command. The DM executes these commands when it completes the substitution. You can type input to another Shell or program (if it was previously waiting for input). The process executes these commands when the DM finishes the substitution.

Substituting All Occurrences of a String

To replace all occurrences of a text string with a new text string, specify the **S** (**SUBSTITUTE**) command in the following format:

S[[/[string1]]/string2/]

where *string1* specifies the string to be replaced. Use a regular expression to describe *string1*. If you supply the first delimiter (/) but omit *string1* (i.e., *S//string2/*), *string1* defaults to the string used in the last **search** operation. If you also omit the delimiter (i.e., *S/string2/*), then *string1* defaults to the string used in the last substitute operation.

The *string2* argument specifies a literal replacement string (not a regular expression). If you supply *string1*, then *string2* is required.

You can use an ampersand (&) to instruct the S command to use *string1* as part of *string2*. For example:

S/Tom/& Smith/

This command replaces all occurrences of *Tom* with *Tom Smith* over the defined range of text.

The S command does not move the cursor or the pad, but does update the pad when the substitution is complete.

Substituting the First Occurrence of a String

The **SO** (**SUBSTITUTE_ONCE**) command is like the **S** (**SUBSTITUTE**) command except that **SO** replaces only the first occurrence of a string in each line of a defined range of text. Specify the **SO** command in the following format:

SO[[/[string1]]/string2/]

where *string1* specifies the string to be replaced. Use a regular expression to describe *string1*. If you supply the first delimiter (/) but omit *string1* (i.e., *SO//string2/*), *string1* defaults to the string used in the last search operation. If you also omit the delimiter (i.e., *SO/string2/*), then *string1* defaults to the string used in the last substitute operation.

The *string2* argument specifies a literal replacement string (not a regular expression). If you supply *string1*, then *string2* is required.

You can use an ampersand (&) to instruct the **SO** command to use *string1* as part of *string2*. For example:

SO/Tom/& Smith/

This command replaces the first occurrence of *Tom* with *Tom Smith* in each line of the defined range of text.

The **SO** command does not move the cursor or the pad, but does update the pad when the substitution is complete.

Changing the Case of Letters

To change the case of letters in a defined range of text, specify the **CASE** command in the following format:

CASE [-S] [-U] [-L]

where *-S* swaps all uppercase letters for lowercase and all lowercase letters for uppercase. The *-U* option changes all letters in the defined range to uppercase, and *-L* changes all letters to lowercase. **CASE** without options swaps all uppercase letters for lowercase and all lowercase letters for uppercase.

Undoing Previous Commands

To undo the most recent DM command you entered, specify the **UNDO** command. You can also undo the previous command by pressing the **<UNDO>** key.

NOTE: The UNDO command only applies to DM operations. You cannot undo Shell commands.

The UNDO command works by compiling a history of DM operations in input and edit pads in reverse chronological order. UNDO reverses the effect of the most recent DM command you specified. Successive UNDOs reverse DM commands further back in history.

To compile its history of activities, the DM uses undo buffers (one per edit pad and one per input pad). The undo buffers are circular lists that, when full, eliminate the oldest entries to make room for new ones.

The DM groups entries together in sets. For example, an S (SUBSTITUTE) command may change five lines. While the DM considers this to be five entries, the five entries are grouped into a single set so that one UNDO will change all five lines back to their original state. When a buffer becomes full, the DM erases the oldest set of entries. This means that UNDO will never partially undo an operation; it will either completely undo the operation or do nothing.

An undo buffer for an edit pad can hold up to 1024 entries. An undo buffer for an input pad can hold up to 128 entries.

Updating an Edit File

To update a file that you are currently editing, specify the **PW** (**PAD_WRITE**) command. PW is valid for edit pads only. It requires no arguments or options.

The first time you specify PW during an editing session, the DM writes the contents of the edit pad to the file that is being edited, without closing the edit pad. The DM writes the previous contents of the file to a file with the same name and the added suffix **.BAK**. Subsequent PW or WC (**WINDOW_CLOSE**) commands rewrite the new file and leave the **.BAK** version unchanged. (For more informa-

tion about the WC command, refer to the “Closing Pads and Windows” section in Chapter 4)

PW is similar to WC with two exceptions:

1. PW leaves the edit pad open so that you can continue editing the file.
2. PW writes the new version of the file even if other windows are viewing the edit pad.

PW is useful if, for example, you want to try compiling a program you are editing. If you decide to make additional changes to the program, you can just go back to the edit pad and continue editing, since updates made by PW leave the edit pad open and active.

You can also update an edit file by pressing the **<SAVE>** key or the CTRL/Y sequence (see the “Closing Pads and Windows” section in Chapter 4).

Using the Shell

Chapter 3 describes the Display Manager (DM), the operating system program that you use to create processes and control your node's display. We supply another operating system program, called the **command Shell**, that lets you perform more traditional computing operations. The Shell lets you enter commands to perform such operations as copying files and directories, compiling and running programs, and monitoring system activity.

This chapter describes the command Shell environment that processes Shell commands. The chapter includes information on:

Shell commands, controlling command input and output, the command line parser, and using pathname wildcards.

Shell Commands

The command Shell runs in a process called a **Shell process**. As shown in Figure 6-1, you enter Shell commands in the Shell's process input pad, referred to simply as the **Shell input pad**. To specify a Shell command, type the name of the command next to the dollar sign (\$) prompt and press <RETURN>.

Most Shell commands that you specify in the Shell input pad are actually the names of command files that the Shell looks for and executes. For example, when you specify the command **DATE**, the Shell looks for a command file named *DATE* and executes it. The Shell looks for command files according to a set of command search rules that indicate which directories the Shell should search. You'll learn more about command search rules later in this chapter.

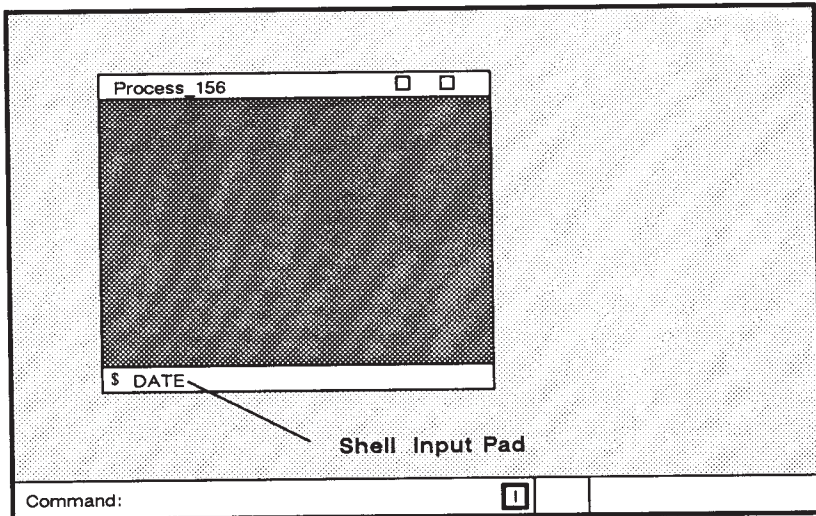

Figure 6-1. The Shell Process

As part of the DOMAIN system, we supply a set of Shell commands for your use. You've seen many of these commands in *Getting Started With Your DOMAIN System*. The *DOMAIN System Command Reference* provides detailed descriptions of all the commands

that we supply. You can also create your own Shell commands, called **Shell scripts**, and execute them in the same way you execute the Shell commands that we supply. Chapter 9 describes how to write Shell scripts.

Command Line Format

Shell command lines have the following format:

COMMAND [options ...] [arguments ...] [options ...]

COMMAND is the name of either a Shell command or Shell script.

Arguments indicate which objects you want the command to operate on. An argument is either the pathname of an object in the naming tree, or a literal string that you want the command to manipulate. Always separate an argument from a command and any additional arguments or options with at least one blank space.

Options direct the command to perform a special action. As shown in the command line format, you can specify options either before or after arguments on the command line. Many options require secondary arguments of their own. Therefore, to properly delimit options, always precede each option with a hyphen (-).

Figure 6-2 shows a sample command line and its components.

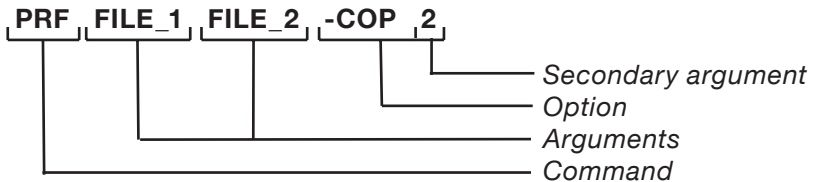

Figure 6-2. Shell Command Line Components

The command line in Figure 6-2 prints two files: *FILE_1* and *FILE_2*. The *-COP* option directs PRF to print two copies of each file.

Normally, you specify each command as a separate line. You can also place multiple commands together on the same line by separating them with semicolons (;). For example:

```
$ WD //MY_DIR/SUB_1; LD
```

executes two commands: WD sets the working directory to *//MY_DIR/SUB*, and LD lists the contents of that directory.

You may also specify multiple commands on a single line when you use pipes and filters. The “Redirecting Output to Other Commands” section describes how to use pipes and filters.

The DM limits each Shell command line to 256 characters. You can, however, continue a command over several lines by typing an at sign (@) character and then pressing <RETURN> at the end of each line you want to continue, as follows:

```
$ WD //NODE@ <RETURN>
$_ /DIRECTORY <RETURN>
```

The @ character is a special character (see the “Special Characters” section) called an **escape character**. In this example, the @ character “escapes” the normal execution of the <RETURN>, allowing you to continue the command line at the continuation prompt (\$_).

Standard Command Options

All Shell commands that we supply allow you to specify the standard command options listed in Table 6-1. These options allow you to display useful information about a command.

Table 6-1. Standard Shell Command Options

Option	Description
-HELP	Displays detailed information on how to use the command.
-USAGE	Displays a brief summary on how to use the command.
-VERSION	Displays the command's software version number.

Command Search Rules

As mentioned earlier, most commands are the names of files. Since you usually specify command names, rather than the full pathnames of the files they represent, the Shell searches different locations in the system naming tree for the file that matches the command name you specify. When you specify a command, the Shell determines which directories to search according to a set of **command search rules**.

Some commands, such as **INLIB (INITIALIZE_LIBRARY)** are not files. They invoke internal Shell functions and do not follow command search rules. The *DOMAIN System Command Reference* identifies which commands are internal Shell commands.

The default command search rules direct the Shell to search the following directories in the order shown:

- Your current working directory (**.**)
- Your personal command directory (**~COM**)
- The system command directory (**/COM**)

When you specify a command, the Shell searches the directories in the order specified by the command search rules. As soon as the Shell finds a file with the name that matches the command you specified, it attempts to execute the file.

For example, when you specify the Shell command:

```
$ LD
```

the Shell first looks for a file named *LD* in your current working directory. If the Shell does not find the file in the current working directory, it checks the directory *~COM*, which is a subdirectory of your naming directory. The *~COM* directory is your personal command directory where you store your own frequently used Shell scripts. (Please note that you don't have to create a personal command directory; if the Shell doesn't find one, it continues its search and no error occurs.)

The final directory that the Shell searches is the node's main command directory */COM*, which contains all of the standard commands that we supply. Since *LD* is a system command, the Shell finds it in */COM* and executes it, sorting *MY_FILE* and displaying output.

This example assumes that you have not created an executable file or Shell script named *LD* in your working directory or personal command directory. Had you done so, the Shell would have executed your version of *LD* before the system's version.

You can set or show a Shell's command search rules using the **CSR** (**COMMAND_SEARCH_RULES**) command. For example, the CSR command in the following example displays the Shell's command search rules:

```
$ CSR
. ~com /com
```

You can use the **-A** option with the CSR command to append additional directories to the current list. For example, the following example adds two additional directories (*~PROG* and */PROG*) to the current set:

```
$ CSR -A ~PROG /PROG
$ CSR
. ~com /com ~prog /prog
```

To completely change a set of command search rules, specify the CSR command along with a new set of rules. For example:

```
$ CSR /COM ~COM
$ CSR
/com ~com
```

If you change a Shell’s command search rules, any subordinate Shell (created with the SH (SHELL) command), or Shell script that you invoke, inherits the new command search rules. If you create a new process running the Shell (see Chapter 4), the new Shell uses the original default command search rules, **not** the new rules.

Special Characters

The Shell recognizes a variety of special characters that allow you to direct the action of commands. These characters are divided into three basic categories:

- input and output (I/O) control characters
- pathname wildcards
- parsing operators

The following sections explain how to use I/O control characters and pathname wildcards. Since you will use Shell command parsing operators most frequently in Shell scripts, we describe parsing operators in detail in Chapter 9, “Writing Shell Scripts.”

Creating and Invoking Shells

The Shell is a command line interpreter that reads command lines that you type and interprets them as requests to execute other programs. When you press the <SHELL> key, you create a process

running the Shell program. Each new Shell process that you create provides a separate environment in which the Shell runs.

You can invoke additional Shells from within a Shell process using the Shell command **SH (SHELL)**. When you specify **SH**, you generate a separate subordinate Shell, in which you can carry on separate operations and execute programs and scripts. Note that the **SH** command does not create a new process, only a subordinate Shell running in the current process. Each subordinate Shell inherits environment characteristics, such as variables and command search rules, from its parent Shell.

Setting Up the Initial Shell Environment

Whenever you create a new process to run the Shell (see Chapter 4), the system looks for a file called *STARTUP* in the directory *~USER_DATA/SH*. If the file exists, the system executes it to set up the initial environment for the Shell.

Since no default Shell start-up file exists, you must create one if you want to use one. The Shell start-up script is useful when you want to define a standard set of variables for each Shell process, or set up certain Shell characteristics, such as variable evaluation (EON), or new command search rules. Figure 6-3 shows a sample Shell startup script.

Note: Shell start-up files do not execute from *siologin* or **CRP (CREATE_REMOTE_PROCESS)**. For more information about the **CRP** command, see the *DOMAIN System Command Reference*.

```
# Sample Shell start-up script -USER_DATA/SH/STARTUP
#
# Set up standard variables
#
A := 3
B := 4

# Turn on variable evaluation
#
EON

#
# Add additional directory to command search rules
#
CSR -A -PROGS

#
```

Figure 6-3. Sample Shell Start-Up Script

Controlling Input and Output

Processes pass data to and from programs, such as the Shell, through open system channels called **streams**. Every process that you create has the following streams open for program input and output:

- standard input
- standard output
- error input
- error output

Standard input and **standard output** are the streams that channel normal input and output between a program and a process. By default, standard input passes program input that you type in the

process input pad; standard output passes program output to the process transcript pad.

Error input and **error output** are two streams used for additional program input and output. Like the standard streams, they use the process input pad and process transcript pad by default.

The error input stream has nothing to do with errors; it is simply another input stream for passing data to a program. For example, when a command queries you to verify wildcard names, error input passes your response to the command. (The “Using Query Options” section describes how commands query you to verify wildcard names.) Error output is the stream that passes program error messages to the process transcript pad.

Shell commands use input and output streams when processing command line data. When you specify a command in the Shell input pad, standard input passes data from the command line to the command program. Standard output passes data from the program to the transcript pad.

In certain instances, you may want the Shell to read input from and write output to locations other than the input and transcript pads. For example, you may want to save the output from a command in a file. Using **I/O control characters**, you can redirect input and output streams to pass data to and from other locations, usually files.

Table 6-2 lists the I/O control characters and a brief summary of their functions.

The following sections show how to use I/O control characters. Chapter 9 describes the characters used to redirect standard input to read in-line data from scripts.

Table 6-2. I/O Control Characters

Character	Function
<	Redirect standard input
< ?	Redirect error input
>	Redirect standard output
> ?	Redirect error output
>>	Append standard output
>> ?	Append error output
	Pipe standard output
()	Group commands for I/O redirection
<<	Redirect standard input to read in-line data from scripts. (See Chapter 9 for a complete description.)
<< ?	Redirect error input to read in-line data from scripts. (See Chapter 9 for a complete description.)

Reading Input from a File

To redirect standard input to read data from a file rather than the input pad, use the less-than symbol (<). For example, the following command reads data from a file named *FILE_1*:

```
$ TLC a-z A-Z < FILE_1
```

The **TLC (TRANSLITERATE_CHARACTERS)** command normally substitutes or deletes characters from text that you type in the Shell input pad. The TLC command in this example redirects standard input to read data from a file (*FILE_1*) instead of the input pad. The command changes all lowercase characters in *FILE_1* to uppercase characters, and writes the converted text to the transcript pad.

Writing Output to a File

To redirect standard output to write output to a file rather than to the transcript pad, use the greater-than (>) symbol. For example, the following command writes output to a file named *FILE_1.FMT*:

```
$ FMT FILE_1 > FILE_1.FMT
```

The **FMT (FORMAT_TEXT)** command formats *FILE_1* and writes the output (the formatted file) to *FILE_1.FMT* instead of to the transcript pad.

Shell commands use the error output stream to report any errors found in the input file. By default, error output writes output to the transcript pad. To redirect error output to write output to a file instead of the transcript pad, use the greater-than/question mark symbol (>?). For example, the following command redirects both standard output and error output:

```
$ FMT FILE_1 > FILE_1.FMT >? FILE_1.ERR
```

The FMT command writes the formatted file to *FILE_1.FMT*, and if it discovers any errors, writes error messages to the file *FILE_1.ERR*.

Appending Output to a File

To redirect standard output to append output to the end of a file, use the double greater-than symbol (>>). For example, the following command appends output to a file named *BOOK*:

```
$ CATF CH4 CH5 CH6 >>BOOK
```

The **CATF** (**CATENATE_FILE**) command normally reads input files in order and writes them to the transcript pad. The CATF command in this example reads the files *CH4*, *CH5*, and *CH6* in that order and appends them to the existing file *BOOK*. If the specified output file didn't exist, CATF would create a new file named *BOOK* and write output to it.

To redirect error output to append error output to the end of a file, use the double greater-than/question mark (`>>?`) symbol. For example, suppose you wanted to keep a record of all FMT errors. Each time you used the FMT command to format a file, you could direct the command to append error output to a file as follows:

```
$ FMT FILE_1 >>?ERROR_LOG
```

The command in this example formats *FILE_1*. If it encounters any errors, it appends any error output to the file *ERROR_LOG*.

Redirecting Output to Other Commands

If you place two commands on one line, and separate them with a vertical bar (`|`), the Shell connects the standard output stream of the first command to the standard input stream of the next command. For example:

```
$ SRF FILE_1 | DLDUPL
```

The **SRF** (**SORT_FILE**) command sorts the contents of *FILE_1* and passes the output to the Shell command **DLDUPL** (**DELETE_DUPLICATE_LINES**) command. The DLDUPL command strips out duplicate lines.

The vertical bar between the commands is called a **pipe**. Commands such as SRF and DLDUPL that copy standard input to standard output (making some changes along the way) are called **filters**. A command line that uses pipes and filters is called a **pipeline**. You can use either Shell commands or scripts as filters in pipelines.

To use a group of commands as a filter, enclose them in parentheses using the following format:

```
(COMMAND_1; COMMAND_2) | COMMAND_3
```

The Shell passes output from the commands enclosed in parentheses (*COMMAND_1* and *COMMAND_2*) to the command to the right of the vertical bar *COMMAND_3*. For example:

```
$ (LD MY_DIR1 -C -NHD; LD MY_DIR2 -C -NHD) | SRF >@  
$_ LIST
```

This example concatenates the output of the two `LD(LIST_DIRECTORY)` commands and then sorts the reported file names, placing the output in the file called *LIST*.

The Command Line Parser

Many of the Shell commands that we supply share a standard command line parsing procedure. This procedure, called the **command line parser**, determines how each command processes command line information. The Shell command descriptions in the *DOMAIN System Command Reference* and the on-line HELP files identify which commands use the command line parser.

Commands that use the command line parser allow you to:

- Specify multiple pathnames as pathname arguments.
- Use pathname wildcards to specify existing pathnames and to derive pathnames from other pathnames on the command line.

Commands that use the command line parser also accept the command parser options listed in Table 6-3. These options allow you to:

- Control how a command queries you to verify wildcard matches.
- Direct a command to use standard input to read command line input.

Table 6-3. Command Line Parser Options

Option	Description
-AE	Causes the command to abort if it cannot find a name in a pathname. By default, processing continues to the next name.
-NQ	Do not issue a query to verify wildcard names. This is the default.
-QW	Issue a query to verify wildcard names.
-QA	Issue a query to verify all names.
-	Read additional data from standard input.
* [pathname]	Read the specified file for additional pathname arguments. If the pathname is omitted, read the additional pathname arguments from standard input.

Using Query Options

Commands that delete or modify objects query you to verify names that you specify using wildcards. You can control how a command queries by using any of the query options listed in Table 6-4.

By default, commands use error output to query you by writing selected names to the transcript pad with a question mark (?), prompting you for a response. The command uses the error input stream to read your response from the Shell input pad.

To respond, type one of the responses listed in Table 6-4 and press <RETURN>.

Table 6-4. Command Query Responses

Response	Action
H [elp]	Displays HELP information.
Y [es]	Operates on the file with that name.
N [o]	Ignores the file with that name.
Q [uit]	Quits immediately.
G [o]	Operates on the file with that name and suppresses further name queries.
D [efault]	Resets the default response.

By default, queries require a response; if you simply type <RETURN> without a response, the command queries you again. To change the default, use the *D* response, followed by either YES, NO, or NONE. For example:

```
? D YES
```

sets the default to *YES*. If you respond to subsequent queries by typing <RETURN>, the command uses the new default and operates on the file with that name. *NONE* specifies that you must specify a response.

Reading Data from Standard Input

When you enter a Shell command, the command normally reads input data from arguments that you specify in the command line. For example, the **PRF (PRINT_FILE)** command reads data from the specified files and prints it. To direct the command to read data from standard input instead of an input file, use the hyphen character (-) as shown in the following example:

```
$ PRF - <RETURN>
PRINT THIS LINE ON THE LINE PRINTER <RETURN>
AND THIS ONE TOO <RETURN>
CTRL/Z
```

Standard input uses the Shell input pad by default, so PRF reads data from the input pad. To input data to the PRF command, type in data as shown in the example. The CTRL/Z control key inserts an end-of-file (EOF) that signals the end of input and causes PRF to print any data that you typed in the input pad.

Some commands and scripts receive data from both a list of files and standard input. For these commands, specify the hyphen character (-) as a pathname argument. For example:

```
$ FMT FILE_1 - FILE_2
```

The FMT command: formats *FILE_1*, formats data typed in standard input, and finally formats *FILE_2*.

Reading Path names from Standard Input

To direct a command to read *pathnames* (rather than data) from standard input, use the asterisk symbol (*). The PRF command in the following example reads pathname arguments that you type in the Shell input pad:

```
$ PRF - <RETURN>
FILE_1 <RETURN>
FILE_2 <RETURN>
FILE_3 <RETURN>
CTRL/Z
```

The CTRL/Z control key inserts an end-of-file (EOF) that signals the end of input, which causes PRF to print the contents of each file.

You can also use the asterisk symbol and redirect standard input to read pathnames from a **names file**, a file that contains the pathnames of other files, as follows:

```
$ PRF *JOBS
```

In this example, PRF prints the contents of each file listed in the names file JOBS.

Using Pathname Wildcards

Most Shell commands accept pathnames as arguments. The commands that use the command line parser also accept **wildcards** as part of their pathname arguments. Wildcards are characters or text strings that you can use in pathnames to represent one or more text strings in a pathname. For example, the wildcards in the following command line match every file that ends with *.FTN* in the current working directory:

```
$ LD ?*.FTN
      └─┬─┘
        wildcards
```

The question mark wildcard (?) matches any single character except <RETURN>. The asterisk wildcard (*) matches zero or more occurrences of the character preceding it. As a result, this wildcard combination matches zero or more occurrences of any character.

Table 6-5 provides a list of pathname wildcards along with a brief description of how they work. Chapter 7 describes how to use Shell commands to manage files, directories, and links. Many of the examples in Chapter 7 provide specific examples of how to use pathname wildcards.

Table 6-5. Summary of Path name Wildcards

Character	Description
?	<p>Matches any single character except <RETURN>. For example:</p> <p>Z? matches any two-character name that begins with the letter Z (<i>ZA</i> and <i>ZI</i>).</p>
%	<p>Matches zero or more characters up to, but not including, a period. For example:</p> <p>%.BAK matches any name that ends in <i>.BAK</i> (<i>SALES.BAK</i> and <i>INV.BAK</i>, but not <i>SALES.BAK.BAK</i>)</p> <p>DEMO.% matches any name that begins with <i>DEMO</i>, up to and including the period (<i>DEMO.BAK</i> and <i>DEMO.PAS</i>)</p> <p>DEMO.%.% matches <i>DEMO.PAS.BAK</i></p>
*	<p>Matches zero or more occurrences of the character that precedes it. When * follows the ? character, it matches zero or more occurrences of any character except <RETURN>. For example:</p> <p>FILE9* matches <i>FILE</i>, <i>FILE9</i>, and <i>FILE999</i>.</p> <p>DE?* matches <i>DEMO</i>, <i>DESK</i>, and <i>DEPARTMENT</i>.</p> <p>DEMO.*% matches any name that <i>DEMO.%</i> matches (see the % example above), but also matches the period (<i>DEMO.FMT</i> and <i>DEMO</i>).</p>

Table 6-5. Summary of Pathname Wildcards (continued)

Character	Description
[string]	<p>Matches any single character listed in a string. For example:</p> <p>FILE[0-9] matches any five-character name that begins with <i>FILE</i> and ends in a single digit (<i>FILE4</i> and <i>FILE8</i>)</p> <p>FILE[A-D] matches <i>FILEA</i> and <i>FILEB</i> but not <i>FILEM</i></p> <p>FILE[AXY] matches <i>FILEA</i>, <i>FILEX</i>, and <i>FILEY</i></p>
[~string]	<p>Matches any single character that does not appear in a string. For example:</p> <p>FILE.[~A-Z] matches <i>FILE</i> and <i>FILE.9</i> but not <i>FILE.A</i> or <i>FILE.P</i></p>
...	<p>Matches zero or more directories subordinate to the starting point. For example:</p> <p>//MY_NODE/... matches all the directories in <i>MY_NODE</i></p> <p>/OWNER/.../DEMO matches any object named <i>DEMO</i> in a subdirectory of <i>OWNER</i></p> <p>.../JAN?* matches any object starting with <i>JAN</i> in all subdirectories of the current working directory</p>

Table 6-5. Summary of Pathname Wildcards (continued)

Character	Description
=	<p>Shell commands that let you copy, compare, or rename files sometimes require two pathnames as arguments. Many of these commands derive the second name from the first name. In this case, we refer to the second name as the derived name. The Shell replaces the equal sign wildcard (=) in the second name with the first name. For example:</p> <p>CPF MY_FILE=.OLD copies the file <i>MY_FILE</i> to the file <i>MY_FILE.OLD</i></p> <p>CPF MEMO MY=.BAK copies the file <i>MEMO</i> to <i>MYMEMO.BAK</i></p>
(names) derived-name	<p>Enclose the first names in parentheses to create several derived names with one command line.</p> <p>For example:</p> <p>CPF (A B C) =.FMT copies the files <i>A</i>, <i>B</i>, and <i>C</i> to <i>A.FMT</i>, <i>B.FMT</i>, and <i>C.FMT</i></p>
{ expr }	<p>Use braces to tag an expression (<i>expr</i>) for use in a derived name. Refer to tagged expressions in arguments as @1 (first expression tagged), @2 (second expression tagged), etc. For example:</p> <p>CPF {PROG.FTN}.BAK @1 copies <i>PROG.FTN.BAK</i> to <i>PROG.FTN</i></p> <p>CPF {FILE}_E_{A} @1.@2 copies <i>FILE_A</i> to a file named <i>FIL.A</i></p>

Running Programs in a Background Process

The command Shell has another set of special characters, called **parsing operators**, that control how a command parses (interprets and categorizes) the individual components on a command line. We've already seen how to use some of these parsing operators: the semicolon (;) to separate multiple commands on a command line, the escape character (\) to continue commands on more than one line, and blank spaces to separate command arguments and options.

Another parsing operator is the **ampersand character (&)**. It instructs the Shell to run a program in a **background process** (a process that runs without pads and windows). To run a command or program in a background process, enter the command line or program name in the Shell input pad, followed by the & character. For example:

```
$ BIND FILE_1.BIN -MAP > PROG.MAP &
```

This command line runs the binder as a background process to bind the file *FILE_1.BIN* and writes a complete map to the file *PROG.MAP*.

By default, the Shell directs output to the file */DEV/NULL*. You can display output from the background process by specifying the Shell command **BON**. The BON command directs the Shell where the background process was invoked to display output in its transcript pad. To turn output off (direct output to */DEV/NULL*), specify the **BOFF** command.

The remainder of the Shell parsing operators are used most frequently in scripts. Chapter 9 contains a complete list of parsing operators and describes how to use them in writing Shell scripts.

Managing Files, Directories, and Links

In Chapter 1, we looked at how the system organizes objects (files, directories, and links) in a structure called a naming tree. This chapter describes how to use Shell commands to manage these objects on your system. Shell commands let you move around the system naming tree and create, rename, copy, move, print, delete, and compare objects.

Since all of the commands described in this chapter require you to specify pathnames, you should understand the rules for pathnames described in Chapter 1. Commands that use the Shell command line parser also allow you to perform operations on groups of objects, and

therefore accept one or more pathname wildcards. Many of the examples in this chapter show you how to use pathname wildcards in specific operations. For a complete description of the pathname wildcards you can use with Shell commands, refer to Chapter 6.

Keep in mind that this chapter describes the *basic* functions of the commands you use to manage objects. For a complete description of a particular command and all of its options, refer to the *DOMAIN System Command Reference*.

Moving Around the Naming Tree

Most of the commands described in this chapter require you to use pathnames to specify locations in the naming tree where you want particular operations performed. Often, you will specify pathnames that use the current working directory or naming directory. To move around the naming tree, you need to know how to set your working directory and naming directory. Table 7-1 summarizes the commands used to move around the naming tree.

Table 7-1. Commands for Setting the Working and Naming Directory

Task	Shell Command
Set or display working directory	WD [pathname]
Set or display naming directory	ND [pathname]

Setting the Working Directory

The working directory is where the system begins its search for objects when you omit the object's full pathname. At log-in, the system sets your initial working directory to the home directory designated in your user account (see Chapter 2). Each subsequent process that you create uses the working directory of the previous process as its working directory.

To display the name of a process's current working directory, specify the **WD (WORKING_DIRECTORY)** command without any arguments or options as follows:

```
$ WD
```

To change a process's working directory to another directory, specify the **WD** command in the following format:

```
WD [pathname]
```

where *pathname* specifies the pathname of the directory you want to use as the working directory. For example:

```
$ WD //MY_NODE/OWNER/FORMS
```

sets the working directory for the current process to *FORMS*. Once set, anytime you omit the full pathname of an object, the system starts its search at the directory *FORMS* by default.

Setting the Naming Directory

The system searches the naming directory's *COM* directory (*~COM*) as part of the default command search rules (see Chapter 6). As described in Chapter 1, the naming directory is also where the system begins its search for an object when you precede an object's pathname with the tilde (~) symbol.

At log-in, the system sets the naming directory to the home directory designated in your user account (see Chapter 2). Each subsequent process that you create uses the naming directory of the previous process as its naming directory.

To display the name of a process's current working directory, specify the **ND (NAMING_DIRECTORY)** command without any arguments or options as follows:

```
$ ND
```

To change a process's naming directory to another directory, specify the ND command in the following format:

```
ND [pathname]
```

where *pathname* specifies the pathname of the directory you want to use as the naming directory. For example:

```
$ ND /USER_1/REPORTS
```

sets the naming directory to the directory *REPORTS*. Once set, you can use a tilde (~) in place of */USER_1/REPORTS* at the beginning of any pathname. Thus, *~CAL_85* would be the same as */USER_1/REPORTS/CAL_85*.

Managing Files

Table 7-2 summarizes the commands for managing files.

Table 7-2. Commands for Managing Files

Task	Shell Command
Create a file	CE pathname (DM command)
Rename a file	CHN old_name [new_name]
Copy a file	CPF source [target]
Move a file	MVF source [target]
Append a file to another file	CATF source >>target
Print a file	PRF [pathname]
Display file attributes	LD [pathname]
Delete a file	DLF [pathname]
Copy display Image to a file	CPSCR pathname
Compare ASCII files	CMF source [target]
Compare sorted files	CMSRF [options] source [target]

Creating Files

To create normal text files, specify the DM command **CE** (**CREATE_EDIT**) along with the pathname of the file you want to create. By default, the **<EDIT>** key invokes the CE command. The CE command directs the DM to create the file and open an edit pad and window for the file on the display. Using the DM editor, you can edit the file then save its contents by typing CTRL/Y. When you save the file, the system stores it at the location in the naming tree

specified by the file's pathname. Refer to the "Creating Pads and Windows" section in Chapter 4 for a description of how to use the CE command to create and edit files.

The following example creates a file named *MEMO* in the directory */USER*, and opens the file for editing:

Command: `CE //NODE/USER/MEMO`

The previous example uses an absolute pathname to specify the name of the new file. When you use a pathname that assumes the current working directory or naming directory, the system uses the working or naming directory of the current process. (The last process to perform an operation before you specified the CE command is the current process.)

The following example creates a file named *MEMO* in the current working directory:

Command: `CE MEMO`

The command in this example specifies the filename *MEMO*. Since the pathname does not specify an explicit directory location, the system uses the current process's working directory to determine where to create the new file. If the current process's working directory is *//NODE/USER*, then the system will create the new file with the pathname *//NODE/USER/MEMO*.

When you run multiple Shell processes, you typically move between processes, often changing the current working directory. As a result, you may find it difficult to keep track of the current working directory. In situations where you run multiple processes, you may want to specify absolute pathnames to avoid creating files at an unintended location.

Whenever you create a file, the system assigns the file a set of initial ACLs from the file's parent directory. After you create a file you can change its ACLs with the EDACL command. Chapter 8 explains ACLs and describes how to use the EDACL command.

Renaming Files

To change the name of a file, use the **CHN (CHANGE_NAME)** command in the following format:

```
CHN old_name [new_name] [options]
```

where *old_name* specifies the current pathname of the file you want to rename, and *new_name* specifies the new name of the file. For example:

```
$ CHN /OWNER/JOHN PAUL
```

changes the name of the file *JOHN* to *PAUL*. Notice that the *new_name* argument applies to the rightmost component (*JOHN*) of the *old_name* argument.

To append a naming suffix to the new filename, specify any of the following naming options:

Option	Description
-D	Appends the current month and day to the new name (new_name.mm.dd).
-Y	Appends the current year, month, and date to the new name (new_name.yy.mm.dd).
-U	Forces the system to create a unique new name by appending a sequence of number(s) to the end of the name.

If you omit the *new_name* argument, you must specify one of the options in the previous list; the system creates a new name by copying the *old_name* and appending the proper suffix as shown below.

```
$ CHN /OWNER/JOHN -D
```

This command changes the name of the file *JOHN* to *JOHN.06.16*.

Copying Files

When you copy a file, you create a copy of the file at another location in the naming tree. To copy a file or group of files, use the **CPF** (**COPY_FILE**) command in the following format:

```
CPF source [target] [options]
```

where *source* specifies the pathname of the file you want to copy, and *target* specifies the pathname of the naming tree location where you want the copy created. The rules for pathnames described in Chapter 6 apply to both command arguments.

The CPF command always creates a copy of the source file at the location specified by the target. For example:

```
$ CPF MEMO /USER_1/NEW_MEMO
```

creates a copy of the source file *MEMO* in the directory *USER_1*. In this example, since the target specifies the pathname of a file, CPF assigns the copy the name specified by the target, which in this example is *NEW_MEMO*.

If the target specifies the pathname of a directory, CPF creates a copy of the source file in the target directory (the current working directory if you omit the target) and assigns the copy the filename of the source file. For example:

```
$ CPF MEMO /USER_1
```

copies the file *MEMO* from the current working directory to the target directory *USER_1*. Because CPF assigns the copy the name of the source file, the new file has the pathname */USER_1/MEMO*.

If you omit the target pathname entirely, CPF creates a copy of the source in the current working directory, unless the source file also resides there. In the previous example, since the source file *MEMO* is in the current working directory, CPF can't create another file named *MEMO* in the same directory. In this case, CPF displays the error message, "... can't copy a file or tree to itself" and does not make a copy.

By default, the system assigns the target file the default file ACLs of its parent directory (see Chapter 8). So, in the previous example, the system assigns the target file the default file ACLs of the directory *USER_1*.

To replace an existing file with a copy of another file, use the *-R* option as follows:

```
$ CPF /OWNER/JUNE_REPORT LATEST_REPORT -R
```

This command replaces the file *LATEST_REPORT* (in the current working directory) with a copy of *JUNE_REPORT*. As a result, *LATEST_REPORT* now contains a copy of *JUNE_REPORT*.

You can copy or replace several files using a single CPF command by either specifying multiple pairs of source and target pathnames (each pair separated by a space) or by using pathname wildcards. The following command uses pathname wildcards to copy all the files ending with *PLAN* to the current working directory:

```
$ CPF /OWNER/?*PLAN -LF
```

The *-LF* option directs the CPF command to list the name of each file it copies. For more information on using pathname wildcards, see Chapter 6.

Moving Files

When you *move* a file, you literally relocate the file in the naming tree. Use the **MVF (MOVE_FILE)** command the same way you use the CPF command described in the previous section. In fact, moving a file has the same effect as copying the file to another location and then deleting the original. Unlike a copy operation, however, when you move a file, it retains its original ACLs.

To move a file or group of files from one location in the naming tree to another, use the MVF command in the format:

```
MVF source [target] [options]
```

where *source* specifies the pathname of the file you want to move and *target* specifies the pathname of the file's new location in the

naming tree. The rules for pathnames described in Chapter 1 apply to both arguments.

The following command moves the file *FLOORPLAN*:

```
$ MVF /DESIGNER/FLOORPLAN /BUILDER/PLANS/CAPE
```

In this example, the target specifies the pathname for a nonexistent file named *CAPE*. The *MVF* command moves the file *FLOORPLAN* from the directory *DESIGNER* to the directory *BUILDER/PLANS* and names the file *CAPE*.

If the target pathname specifies a directory, *MVF* moves the source file into the target directory (or current working directory if you omit the target pathname). For example, the following command moves the file *FLOORPLAN* into the current working directory:

```
$ MVF /DESIGNER/FLOORPLAN
```

In this example, since no target filename was specified, the file retains the name of the source file (*FLOORPLAN*).

You can move a file to replace an existing file in another directory by using the *MVF* command with the *-R* option, as follows:

```
$ MVF /OWNER/REPORT LATEST_REPORT -R
```

This command replaces the contents of the file *LATEST_REPORT* (in the current working directory) with the contents of the file *REPORT* (in the directory */OWNER*).

To move several files in one operation, you can specify multiple pairs of source and target pathnames or use pathname wildcards. Chapter 6 describes how to use pathname wildcards.

Appending Files

To append the contents of one or more files to the end of another file, use the *CATF* (*CATENATE_FILE*) command in the following format:

```
CATF [source ... ] >>target
```

where *source* specifies the pathname of the file whose contents you want to append, and *target* specifies the pathname of the file to which you want to append. When you specify more than one source file, separate each file with a space. The system concatenates the source files and appends them to the target file.

The CATF command reads source files in order and normally writes them to standard output, which is, by default, the Shell's process transcript pad. The double right-angle brackets (>>) , however, redirect output from standard output and append the output to the target file. For example:

```
$ CATF MEMO_1 MEMO_4 >> PLAN_MEMOS
```

reads the files *MEMO_1* and *MEMO_4* in that order, and appends them to the file *PLAN_MEMOS*.

Chapter 6 provides more information on how to use I/O control characters.

Printing Files

To print one or more files, use the **PRF (PRINT_FILE)** command in the following format:

```
PRF [pathname ... ] [options]
```

where *pathname* specifies the name of the file you want to print. If you specify more than one file, separate each pathname with a space. The following example prints the file *MY_PLAN* on the printer named *SPIN*:

```
$ PRF MY_PLAN -PR SPIN
```

The PRF command itself doesn't actually print files; a server process, called **PRINT_SERVER (PRSVR)** does. (The PRSVR process runs on the node that is physically connected to the printer.) The PRF command queues a file for printing by copying the file to a directory, where it waits for PRSVR to get it and print it. By default, PRF queues files to the directory */SYS/PRINT/QUEUE*.

To see which files are queued for printing in the default queue directory (*/SYS/PRINT/QUEUE*), use the PRF command with the *-INTER[ACTIVE]* option. This option causes PRF to enter interactive mode, in which you can specify PRF commands and options interactively. For example, the following example lists all of the files queued to the printer named *SPIN*:

```
$ PRF -INTER
PRF> -PR SPIN
PRF> READ
```

For more information about the PRF command and its commands and options, see the *DOMAIN System Command Reference*.

If you normally use a printer connected to your node, */SYS/PRINT/QUEUE* is the name of the queue directory on your node. If a remote node controls the printers that you use by default, then */SYS/PRINT* is a link that your System Administrator creates to point to the */SYS/PRINT* directory on the remote node. This link causes PRF to queue files to the */SYS/PRINT/QUEUE* directory on the remote node by default. (The “Managing Links” section describes links in more detail.)

You can queue a file to the */SYS/PRINT/QUEUE* directory on another node by specifying the *-S* option along with the name of the node’s entry directory. For example:

```
$ PRF MY_PLAN -S //BOSTON
```

queues *MY_PLAN* to the */SYS/PRINT/QUEUE* directory on the remote node *BOSTON*.

Another option that you’ll find useful is the *-COP[IES]* option. This option lets you print multiple copies of a file, as shown in the following example:

```
$ PRF MY_PLAN -COP 16
```

This command prints 16 copies of the file *MY_PLAN*.

You can print multiple files using a single PRF command by either specifying multiple pathnames (each pathname separated by a space) or by using pathname wildcards. The following command uses path-

name wildcards to print any file in the current working directory that begins with *FILE* and ends with a one-digit number:

```
$ PRF FILE_[0-9]
```

This command, for example, will print *FILE_2* and *FILE_8* but not *FILE_A* or *FILE_B*.

Printing Files Using the Print Menu Interface

In addition to the PRF command, you can print files using the print menu interface shown in Figure 7-1. This menu allows you to specify print arguments and select various options without having to type them on the command line. The print menu interface is useful when you routinely specify several print options for each file you print. By using the menu interface, you can select all of the options once, and print several files without respecifying the options for each file you print.

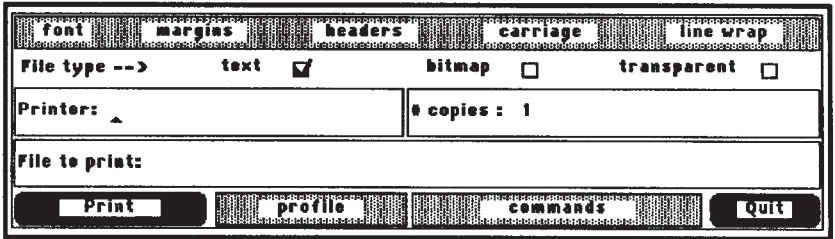

Figure 7-1. The Print Menu

To print files using the print menu interface, specify the PRFD (PRINT_FILE_DIALOG) command as follows:

```
$ PRFD
```

As shown in Figure 7-1, the PRFD command creates a special window pane at the top of the Shell process window displaying the print menu. The print menu is in control until you either print the file by selecting **Print**, quit the menu by selecting **Quit**, or select one of the

commands submenu items (we'll learn more about the **commands** submenu later in this section.)

To use the print menu, move the arrow cursor to the menu item you want to select; the system highlights the item name in reverse video. To select the item, press either the <F1> key, the space bar, or if you are using a mouse, the left mouse button (M1). (Hereafter, we use the term **select key** to refer to any of these keys.) You can also display help information about an item by moving the cursor over the item and pressing <HELP>.

To specify any of the **File type:** items (**text**, **bitmap**, or **transparent**), move the cursor over the item name. Once the item is highlighted, use the select key to select it, and a checkmark will appear as shown below:



For items that require you to type in specific information, such as **File to print:**, **printer:**, and **#copies:**, a small, triangular cursor appears in the item field. For example, to specify the pathname of the file you want to type, move the cursor to the line next to **File to print:** and press the select key. When the triangular cursor appears, type in the pathname as follows:

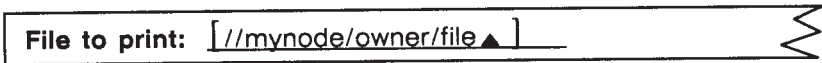

When you finish typing in the file's pathname, press <RETURN> and move to another item.

The items along the top row of the menu, and the **profile** and **commands** items on the bottom row, display *submenus* when you select them. These submenus allow you to select or specify additional print information. Use the submenu in the same way you use the main menu: either select an item, or type in the requested information. When you finish with a submenu, move the arrow cursor out of the submenu box, and it will close.

For example, when you select the **commands** item, the submenu shown in Figure 7-2 appears.

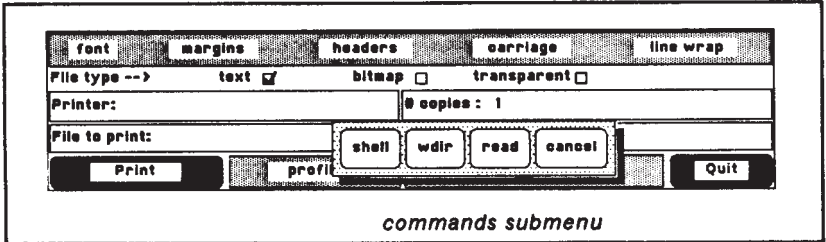

Figure 7-2. Print “Commands” Submenu

The **commands** submenu is very useful, because it allows you to perform specific operations outside of the print menu. For example, to return control to the Shell without quitting the print menu, you can select the **shell** submenu item. Table 7-3 describes the function of each item in the **commands** submenu.

When you’re satisfied with the selections you’ve made in the print menu, you can print the file by selecting **Print**. After you print a file, the menu maintains control and remains on the screen, enabling you to print additional files. The print menu remembers all of the submenu selections you’ve made for the previous file. To print another file using the same selections, specify a new file on the line next to **File to print:** and select **Print**. To exit the menu interface, select **Quit**.

Most of the selections in the print menu perform the same print functions as options on the command line. For more information on a specific menu or submenu item, refer to the description of its related PRF command option in the *DOMAIN System Command Reference*. Remember, you can get help information for any item by moving the cursor over the item and pressing the <HELP> key.

Table 7-3. Print “Commands” Submenu Items

Item	Description
shell	Returns control to the Shell. When you select shell , the dollar sign prompt appears in the Shell input window. To return control to the print menu again, type CTRL/Z .
wdir	Changes the current working directory to the specified directory. When you select wdir , a prompt appears in the Shell input window requesting a directory pathname. If you type <RETURN> without specifying a pathname, the system displays the current working directory.
read	Reads the queue directory and list the entries with the printer name specified by the printer item. If no printer name is specified, the system lists all the entries in the queue
cancel	Deletes the specified file from the queue. When you select cancel , a prompt appears in the Shell input window requesting the name of the file. If you type <RETURN> without specifying a filename, the system deletes the last file you queued.

Displaying File Attributes

To display a file’s attributes, such as its size, creation date, and access rights, to name a few, use the **LD (LIST_DIRECTORY)** command in the following format:

LD pathname... [-options]

where *pathname* specifies the pathname of the file, and *options* specifies which attributes you want displayed.

The LD command in the following example displays attribute information for the file *MEMO*, as shown in Figure 7-3. The command specifies two attribute options: *-R*, which displays the file's access rights, and *-DTC*, which displays the file's creation date and time.

```
$ LD //NODE/USER/MEMO -R -DTC
```

rights	date/time created	name
pgndcalr	85/01/04.09:16	//node/user/memo

1 entries, 2 blocks used.

Figure 7-3. Sample Display Showing File Attributes

To display an entire set of attributes for a file, use the *-A* option as follows:

```
$ LD //NODE/USER/MEMO -A
```

You can display the attributes of several files by either specifying multiple file pathnames, (each pathname separated by a space) or by using pathname wildcards. The command in the following example uses the question mark (?) and asterisk (*) pathname wildcards to display attribute information for all files in the current working directory that have the suffix, *_PLAN*:

```
$ LD ?*_PLAN -R -DTC
```

You can also display the attributes of all the files in a particular directory by specifying the name of the directory as the pathname argument. The “Displaying Directory Information” section describes how to use LD to list the contents of a directory and display attribute information about its contents.

Deleting Files

To delete one or more files, use the **DLF** (**DELETE_FILE**) command in the following format:

```
DLF [pathname ... ] [options]
```

where *pathname* specifies the pathname of the file you want to delete. If you specify multiple pathnames to delete multiple files, separate each pathname with a space.

The following command deletes the files *MY_PLAN* and *REPORT* from the current working directory:

```
$ DLF MY_PLAN REPORT
```

You can also use pathname wildcards to delete related groups of files. For example:

```
$ DLF %.BAK -L
```

The percent sign (%) wildcard character causes **DLF** to delete all of the files in the current working directory that end in *.BAK*. The *-L* option lists each file as **DLF** deletes it.

DLF is an example of a command that queries you to verify names that you specify with pathname wildcards. In the previous example, the **DLF** command asks you to verify the deletion of each file that matches the pathname *%.BAK*.

Copying the Display to a File

You can copy the image of your current display to a file using the **CPSCR** (**COPY_SCREEN**) command in the following format:

```
CPSCR path name [-INV]
```

where *pathname* specifies the pathname of the file to which you want to copy the display image. The *-INV* option directs **CPSCR** to store the file in reverse video (black on white or white on black depending on the current display setting).

To print a file that contains a screen image, use the PRF command with the *-PLOT* option.

Comparing ASCII Files

To identify differences between ASCII text files, use the **CMF** (**COMPARE_FILE**) command in the following format:

```
CMF source [target ... ] [-options]
```

where *source* specifies the pathname of the file to which CMF compares one or more *target* files; CMF reports all differences in relation to the source file. If you specify multiple target pathnames, separate them with spaces. If you omit a target pathname, CMF compares the source with text from standard input.

The CMF command in Figure 7-4 compares the contents of the file *SPEECH* to the contents of *SPEECH.BAK*.

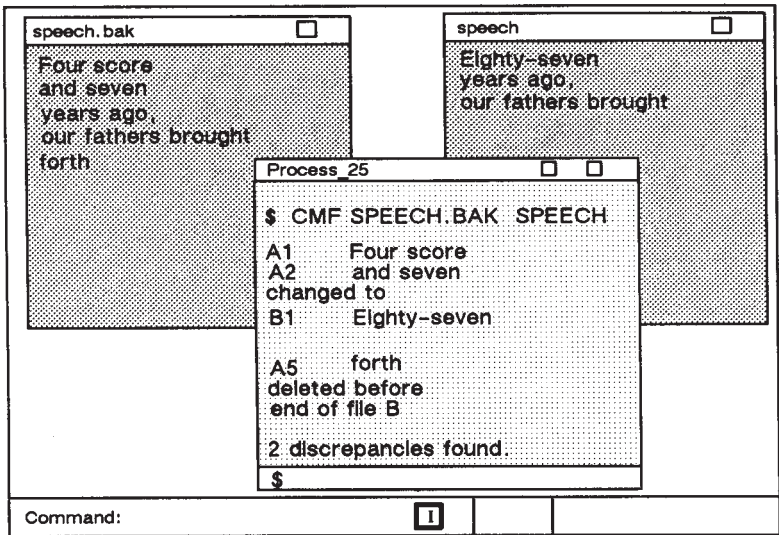

Figure 7-4. Comparing Two ASCII Files

Managing Directories

Directories are the naming tree components that contain other objects. Table 7-4 summarizes the commands for managing directories.

Table 7-4. Commands for Managing Directories

Task	Shell Command
Create a directory	CRD pathname
Rename a directory	CHN old_name [new_name]
Copy a directory tree	CPT source [target]
Replace a directory tree	CPT source [target] -R
Merge directory trees	CPT source [target] -MS
Compare directory trees	CMT source target
Display contents of a directory	LD [pathname]
Delete a directory tree	DLT pathname

Creating Directories

Each directory that you create is actually a subdirectory of its parent directory (the directory above it in the naming tree). To create a directory, specify the **CRD (CREATE_DIRECTORY)** command in the following format:

```
CRD pathname ...
```

where *pathname* specifies the pathname of the directory you want to create. If you specify multiple pathnames to create multiple directories, separate each pathname with a space. The following command creates a directory named *REPORTS*:

```
$ CRD /OWNER/REPORTS
```

The CRD command creates the directory *REPORTS* as a subdirectory of the parent directory */OWNER*. The new directory, (*REPORTS*) also receives an initial set of ACLs from the initial directory ACLs of the parent directory (*/OWNER*). You can change the initial ACLs with the EDACL command. Chapter 8 explains ACLs and describes how to use the EDACL command.

Renaming Directories

To change the name of a directory, use the **CHN (CHANGE_NAME)** command in the following format:

```
CHN old_name [new_name] [options]
```

where *old_name* specifies the pathname of the directory you want to rename, and *new_name* specifies the new name of the directory. For example:

```
$ CHN /OWNER/REPORTS PROGRESS
```

changes the name of the directory *REPORTS* to *PROGRESS*. Notice that the *new_name* argument applies to the rightmost component (*REPORTS*) of the *old_name* argument. You cannot use CHN to change the name of a directory embedded in a pathname.

To append a naming suffix to the new directory name, specify any of the following naming options:

Option	Description
-D	Appends the current month and day to the new name (<i>new_name.mm.dd</i>).
-Y	Appends the current year, month, and date to the new name (<i>new_name.yy.mm.dd</i>).
-U	Forces the system to create a unique new name by appending a sequence of number(s) to the end of the name.

If you omit the *new_name* argument, you must specify one of the options in the previous list; the system creates a new name by copying the *old_name* and appending the proper suffix as shown here:

```
$ CHN /OWNER/REPORTS -D
```

This command changes the name of the directory *REPORTS* to *REPORTS.06.16*.

Copying Directory Trees

A directory and all of the objects it contains is called a directory tree. A directory tree represents the part of a naming tree that extends from a specific directory through all its files, subdirectories, and links as shown in Figure 7-5.

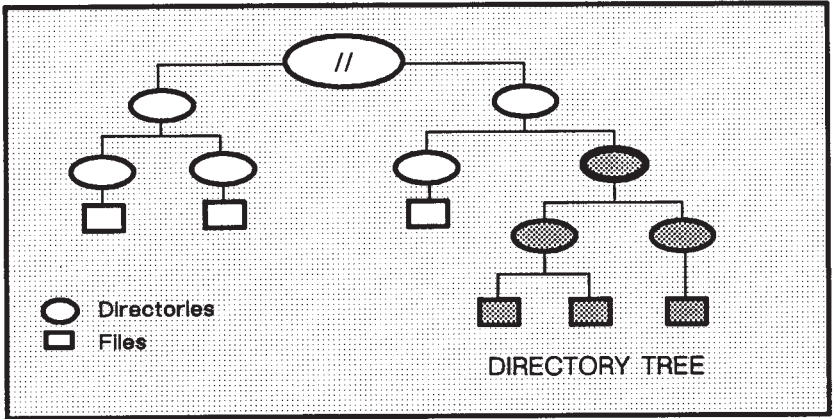

Figure 7-5. Sample Directory Tree

To copy a directory tree to another location, use the **CPT (COPY_TREE)** command in the following format:

CPT source target

where *source* specifies the pathname of the directory you want to copy and *target* specifies the pathname of the naming tree location where you want the copy created. The rules for pathnames described in Chapter 1 apply to both command arguments.

Figure 7-6 illustrates how the CPT command in the following example copies a directory tree.

\$ CPT REPORTS //BOSTON/USER_1/PROG -L

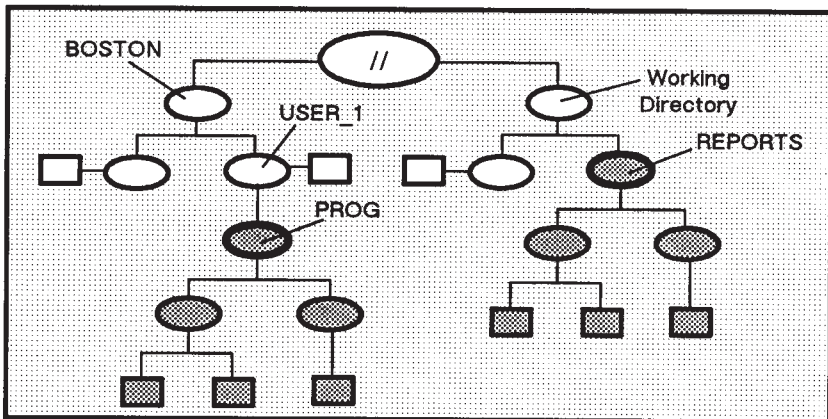
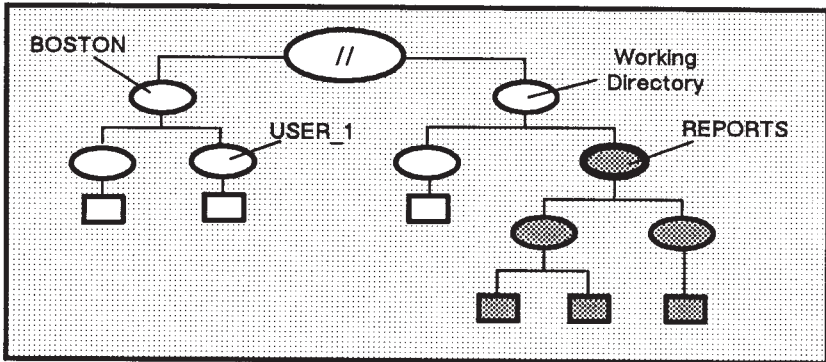

Figure 7-6. Copying a Directory Tree

The CPT command creates a copy of the directory tree *REPORTS* and names the copy *PROG*. CPT creates the copy in the directory *USER_1*. The *-L* option lists the name of each object as it is copied.

Replacing Directory Trees

To replace one directory tree with another directory tree, specify the `-R` option with the **CPT (COPY_TREE)** command described in the previous section. The `-R` option directs CPT to delete the directory tree specified by the target pathname and to create a copy of the source tree in its place. Figure 7-7 illustrates how the following command replaces a directory tree.

```
$ CPT REPORTS //BOSTON/USER_1 -R
```

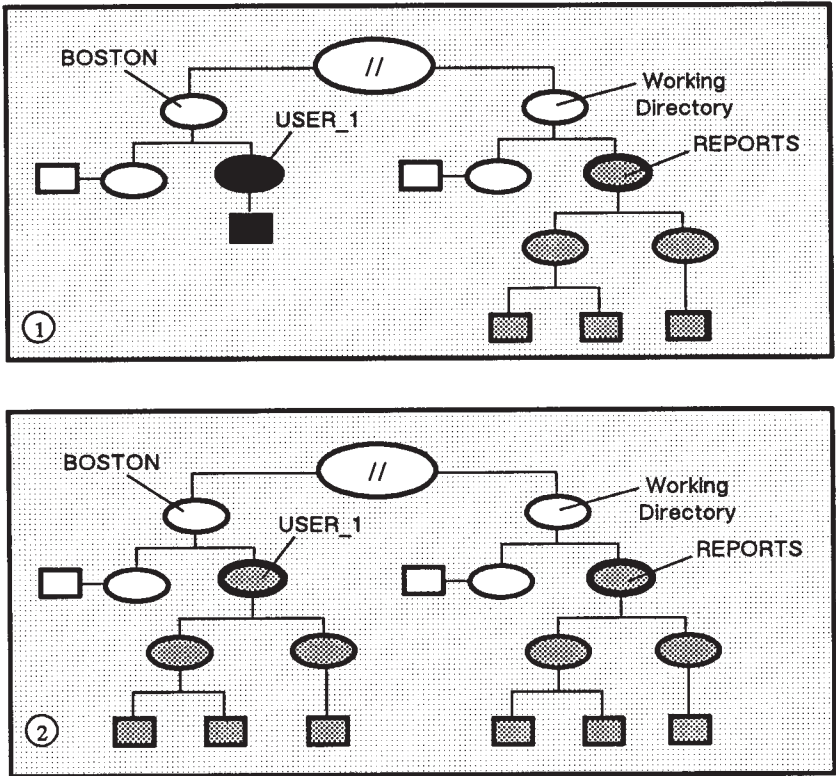

Figure 7-7. Replacing a Directory Tree

The CPT command in Figure 7-7 does the following:

1. Deletes the target tree starting at the pathname *//BOSTON/USER_1*.
2. Replaces the target tree with a copy of the entire *REPORTS* directory tree.

Merging Directory Trees

You can merge directory trees using either the *-MS* or *-MD* option with the **CPT (COPY_TREE)** command described in the “Copying Directory Trees” section discussed earlier. When merging directory trees, CPT first compares the source and target directories object by object. It then merges the directories according to the option you specified.

When you specify the *-MS* option, CPT uses the following process to merge the source directory with the target directory:

- Objects that exist in the source but not in the target are created in the target.
- Objects that exist in the target but not in the source remain unchanged.
- Files and links with the same name in both the source and target are deleted from the target and replaced by the source version.
- Directories with the same name in both source and target are merged.

The CPT command continues this process until it reaches the end of the source tree.

The following command merges the source directory *PROGRESS* with the target directory *REPORTS*.

```
$ CPT //BOSTON/USER_1 /PROGRESS REPORTS @
$_ -MD -L
```

The *-L* option directs CPT to list all objects that it creates in the target directory.

If you specify the *-MD* option, the merging process is similar to that of *-MS*; however, files and links with the same name in the source and target are left unchanged in the target.

Comparing Directory Trees

To compare the contents of one directory tree to another, use the **CMT** (**COMPARE_TREE**) command in the following format:

CMT source target [options]

CMT compares all of the objects in the *source* directory tree against all the objects in the *target* directory tree. CMT reports the following:

- Any objects that appear in both the source and target but whose contents are different.
- Any objects that appear in the source but not in the target. If the target contains objects that do not appear in the source, CMT ignores the differences.

For example, let's assume that directories *DIR_1* and *DIR_2* contain the following files:

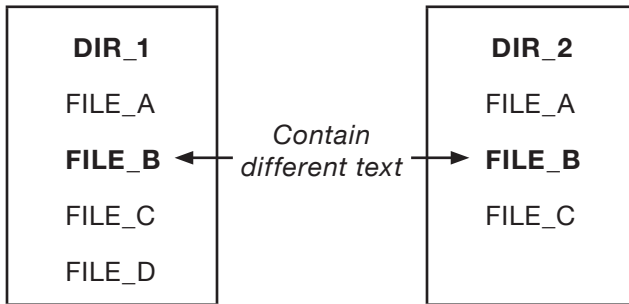

Let's also assume that the contents of all the files in *DIR_1* and *DIR_2* are identical, except for *FILE_B* which contains different

text. Figure 7-8 illustrates how the CMT command compares the files in *DIR_1* against those in *DIR_2*.

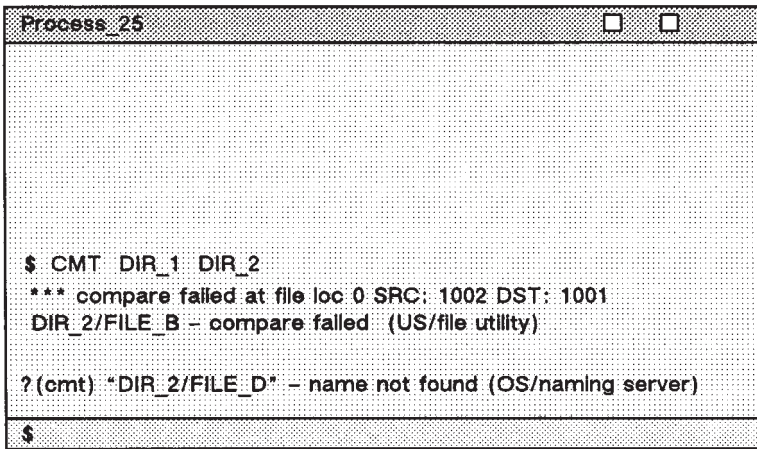

```
Process_25
$ CMT DIR_1 DIR_2
*** compare failed at file loc 0 SRC: 1002 DST: 1001
DIR_2/FILE_B - compare failed (US/file utility)

?(cmt) "DIR_2/FILE_D" - name not found (OS/naming server)
$
```

Figure 7-8. Comparing Directory Trees

Notice in Figure 7-8 that the first message reports a difference between the contents of each directory's *FILE_B*. The second message reports that *FILE_D* in *DIR_1* did not appear in *DIR_2*.

Displaying Directory Information

To list the contents of a directory and report information about the objects the directory contains, specify the **LD (LIST_DIRECTORY)** command in the following format:

```
LD [pathname ... ] [options]
```

where *pathname* specifies the pathname of the directory, and *options* specifies the types of information you want LD to report about the objects it lists. If you omit the *pathname* argument, LD lists the contents of the current working directory.

The command in the following example lists the contents of the directory *REPORTS*; the options direct LD to report each object's

creation date and time, system object type, and rights (ACLs). Figure 7-9 shows a sample display produced by the following LD command:

```
$ LD /OWNER/REPORTS -DTC -ST -R
```

Directory "/owner/reports":

sys type	rights	date/time created	name
dir	pgndcalr	85/01/04.09:16	april
dir	pgndcalr	85/01/04.09:16	july
dir	pgndcalr	85/01/04.09:16	june
dir	pgndcalr	85/01/04.09:16	may
file	pgndwrx	85/01/04.09:18	procedure
link			progress
file	pgndwrx	85/01/04.09:16	sample
file	pgndwrx	85/01/04.09:18	template

8 entries, 7 blocks used.

Figure 7-9. Sample Directory Display

To list the contents of an entire directory tree, specify the ellipsis wildcard (...) as part of the pathname argument. For example:

```
$ LD /OWNER/...
```

This command lists the contents of the directory *OWNER*, as well as the contents of all its subdirectories.

You can also use LD to report information about specific files by specifying the pathname of the file as an argument. The “Displaying File Attributes” section discussed earlier describes how to use LD to report file information.

Deleting Directory Trees

To delete a directory tree, use the **DLT (DELETE_TREE)** command in the following format:

DLT *pathname* ...

where *pathname* specifies the pathname of the directory you want to delete.

NOTE: The pathname you specify does not have to be a directory. If you specify the pathname of a file or link, DLT will delete the object with no warning message. To delete files, use the **DLF (DELETE_FILE)** command; to delete links, use the **DLL (DELETE_LINK)** command.

The DLT command deletes the specified directory and all of the objects it contains. For example, the following command deletes the directory tree shown in Figure 7-10:

```
$ DLT REPORTS -L
```

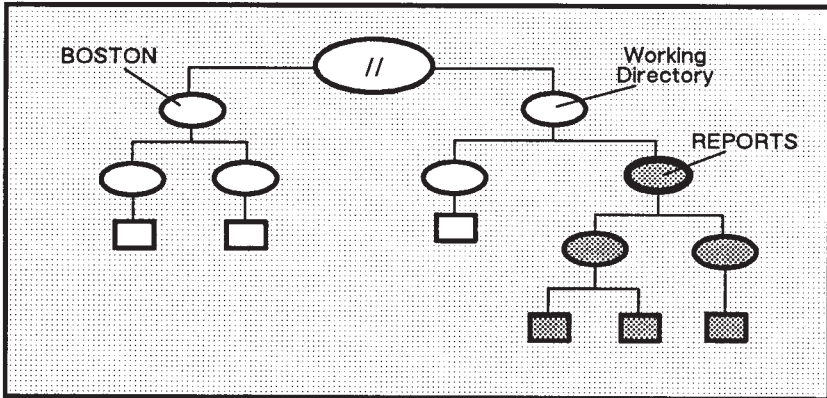

Figure 7-10. Deleting a Directory Tree

The command in the previous example deletes the directory tree starting at the directory *REPORTS* in the current working directory. The *-L* option directs DLT to list each object it deletes.

Managing Links

As you use the system, you may find that many of the files and directories that you access frequently have unusually long pathnames. You can eliminate the inconvenience of typing a lengthy pathname by creating a shorthand name for the object, called a **link**.

A link is a special object that contains the name of another object. When you specify a link as a pathname or part of a pathname, the system substitutes the pathname that the link contains (the *resolution name*) for the name of the link.

This section describes how to manage links on your system. Table 7-5 summarizes the commands used to manage links.

Table 7-5. Commands for Managing Links

Task	Shell Command
Create a link	CRL link_name object_name
Display link resolution names	LD [pathname] -LL -LT
Redefine a link	CRL link_name Object_name -R
Rename a link	CHN old_name [new_name]
Copy a link	CPL source [target]
Delete a link	DLL link_name

Creating Links

To create a link, specify the **CRL (CREATE_LINK)** command in the following format:

```
CRL link_name object_name
```

where *link_name* specifies the pathname of the link, and *object_name* specifies the pathname of the object to which the link points. The rules for pathnames described in Chapter 1 apply to both arguments.

The following command creates a link:

```
$ CRL REPORTS /OWNER/APRIL/PROGRESS_REPORTS
```

The command in this example creates a link named *REPORTS* in the process's current working directory. The link contains the pathname for the subdirectory *PROGRESS_REPORTS*. As shown in the following example, when you specify *REPORTS* as a pathname or part of a pathname, the system substitutes the pathname */OWNER/APRIL/PROJECT_REPORTS*. For example, instead of specifying

```
$ DLF /OWNER/APRIL/PROGRESS_REPORTS/MR_JONES
```

to delete the file *MR_JONES*, you could specify

```
$ DLF REPORTS/MR_JONES
```

You can also use the CRL command to create more than one link by specifying link_name/object_name pairs as shown below:

```
$ CRL BUGS /MAINTENANCE/REPORTS STARTS /SYS/DM
```

| pair | pair

This command creates two links: *BUGS* and *STARTS*.

Displaying Link Resolution Names

To display the resolution names for all the links listed in a particular directory, use the **LD (LIST_DIRECTORY)** command in the following format:

```
LD pathname -LT [-LL]
```

where *pathname* specifies the pathname of the directory that contains the link, and *-LT* directs LD to display the resolution name of each link. Normally, LD lists all the objects in the directory, including files and subdirectories. The *-LL* option directs LD to list only the links.

The command in the following example displays the link resolution names for all links in the node entry directory, as shown in Figure 7-11:

```
$ LD / -LT -LL  
  
BUGS           “/maintenance/reports”  
STARTS        “/sys/dm”  
NEWS          “//my_boss/owner/project/status”  
  
30 entries, 3 listed.
```

Figure 7-11. Sample Display of Link Resolution Names

Redefining Links

You can redefine an existing link by changing its link resolution name. To redefine a link, use the *-R* option with the **CRL (CREATE_LINK)** command as follows:

```
$ CRL REPORTS /OWNER/MAY/PROGRESS_REPORTS -R
```

This command replaces the object name for the existing link *REPORTS* that we created in the “Creating Links” section discussed earlier. Notice that the new link name points to the subdirectory *MAY* instead of *APRIL*.

Renaming Links

To change the name of a link, use the **CHN** (**CHANGE_NAME**) command in the following format:

```
CHN old_name [new_name] [options]
```

where *old_name* specifies the pathname of the link you want to rename, and *new_name* specifies the new name of the link. For example, the command:

```
$ CHN REPORTS PROGRESS
```

changes the name of the link *REPORTS*, in the current working directory, to *PROGRESS*.

You can specify any of the following naming options with the CHN command:

Option	Description
-D	Appends the current month and day to the new name (new_name.mm.dd).
-Y	Appends the current year, month, and date to the new name (new_name.yy.mm.dd).
-U	Forces the system to create a unique new name by appending a sequence of number(s) to the end of the name.

If you omit the *new_name* argument, you must specify one of the options in the previous list; the system creates a new name by copying the *old_name* and appending the proper suffix as shown here:

```
$ CHN REPORTS -U
```

This command changes the name of the link *REPORTS* to *REPORTS.1*.

Copying Links

Copying links is basically the same as copying files; when you *copy* a link, you create a copy of the link in another location in the naming tree. To copy a link, use the **CPL (COPY_LINK)** command in the following format:

```
CPL source [target ...] [option]
```

where *source* specifies the pathname of the link you want to copy, and *target* specifies the naming tree location where you want the copy created. The rules for pathnames described in Chapter 1 apply to both command arguments.

The CPL command always creates a copy of the source link at the location specified by the target. For example:

```
$ CPL REPORTS /USER_1/STATUS
```

creates a copy of the source link *REPORTS* in the directory *USER_1*. And, since the target specifies the pathname of a link, CPL assigns the copy the name specified by the target, which in this example is *STATUS*.

If the target specifies the pathname of a directory, CPL creates a copy of the source link in the target directory (the current working directory if you omit the target) and assigns the copy the name of the source link. For example:

```
$ CPL REPORTS /USER_1
```

copies the link *REPORTS* from the current directory to the target directory *USER_1*. Because CPL assigns the copy the name of the source link, the new link has the pathname */USER_1/REPORTS*.

To replace an existing link with a copy of another link, use the *-R* option as follows:

```
$ CPL REPORTS /USER_2/PROGRESS -R
```

This command replaces the link *PROGRESS* with a copy of the link *REPORTS* (from the current working directory).

You can copy or replace several links using a single CPL command by either specifying multiple pairs of source and target pathnames (each pair separated by a space) or by using pathname wildcards. The following command copies all of the links in the current working directory to the directory */USER_2*.

```
$ CPL ?* /USER_2/MY=
```

The wildcards (?) that make up the source pathname direct CPL to copy all links in the current working directory. The wildcard (=) in the target pathname directs CPL to derive the name of each new link from the source link names. For example, the link *REPORTS* becomes *MYREPORTS* in the target directory.

Deleting Links

To delete one or more links, use the **DLL (DELETE_LINK)** command in the following format:

```
DLL [link_name ...] [options]
```

where *link_name* specifies the pathname of the link you want to delete. If you specify multiple pathnames to delete multiple links, separate each pathname with a space.

The following command deletes the link *REPORTS* from the current working directory:

```
$ DLL REPORTS
```

You can also use pathname wildcards to delete related groups of links. For example:

```
$ DLL /.../STATUS
```

The ellipsis wildcard (...) directs the DLL command to delete every link named *STATUS* in all directories subordinate to the node entry directory.

Controlling Access to Files and Directories

You can protect your files and directories from unauthorized use with a system protection mechanism called an **access control list (ACL)**. Every file and directory in the system has an access control list that defines:

- Who can use the object
- What operations these users can perform on the object

An ACL for a file, for example, can authorize some users to read the file, and permit others to edit it.

This chapter describes the following ACL topics:

- The structure of an ACL and its component parts
- How the system assigns initial ACLs to objects
- How you can use Shell commands to display, edit, and copy ACLs
- Protected subsystems and the commands you use to create and use them

ACL Structure

The ACL for each file and directory contains one or more ACL entries. An **entry** describes the operations a user or set of users can perform on the object. For a file, the ACL can also contain an indicator that it belongs to a **protected subsystem**. (We describe protected subsystems in the “Protected Subsystems” section.)

Each ACL entry consists of two elements: a **subject identifier (SID)** specification and a set of **access rights**. Figure 8-1 shows the elements that make up an ACL entry.

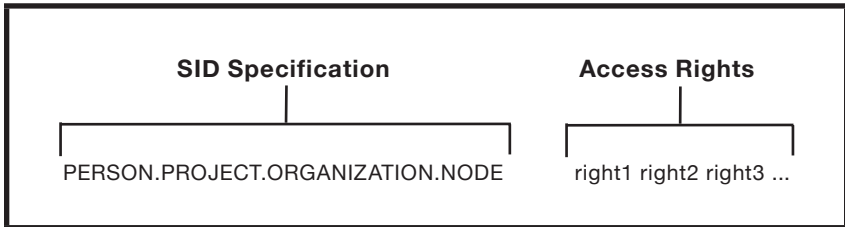

Figure 8-1. Structure of an ACL Entry

The SID specification identifies a specific user or group of users. The access rights define what operations that user or group can perform on the object. Let’s take a closer look at these two elements to see how the system uses them to control access to an object.

The Subject Identifier (SID)

As described in Chapter 4, the system associates each user process with a SID that identifies the owner of the process. Like the SID specification in an ACL entry, the SID assigned to a user process has the following format:

PERSON.PROJECT.ORGANIZATION.NODE

The SID consists of four fields: **username**, **project**, **organization**, and **node** (abbreviated **ppon**). (The node field specifies the hexadecimal node ID of the node on which the user is logged in). When you log in, the system gathers SID information for your account. Then, each time you create a process, the system assigns the same SID to it to identify you as the owner.

When a user requests access to a file or directory, the system checks the object's ACL. Specifically, the system searches for an ACL entry whose SID matches the SID of the user's process. If the system doesn't find a match, it denies the user access to the object. If the system does find a match, it grants the user the set of rights specified by the ACL entry. (The "Access Rights" section describes the meaning of the various access rights.)

Figure 8-2 shows a set of two ACL entries for a file.

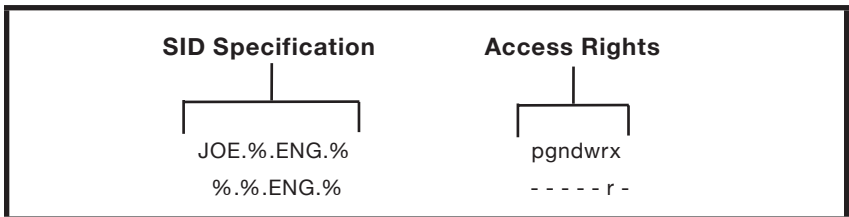

Figure 8-2. Sample ACL Entries

The percent signs (%) that appear in the different fields of the SID specification are wildcards. Wildcards match any name in the network with a specific SID field. For example, the SID for the second ACL entry in Figure 8-2 (%%.ENG%) contains wildcards in the

PERSON, *PROJECT*, and *NODE* fields. These wildcards match any name in the corresponding fields of a user's process SID. As a result, the ACL entry for *%.%.ENG.%* matches any process SID with the organization name *ENG*.

When a user process requests access to an object, the system starts its search for a matching SID at the most specific SID specification and continues searching toward the most general. As soon as the system finds a specification that matches the process's SID, it stops the search and grants the rights listed in that ACL entry.

For example, the SID specification for the first ACL entry in Figure 8-2 (*JOE%.ENG.%*) is more specific than that of the second entry (*JOE* is a specific person in the organization *ENG*). Suppose a process with the SID *JOE.BRIDGE.ENG.1E07* tries to access the object. In this case, the SIDs for both ACL entries match the process SID. However, since the system matched the more specific SID (*JOE%.ENG.%*) first, it grants the process the associated rights (*pgndwrx*).

Access Rights

Access rights specify what operations, such as read, write, execute, and delete, a user process can perform on a particular file or directory. Table 8-1 lists the access rights for files and directories.

For example, the following ACL entry for a file grants the specified set of access rights to all users:

```
%.%.%.%          - - - - wrx
```

In this example, the *wrx* specification indicates that the file has *WRITE* (*w*), *READ* (*r*), and *EXECUTE* (*x*) rights. Notice the four hyphens that precede *wrx* rights. When you list the ACL entries for an object (see the "Displaying ACLs" section) the system displays the hyphens to represent access rights that are not valid (denied) for the entry. In the previous example, the entry denies *p*, *g*, *n*, and *d* rights (represented by hyphens) and grants *w*, *r*, and *x* rights.

As you'll see later in this chapter, you can also deny certain users any access to an object. For example:

```
%.BRIDGE.ENG.%    pgndwrx  
%.%.ENG.%        -----
```

This ACL denies every user in the *ENG* group access to the file, except those working on the *BRIDGE* project.

As shown in Table 8-1, the types of access for directories are different than those for files. While *PROTECT (P)*, *GRANT (G)*, and *NODE (N)*, have the same meaning for files and directories, *DELETE (D)* and *READ (R)* have different meanings. In addition, *WRITE (W)* and *EXECUTE (X)* access apply only to files; *CHANGE (C)*, *LINKS (L)*, *ADD (A)*, *SEARCH (S)*, and *EXPUNGE (E)* rights apply only to directories.

Table 8-1. Access Rights for Files and Directories

Access Right	Abbrev.	Meaning for Directories	Meaning for Files
Protect	P	Change the object's ACLs.	
Grant	G	Grant any subset of your rights to other users.	
Node	N	Change the nodes from which users can access objects.	
Delete	D	Delete the directory. (See note below.)	Delete the file.
Read	R	List entries.	Read the file.
Write	W	None.	Write to the file.
Execute	X	None.	Execute object file.
Change	C	Change names and delete links.	None.
Links	L	Add links	None.
Add	A	Add files and subdirectories.	None.
Search	S	Access subdirectories and subdirectory objects.	None.
Expunge	E	Delete subdirectories and subdirectory objects.	None.

Note: To delete a directory tree, you need directory delete rights, directory expunge rights (see “Understanding Search and Expunge Rights” section), directory change rights (if the directory contains links), and file delete rights (if the directory contains files).

Understanding SEARCH and EXPUNGE Rights

To access an object, in addition to appropriate rights to the object, you must have appropriate rights to the object's parent directory. To access an object, its parent must grant you *SEARCH* (*S*) rights. To delete an object, its parent must grant you *EXPUNGE* (*E*) rights. Consider the following example:

```
$ LD /OWNER/REPORTS
```

In order to list the contents of *REPORTS*, you must have *S* rights to its parent directory */OWNER*, as well as *R* rights to *REPORTS*. Similarly, to delete the subdirectory *REPORTS*, you need *E* rights to */OWNER*, as well as *D* rights to *REPORTS*.

If *REPORTS* contains additional objects, you need *E* rights to *REPORTS* to delete them. Therefore, to delete a directory tree, you must have *E* rights to the parent directory and all of its subdirectories except the subdirectories at the very bottom of the tree.

For reasons of compatibility, the system, by default, assigns *S* and *E* rights to all ACL entries for directories. In addition, if the directory ACL does not contain a *%.%.%.%* entry, the system adds the following entry by default whenever the object is accessed:

```
%.%.%.%          - - - - - SE
```

Since both DOMAIN software and user-supplied software depend on these rights, you should always leave *S* and *E* rights on. To deny *S* and *E* rights, you must explicitly delete them from the entry.

Managing ACLs

By default, the system assigns an ACL to every file or directory that you create. (The "Initial ACLs" section describes how the system assigns ACLs to objects.) You can display, edit, and copy an object's ACL using the following Shell commands:

- **ACL** displays and copies ACLs.
- **EDACL** displays and edits ACLs.

The following sections describe how you use these commands.

Displaying ACLs

To display an object's ACL, use the Shell command **ACL** (**ACCESS_CONTROL_LIST**) in the following format:

ACL *pathname*

where *pathname* specifies the pathname of the object whose ACL you want to list. For example:

```
$ ACL /OWNER/REPORT
```

This command lists the ACL entries for the file *REPORT*. Figure 8-3 shows a sample display produced by this command.

ACL for report:	
%.%.%.%	- - - - - r -
%.%.ENG.%	pgndwrx
%.%.MRKT.%	pgndwrx

Figure 8-3. Sample ACL Display

By using pathname wildcards (see Chapter 6), you can list the ACLs for a specific group of objects. For example, the following command lists the ACLs for all the files in the current working directory that have the suffix *.BIN*:

```
$ ACL ?*.BIN
```

You can also display the ACL for an object using the **EDACL** (**EDIT_ACCESS_CONTROL_LIST**) command as follows:

```
$ EDACL /OWNER/REPORT -L
```

The next section, “Editing ACLs,” provides more information on how to use the EDACL command to display and edit ACLs.

Editing ACLs

You can edit an object's ACL using the Shell command **EDACL** (**EDIT_ACCESS_CONTROL_LIST**). The EDACL command allows you to display, add, change, and delete ACL entries. You can also use the EDACL command to edit a directory's initial ACLs. (The "Editing Initial ACLs" section describes how to use the EDACL command to edit initial ACLs).

Like most Shell commands, you can direct EDACL to perform specific operations by specifying options on the command line. In addition to its command options, the EDACL command also accepts a special set of ACL editing commands. The way you specify these editing commands depends on the mode in which EDACL operates.

The EDACL command operates in two modes: **command line mode** and **interactive mode**. In command line mode, you specify editing commands as options on the command line. For example, EDACL in the following example uses the editing command *-L* to display the ACL for the file *REPORT*:

```
$ EDACL REPORT -L
```

If you specify the EDACL command without any editing commands on the command line, EDACL enters interactive mode and prompts you for editing commands. When you specify editing commands in interactive mode, *do not precede the command with a hyphen (-)*. For example:

```
$ EDACL REPORT
report
* L <RETURN>
```

In this example, since no editing commands appear on the EDACL command line, EDACL enters interactive mode. Specifying the *L* command (without a hyphen) at the asterisk (*) prompt directs EDACL to list the ACL entries for *REPORT*.

Once you enter interactive mode, you can continue to specify EDACL editing commands to perform a series of edit operations. To exit interactive mode and save the changes you've made, type

CTRL/Z. The Q command quits interactive mode without saving your changes.

You can edit the ACLs of several objects either by specifying multiple pathnames (separating each pathname with a space) or by using pathname wildcards. Chapter 6 describes how to use pathname wildcards.

This section describes how to use the EDACL command to list and edit ACLs. The examples presented in this section show how to use EDACL commands in command line mode. For a complete description of EDACL, see the *DOMAIN System Command Reference*.

Table 8-2 summarizes the commands used to edit ACLs.

Table 8-2. Summary of Commands for Editing ACLs

Task	Command
Display an object's ACL	EDACL pathname -L
Add an ACL entry	EDACL pathname -A ppon rights
Add rights to an ACL entry	EDACL pathname -AR ppon rights
Change access rights for an ACL entry.	EDACL pathname -C ppon rights
Delete rights from an ACL entry	EDACL pathname -DR ppon rights
Delete an ACL entry	EDACL pathname -D ppon rights

Rules to Specify ACL Entries

Most of the EDACL commands described in this section require you to specify SID and access right information. For example, to add an ACL entry, you must specify a SID and a set of access rights. Before you attempt to use EDACL commands, you should understand the rules for specifying SIDs and access rights.

When you specify a SID, you can use the percent sign (%) wildcard character in each field to match any name in the corresponding field of a process SID. For example, the following SID matches any process SID in the system with the username JOE:

JOE.%.%.%

When you specify a SID that uses % wildcards, you may omit trailing % wildcards and the periods that separate them. For example, the following SID specifications are the same:

JOE.%.%.%

JOE.%

JOE

Table 8-3 lists the access rights that you can specify for files and directories. Remember, directories and files have their own unique set of access rights. You cannot specify file rights for a directory or directory rights for a file.

To specify access rights individually, use the one-letter abbreviations listed in Table 8-3. For example:

```
$ EDACL REPORT -A JOE RW  
                        |  
                        Access rights
```

The command in this example specifies the *READ (R)* and *WRITE (W)* access rights for the file *REPORT*.

To deny rights (grant no rights) for an entry, specify a hyphen character (-) as follows:

\$ EDACL REPORT -A JOE -
└─┘
No access rights

Table 8-3. Valid Rights for Files and Directories

FILES	DIRECTORIES
P Protect	P Protect
G Grant	G Grant
N Node	N Node
D Delete	C Change
R Read	A Add files and subdirectories
W Write	L Add links
X Execute	D Delete
	R Read
	S Search
	E Expunge

You can also use any of the special class names in Table 8-4 to specify a set of commonly used rights. For example:

```
$ EDACL REPORT -A JOE -USER
                        |
                        v
                    Class name
```

The *-USER* class name in this example specifies a set of rights that you commonly grant to other users on the system. For both files and directories, *-USER* grants all rights to the object except the ability to change the object's ACL. Since the object in this example is a file, *-USER* grants DELETE (D), WRITE (W), READ (R), and EXECUTE (X) access.

NOTE: EDACL will not allow you to perform an operation that restricts everyone from changing an ACL. At least one user must have the right *PROTECT (P)* to change the ACL.

System users with the project name *BACKUP* may create back-up copies of files and directories on magnetic tape. Users with the project name *BACKUP* need *READ (R)* access to files and directories. EDACL issues a warning when you change an ACL in a way that denies *BACKUP* access; however, EDACL does make the change. You should ignore the warning only if the object(s) does not require back-up copies. If the object does require back-up copies, edit the ACL again and add an entry that grants the *BACKUP* project (*%.BACKUP.%.%*) *READ (R)* access. The next section, "Adding ACL Entries," describes how to add an ACL entry.

Table 8-4. Class Names for Commonly Assigned Rights

Name	Meaning	Directories	Files
-OWNER	All rights.	PGNDCALRSE	PGNDRWX
-USER	All rights except the ability to change ACL.	DCALRSE	DWRX
-READ	File read access.	Not allowed	R
-EXEC	File read access. Execute access to object files.	Not allowed	RX
-LDIR	List directory. Search and expunge the directory's subdirectories.	RSE	Not allowed
-ADIR	List directory and add entries. Search and expunge the directory's subdirectories.	ALRSE	Not allowed
-NONE	Grants no rights except Sand E. (denies access).	SE	None

Adding ACL Entries

To add an entry (SID and rights) to an ACL, use the **-A** command in the following format:

```
EDACL pathname ... -A ppon rights
```

where *ppon* specifies the SID for the new entry and *rights* specifies the set of access rights. The **-A** command directs EDACL to add the specified SID and access rights to the ACL. For example:

```
$ EDACL REPORT -A %%.MAN -OWNER
```

The command in this example adds a new ACL entry to the ACL for the file *REPORT*. The **-OWNER** rights class name (see Table 8-4) specifies a full set of rights for the entry. The new entry grants full access (pgndrwx) to anyone in the organization named *MAN*. Notice that the SID specification in this example omits the trailing *%* wildcard for the *NODE* field.

Changing Entry Rights

To change the access rights for an existing ACL entry, use the **-C** command in the following format:

```
EDACL pathname ... -C ppon rights
```

where *ppon* specifies the SID for the entry you want to change, and *rights* specifies the new set of access rights. The **-C** command directs EDACL to change the access rights for the specified SID.

For example, suppose the file *REPORT* has the following ACL entry granting full rights:

```
%%.MAN.%          pgndrwx
```

The following command changes the access rights for *%%.MAN* to *READ (R)* access:

```
$ EDACL REPORT -C %%.MAN R
```

As a result, the new ACL entry now looks like this:

```
%.%.MAN.%          - - - - r -
```

If you try to change the access rights for an entry that doesn't exist, you will receive an error message.

Adding Entry Rights

To add access rights to an existing ACL entry, use the **-AR** command in the following format:

```
EDACL pathname ... -AR ppon rights
```

where *ppon* specifies the SID for the entry you want to change, and *rights* specifies the new set of access rights. The **-AR** command directs EDACL to add rights to the existing list of access rights for the specified SID.

For example, suppose the file *REPORT* has the following ACL entry:

```
%.%.MAN.%          - - - - r -
```

The following command adds the rights *WRITE* (*W*) and *EXECUTE* (*X*) to the current access rights for *%.%.MAN*.

```
$ EDACL /OWNER/REPORT -AR %.%.MAN WX
```

As a result, the ACL entry now looks like this:

```
%.%.MAN.%          - - - - wrx
```

If you try to add rights to an entry that doesn't exist, you will receive an error message.

Deleting Entry Rights

To delete the set of rights from a particular ACL entry, use the **-DR** command in the following format:

```
EDACL pathname ... -DR ppon rights
```

where *ppon* specifies the SID for the entry you want to change, and *rights* specifies the access rights you want to delete. The **-DR** command directs EDACL to delete the access rights for the specified SID.

For example, suppose the file *REPORT* has the following ACL entry:

```
%.%.MAN.% - - - - wrx
```

The following command deletes *WRITE* (*W*) access from the current access rights for *%.%.MAN*:

```
$ EDACL /OWNER/REPORT -DR %.%.MAN W
```

As a result, the ACL entry now looks like this:

```
%.%.MAN.% - - - - rx
```

If you try to delete rights from an entry that doesn't exist, you will receive an error message.

Deleting ACL Entries

To delete an entry (SID and rights) from an ACL, use the **-D** command in the following format:

```
EDACL pathname ... -D ppon
```

where *ppon* specifies the SID for the entry you want to delete. For example:

```
$ EDACL /OWNER/REPORT -D %.%.MAN.%
```

This command deletes the entry *%.%.MAN.%* from the ACL for the file *REPORT*.

Copying ACLs

To copy an ACL from one object to another, use the **ACL** (**ACCESS_CONTROL_LIST**) command in the following format:

ACL target source

where *target* specifies the pathname of the object to which you want the ACL copied. The *source* argument specifies the pathname of the object whose ACL you want to copy.

The following command copies the ACLs from the directory */OWNER* to the directory */USER_1*:

```
$ ACL /USER_1 /OWNER
```

Initial ACLs

Whenever you create a new file or directory, the system assigns it a default ACL by copying a special ACL, called an **initial ACL**, from the parent directory. Each directory, in addition to its own ACL, has two initial ACLs: an **initial file ACL** for new files, and an **initial directory ACL** for new directories.

For example, if you create a file named *REPORT* in the directory *OWNER*, the system assigns *REPORT* the initial file ACL of the directory *OWNER*. If you create a subdirectory in *OWNER*, the system assigns the new subdirectory *OWNER*'s initial directory ACL. New subdirectories also receive a set of initial ACLs that match the parent directory's initial ACLs. In this example, the new subdirectory also receives *OWNER*'s initial ACLs.

Figure 8-4 shows how the system assigns initial ACLs to files and directories.

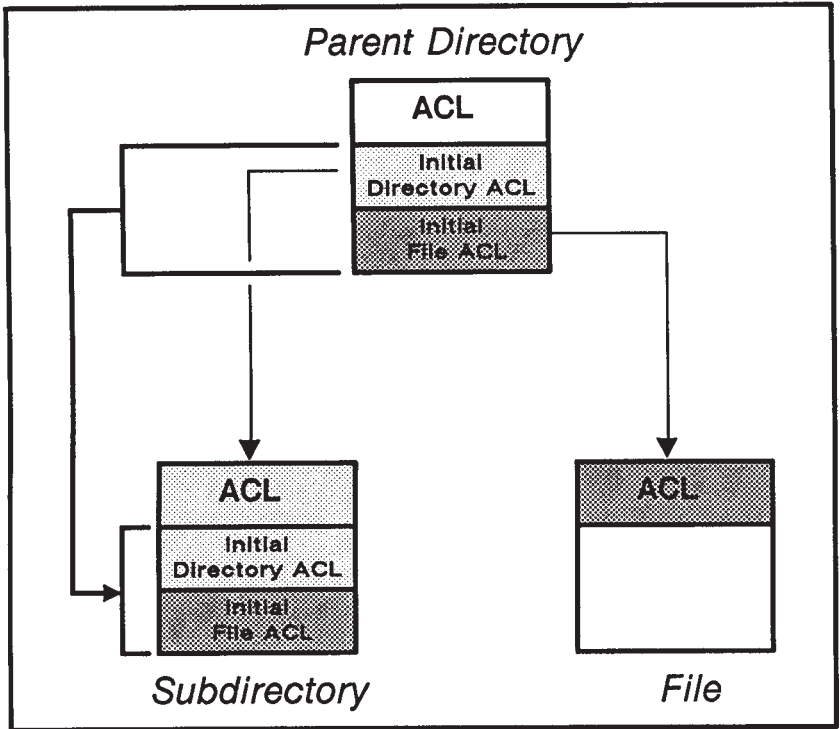

Figure 8-4. Initial ACLs for Files and Directories

Table 8-5 summarizes the commands used to edit and copy initial ACLs.

Table 8-5. Summary of Commands for Editing and Copying Initial ACLs

Task	Command
Edit Initial directory ACL	EDACL pathname -ID command
Edit Initial file ACL	EDACL pathname -IF command
Copy both Initial ACLs	ACL target source -l
Copy Initial directory ACL	ACL target source -ID
Copy Initial file ACL	ACL target source -IF

Editing Initial ACLs

You can edit a directory's initial ACLs with the EDACL command. To edit the **initial directory ACL**, use EDACL with the **-ID** option in the following format:

EDACL pathname -ID -command

where *-ID* directs EDACL to edit initial directory ACLs, and *-command* specifies one of the ACL editing commands described in the “Editing ACLs” section discussed earlier. For example:

```
$ EDACL /OWNER -ID -L
```

The command in this example displays the initial directory ACL for the directory */OWNER*.

To add an entry to the initial directory ACL for */OWNER*, use the **-A** command as follows:

```
$ EDACL /OWNER -ID -A %%.ENG ALDR
```

The following example uses the **-DR** command to take away or delete *DELETE (D)* rights from the entry we added in the previous example:

```
$ EDACL /OWNER -ID -DR %%.ENG D
```

To edit the **initial file ACL**, use the EDACL command with the **-IF** option in the following format:

```
EDACL pathname -IF -command
```

where *-IF* directs EDACL to edit initial file ACLs, and *-command* specifies one of the ACL editing commands described in the “Editing ACLs” section discussed earlier. For example:

```
$ EDACL REPORT -IF -L
```

The command in this example displays the initial file ACL for the file *REPORT*.

Copying Initial ACLs

You can copy a directory’s initial ACLs using the ACL command in the following format:

```
ACL target source option
```

where *option* specifies one of the options listed in Table 8-6. The *target* argument specifies the pathname of the object to which you want the initial ACL copied. The *source* argument specifies the pathname of the object whose initial ACL you want to copy.

Table 8-6. Options for Copying Initial ACLs

Option	Description
-I	Copies both the initial file and initial directory ACLs from the source to the target.
-ID	Copies the initial directory ACL from the source to the target.
-IF	Copies the initial file ACL from the source to the target.

The command in the following example uses the *-I* option to copy the initial file and directory ACLs from the directory */OWNER* to the directory */USER_1*.

```
$ ACL /USER_1 /OWNER -I
```

To copy only the initial file ACL, use the *-IF* option as shown in the following example:

```
$ ACL /USER_1 /OWNER -IF
```

For a complete description of how to use the ACL command to copy initial ACLs, see the *DOMAIN System Command Reference*.

Protected Subsystems

Another method of controlling access to files is through a protection mechanism called a **protected subsystem**. Protected subsystems allow you to designate a collection of data (a protected group of files) for use solely by specific programs.

A protected subsystem is composed of one or more programs and a set of data files. The programs are called the **managers** of the protected subsystem; the data files, called **data objects**, are owned

by the subsystem. Thus, files in a protected subsystem have either manager or data object status.

Protected subsystems permit broad groups of users to access data objects through the programs, or managers, of the subsystem. You typically create a protected subsystem when you want only specific programs to act on data files, regardless of the SIDs of the processes in which the programs run.

For example, you might have a group of data files produced and used by a specific program. If you want to prevent these files from being used for any other purpose, you can assign protected subsystem status to both the program and the data files. As a result, only those users authorized to run the subsystem manager program can use the files protected by the subsystem.

This section explains how to create a protected subsystem and how to assign subsystem status to files.

How Do Protected Subsystems Work?

In order to understand how to assign subsystem status to files, you must first understand how the system handles protected subsystems. Figure 8-5 presents a flowchart that shows how the system controls access to protected subsystem files.

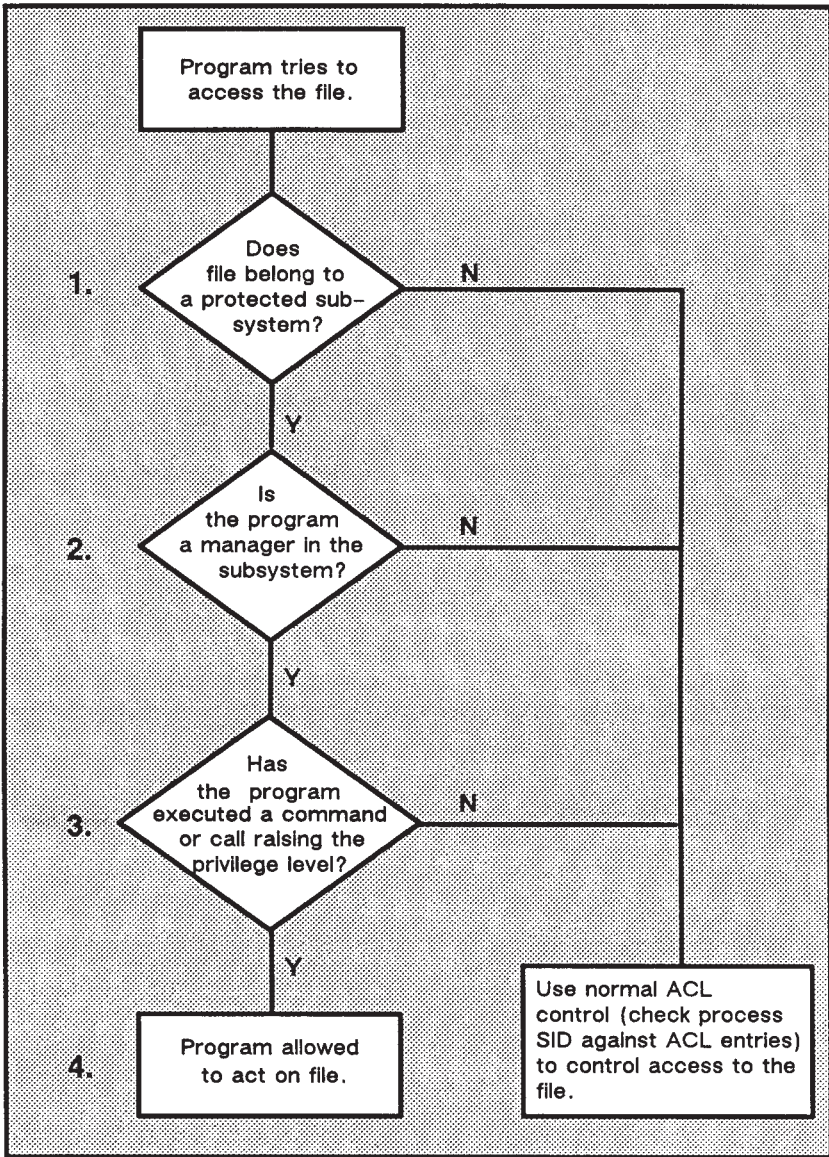

Figure 8-5. Controlling Access to Protected Subsystem Files

The following descriptions explain the sequence of events shown in Figure 8-5:

1. When a program in a protected subsystem requests access to a file, the system first checks whether the file belongs to a protected subsystem. If the file does *not* belong to a protected subsystem, the system uses the file's ACL information to control access.
2. If the file *does* belong to a protected subsystem, the system determines whether the requesting program owns the file (whether the program is a manager in that subsystem). If the program is *not* a manager in that subsystem, the system treats it like any other program and uses ACL information to control access.
3. If the program *is* a manager in that subsystem, the system verifies that the program has executed a command or system call that raises the manager program's privilege level. If a manager program hasn't raised its privilege level, the system treats it like a non-manager program and uses ACL information to control access.

The system allows you to raise a program's privilege level by using either the Shell command **SUBS (SUBSYSTEM)** or a set of programming calls. For more information, see the **SUBS** Shell command in the *DOMAIN System Command Reference* or the **ACLM** call descriptions in the *DOMAIN System Call Reference*.

4. If the manager program has raised its privilege level, the system allows it to operate on the file.

To use a protected subsystem, you must first create it, and then enter it to add files. The following sections describe how to create and enter a protected subsystem.

Creating a Protected Subsystem

To create a protected subsystem, use the **CRSUBS** (**CREATE_SUBSYSTEM**) command in the following format:

```
CRSUBS subsystem_name
```

where *subsystem_name* specifies the name you want to assign to the subsystem. For example, the following command creates a protected subsystem named *PROTECTOR*:

```
$ CRSUBS PROTECTOR
```

When you create a protected subsystem, the system assigns it the subsystem name that you specify. The system also assigns the subsystem name to a subsystem Shell in the node's */SYS/SUBSYS* directory. The subsystem Shell is actually a copy of the Shell program. This Shell program is the first manager program in your newly-created subsystem.

The operating system uses the managers in the */SYS/SUBSYS* directory when it checks for the names of protected subsystems. Internal to the ACL for each of these managers, and to the ACL for any file, is a field for protected subsystem status. Only the operating system can see this field. If the file belongs to a protected subsystem, the field contains an internal identifier for that subsystem. All files in a particular subsystem, including the files in */SYS/SUBSYS*, have the same internal identifier.

When you display an object's ACL (see the "Displaying ACLs" section discussed earlier), the system looks at the ACLs subsystem field. If the field contains a subsystem identifier, the system looks in */SYS/SUBSYS* for a file with the same internal identifier. The system then displays the name of that file as the name of the subsystem.

To use **CRSUBS** to create a protected subsystem, you must have **ADD** rights to the */SYS/SUBSYS* directory. The initial file ACL for this directory must also grant **READ** and **EXECUTE** rights to any file created in */SYS/SUBSYS*. You should normally limit these rights to the creator of the subsystem or to the system administrator.

Assigning Protected Subsystem Status

Before you can assign subsystem status to files, you must first enter the subsystem using the **ENSUBS** (**ENTER_SUBSYSTEM**) command in the following format:

```
ENSUBS subsystem_name
```

where *subsystem_name* specifies the name of the subsystem you want to enter. (To use **ENSUBS** to enter a subsystem, you must have *READ* and *EXECUTE* access to the subsystem file in */SYS/SUBSYS*.) For example, the following command lets you enter the subsystem named *PROTECTOR*:

```
$ ENSUBS PROTECTOR
```

When the dollar sign prompt appears after you specify **ENSUBS**, you are “inside” the subsystem. Once inside, you can assign manager or data object status to files using the **SUBS** (**SUBSYSTEM**) command in the following format:

```
SUBS pathname subsystem_name option
```

where *pathname* specifies the name of the file, and *subsystem_name* specifies the name of the current subsystem. The *option* specifies either **-MGR** for manager status or **-DATA** for data object status. For example:

```
$ SUBS MY_PROG PROTECTOR -MGR  
$ SUBS DATA_1 PROTECTOR -DATA  
$ SUBS DATA_2 PROTECTOR -DATA
```

The commands in this example assign subsystem status to files of the subsystem *PROTECTOR*. The first command assigns manager status to the program file *MY_PROG*. (You can assign manager status to either a binary program or a script.) The remaining commands assign data object status to the files *DATA_1* and *DATA_2*.

When you’re finished assigning status to files, you can leave the protected subsystem by typing **CTRL/Z**. You’ve exited the protected subsystem when the EOF marker appears and the dollar sign prompt returns.

```

# Create the subsystem.
$ crsubs protector
# Change ACL entries for the subsystem.
$ edacl /sys/subsys/protector -af fran.%lab.% -owner
$ edacl /sys/subsys/protector -cf %.sys_admin -owner
$ edacl /sys/subsys/protector -cf %.%.%.% -none
# Check to make sure entries are right.
$ acl /sys/subsys/protector
ACL for /sys/subsys/protector
Subsystem protector manager
  fran.%lab.%          pgndwrx
  %.sys_admin.%.%     pgndwrx
  %.%.%.%             - - - - -
# Enter the subsystem.
$ ensubs protector
# Assign subsystem status to two files.
# The files must already exist.
$ subs /owner/my_prog protector -mgr
$ subs /owner/data_1 protector -data
# List the subsystem status to check for mistakes.
$ subs /owner/my_prog
"/owner/my_prog" is a PROTECTOR subsystem manager
"/owner/my_prog" is a file subsystem data object
$ subs /owner/data_1
"/owner/data_1" is a nil subsystem manager
"/owner/data_1" is a PROTECTOR subsystem data object.
# Type CTRL/Z to exit the subsystem.
$ ***EOF***
$

```

Figure 8-6. Sample of a Protected Subsystem Transcript

Figure 8-6 contains a transcript that shows how a user created a protected subsystem, entered it, created a subsystem manager and data object, and exited the subsystem.

CHAPTER 9

Writing Shell Scripts

Most of the Shell command examples that you've seen so far show you how to use commands interactively by specifying them in the Shell input pad. You can also use Shell commands in Shell scripts. **Shell scripts** are essentially programs made up of Shell commands and other valid Shell characters, operators, and expressions. Think of scripts as programs written in the "Shell language."

This chapter describes how to write Shell scripts using Shell commands, operators, and expressions. Although you can use many of the commands and conventions presented in this chapter when you use the Shell interactively, they have their most practical applications in scripts.

Creating Your Own Commands

In its simplest form, a script is a file containing Shell commands that you create to perform some customized operation. For example, a Shell script can contain a sequence of commands that you specify frequently, such as `WD` to set the working directory, and `LD` to list the directory's contents. Or, it could contain a single command with a long list of options. By including commands such as these in a script, you can execute them at any time by specifying a single command name.

For example, when you specify the `LD` command to list the contents of a directory, by default it displays only the name of each object. Suppose, however, that you want to display each object's access rights, creation date, and object type. Normally, each time you specify the `LD` command you have to specify the same list of options. Instead, you can create a Shell script named *LIST* that contains the following command line:

```
LD -R -DTC -ST
```

Whenever you specify the command name *LIST*, the Shell lists the access rights, creation date, and object type of each object in the current working directory.

Of course, you can write much more complicated scripts that perform more sophisticated tasks. This section describes some of the basic components for writing scripts.

Creating Scripts

To create a script, simply create a file and insert Shell command lines. Command lines in scripts use the same command line format described in Chapter 6.

Like commands that you enter in the Shell input pad, you can use parsing operators like the semicolon (`;`) to separate commands on a command line, and the escape character (`@`) to continue a command on more than one line. Other operators, like the pound sign character (`#`), have functions more suited for use in scripts. The `#` character allows you to include comments in your scripts, since it directs the Shell to ignore anything that follows it on the command

line. Table 9-1 lists the Shell parsing operators you'll use when writing scripts.

Table 9-1. Shell Parsing Operators

Character	Function
#	Direct the Shell to ignore anything that follows it on the command line.
;	Separate commands on a line.
&	Run a command or program in the background without pads and windows (see Chapter 6).
^n	Substitute nth parameter (n is a number).
^*	Substitute all parameters (not including the command itself).
!n	Substitute parameter for n (n is a number) and rescan it.
!*	Substitute and rescan all parameters (not including the command name itself).
'string'	Quoted string, no parameters inserted.
"string"	Quoted string, parameter may be inserted.
@	Escape character
	Space (separates arguments).

An important consideration when creating scripts is where to create them. Remember, when you specify a command name, the Shell searches for the corresponding file according to a set of command search rules. By default, the second directory the Shell searches is your personal command directory *~COM*. Therefore, you should

normally create your own personal scripts there. In fact, all of the examples in this chapter assume that the scripts reside in your *~COM* directory. For more information on command search rules, refer to Chapter 6.

Passing Arguments to Scripts

Let's take a look at a slightly more sophisticated script. This script is in a file called *COMPILE* and contains the following lines:

```
# COMPILE
#
# This file compiles and binds PROG
#
PAS PROG -L -MAP -OPT
BIND PROG.BIN -MAP >PROG.MAP
ARGS "PROG compiled and bound."
```

When you specify *COMPILE* in the Shell input pad, the Shell executes the script. The script compiles and binds the program in file *PROG* and produces various output files (listings and maps), all in the current working directory. When finished, it uses the **ARGS (ARGUMENTS)** command to display the message, "PROG compiled and bound."

The **ARGS** command uses standard output to write its arguments (one per line) to the Shell transcript pad. You can use the **ARGS** command in scripts to display the results of expressions (see the "Using Expressions" section) or to display messages and diagnostics (as in the previous example). In fact, many of the examples in this chapter use the **ARGS** command to show how the Shell evaluates various strings and expressions. You can also use the **ARGS** command with the *-ERR[OUT]* option to write arguments to error output.

The Shell script *COMPILE* isn't very useful, since it only operates on a single file named *PROG* and performs fixed compilation and binding operations. A script is more versatile if you can pass arguments to it when you specify the command to invoke it. Consider the following script named *COMPILE2*:

```
#  
# COMPILE2  
#  
# This file compiles and binds a program whose name you  
# pass to it as (^1).  
#  
PAS A1 -L -MAP -OPT  
BIND A1.BIN -MAP >A1.MAP  
ARGS "A1 compiled and bound."
```

Specifying the following command in the Shell input pad causes the Shell to find and execute the script *COMPILE2*:

```
$ COMPILE2 MY_PROG
```

The Shell substitutes *MY_PROG*, which is the first argument on the command line, for every occurrence of the (^1) in the script. As a result, the script compiles *MY_PROG*, binds *MY_PROG.BIN*, writes a map to *MY_PROG.MAP*, and when complete, writes the message:

```
MY_PROG compiled and bound.
```

Arguments that you specify on the command line correspond to symbols in the script, called **substitution parameters**. Each substitution parameter is composed of a caret character (^) and a number. The caret character (^) instructs the Shell to substitute an argument for the parameter; the number refers to the position the argument occupies on the command line that invoked the script.

In the previous example, ^1 refers to *MY_PROG*, which is the first argument after the command name *COMPILE*. You can use any number of substitution parameters in Shell scripts (beginning with ^0 which refers to the command name itself).

Our *COMPILE2* script is still very specific, since the compile and bind operations are still fixed. To make those operations variable, simply pass in more parameters. Consider the following script named *COMPILE3*:

```

#
# COMPILE3
#
# ***** (THIS EXAMPLE IS WRONG) *****
#
# This file compiles and binds a program whose name you
# pass to it as ^1, and whose options you pass to it as ^2.
#
PAS ^1 ^2
BIND ^1.BIN -MAP >^1.MAP
ARGS “^1 compiled and bound.”

```

How do we pass the multiple parameters if we want *COMPILE3* to behave like *COMPILE2*? Let’s take a look at what happens if we specify the following command:

```

$ COMPILE3 MY_PROG -L -MAP -OPT
           | | | |
           1  2  3  4

```

As shown in this example, the Shell tries to substitute *-L* for parameter 2, *-MAP* for 3, and *-OPT* for 4. This command won’t work, however, because *COMPILE3* doesn’t contain substitution parameters ^3 and ^4. As a result, the Shell ignores the *-MAP* and *-OPT* options.

Normally, we can group the arguments and pass them as a single argument by enclosing them in single quotation marks as follows:

```

$ COMPILE3 MY_PROG '-L -MAP -OPT'
           | |
           1  2

```

The single quotation marks tell the command Shell to treat the characters inside them as a single string, even if there are intervening spaces. When you specify the command, the Shell substitutes the

string `'-L -MAP -OPT'` for substitution parameter 2 in *COMPILE3*. However, this still won't work, because the Shell tries to interpret the entire string as a single argument, instead of the three separate options the string represents.

Let's look at a fourth and final *COMPILE* script to see how to solve our problem.

```
#
# COMPILE4
#
# ***** (THIS EXAMPLE IS CORRECT) *****
#
# This file compiles and binds a program whose name you
# pass to it as ^1, and whose options you pass to it as !2
#
PAS ^1 !2
BIND ^1.BIN -MAP >^1.MAP
ARGS “^1 compiled and bound.”
```

Now, typing the following command will work:

```
$ COMPILE4 MY_PROG '-L -MAP -OPT'
                |                |
                1                2
```

Like the caret (^), the exclamation point (!) parsing operator causes the Shell to substitute the string in quotation marks for the second parameter. However, the exclamation point directs the Shell to rescan the command line before executing it. When the Shell scans the line a second time it breaks apart the three options in the string. As a result, the Shell interprets the options correctly.

Using Quoted Strings

The proper use of quotation marks can make a big difference in the way the Shell interprets quoted strings. In order to use quoted strings correctly in scripts, you must understand the subtle differences in the Shell's interpretation of single and double quotation marks.

When you want the Shell to interpret a string literally, you can use either single or double quotation marks as follows:

```
ARGS 'compiled and bound'
```

or

```
ARGS "compiled and bound"
```

Both commands use standard output to write the message, "compiled and bound" to the Shell's transcript pad. But suppose you wanted to substitute arguments inside the quoted string.

To substitute arguments inside a quoted string, you must use double quotation marks. For example, let's use a line from the script, *COMPILE4* that we created in the "Passing Arguments to Scripts" section.

```
ARGS "^1 compiled and bound"
```

When you use double quotes, the Shell performs substitutions in the quoted string. In this example, if the argument passed to the script is *MY_PROG*, the Shell outputs the string:

```
MY_PROG compiled and bound.
```

On the other hand, if you enclose the string in single quotation marks:

```
ARGS '^1 compiled and bound.'
```

the Shell will not perform the substitution. Instead, it displays the message:

```
^1 compiled and bound.
```

Using In-Line Data

As we saw in Chapter 6, certain Shell commands use standard input to read data from the Shell input pad. When you use these commands in scripts, you can redirect standard input to read data from within the script itself.

For example, the **ED (EDIT)** command normally uses standard input to read special editing commands that you enter in the Shell input pad. Using the I/O redirection character (<<), you can redirect standard input to read commands from inside the script instead. Figure 9-1 shows a script in which the ED command reads in-line data.

```
#
# This is a sample script that uses in-line data
#
ED MY_FILE << /
editing commands
.
.
.
/
```

Figure 9-1. Including In-Line Data in a Script

In Figure 9-1, the list of editing commands between the two slash characters (/) is called a **here document**. The I/O redirection character (<<) redirects standard input to read the data (in this case commands) contained in the here document.

The script in Figure 9-1 uses a slash character (/) as a delimiter to indicate both the beginning and end of the here document. You can use any character as a delimiter, as long as the beginning and ending characters are the same. Also, in order for the Shell to recognize the end of the here document, you must specify the ending delimiter as the first and only character on the line.

Executing DM Commands from Shell Scripts

You can invoke DM commands from the command Shell or from within a Shell script using the Shell command **XDMC** (**EXECUTE_DM_COMMAND**) in the following format:

```
XDMC dm_command
```

where *dm_command* specifies the name of the DM command you want to execute. For example:

```
XDMC CV NEWS
```

This command executes the DM command CV (**CREATE_VIEW**) to open a read-only pad and window for the file *NEWS*.

Debugging Shell Scripts

Normally, when a script runs, it doesn't display commands as it executes them. As a result, when a script doesn't work, it is difficult to locate which command or commands cause the errors.

To debug a Shell script, invoke the script using the **SH** (**SHELL**) command in the following format:

```
SH option script
```

where *script* specifies the name of the script, and *option* specifies one of the options in Table 9-2. Each option activates a specific function.

The following command executes the script *COMPILE* and writes each command line to standard output immediately before execution:

```
$ SH -X COMPILE
```

Table 9-2. Script Verification Options

Option	Function
-x	Writes each command line in the script to standard output immediately before execution. Provides the complete pathname for each command and evaluates all expressions.
-v	Writes each command line in the script to standard output. Each variable is expanded, but expressions are not evaluated, and command pathnames are not expanded.
-n	Interprets commands without actually executing them.

If you want to turn either of these features on or off without using the SH command options, you may specify the Shell commands **VON**, **VOFF**, **XON**, or **XOFF** and then run your script directly using the current Shell. For example, the following are equivalent:

```
$ SH -X COMPILE
```

or

```
$ XON
```

```
$ COMPILE
```

```
$ XOFF
```

You can also include these commands within the script itself to enable or disable verification. For example, to debug part of a script, you can place XON and XOFF commands around the segment of the script you want to debug. Or, to debug an entire script, include the XON command as the first line in the script. When the script completes, control of verification returns to the Shell.

Using Expressions

Like programs written in a high-level programming language such as FORTRAN or Pascal, scripts allow you to use expressions to perform mathematical, string, and Boolean operations. Table 9-3 provides a summary of the operators you can use in expressions.

To evaluate an expression, you must enclose the expression within **expression delimiters** (a set of double parentheses) as follows:

```
ARGS (( 4 + 2 ))
```

The only exception to this rule is the case where you use the assignment operator (:=) to assign an expression to a variable:

```
TOTAL := 4 + 2
```

In this example, the Shell evaluates the expression and assigns the resulting value to the variable *TOTAL*. While the assignment operator doesn't require you to use expression delimiters, you can use them if you prefer; no error will occur if you do use them. The "Defining Variables" section describes how to use the assignment operator to assign values to variables.

Table 9-3. Summary of Expression Operators

Type	Char.	Function	Legal Operands	P^①
Grouping Operators	()	Group operations	Any value	8
Math Operators	+	Positive value	Integer	7
	-	Negative value	Integer	7
	**	Op1 to the Op2	Integers	6
	Mod	Mod Op1 by Op2	Integers	5
	*	Multiply	Integers	4
	/	Divide	Integers	4
	+	Add	Integers	3
	-	Subtract	Integers	3
String Operators	+	Concatenate	Strings	3
	-	Subtract last occurrence of Op2	Strings	3
Math or String Comparison Operators	=	Compare for equality	Integer or string	2
	<	Less than	Integer or string	2
	>	Greater than	Integer or string	2
	<=	Less than or equal to	Integer or string	2
	>=	Greater than or equal to	Integer or string	2
	<>	Not equal	Integer or string	2
Logical Operators	or	Logical or	Boolean	1
	and	Logical and	Boolean	1
	not	Logical negate	Boolean	9

1. Precedence: 1 is the lowest; 9 is the highest

Operands in Expressions

You can use any of the following as operands in expressions:

- Single integer, string, or Boolean values
- Operations that result in integer, string, or Boolean values
- Variables assigned integer, string, or Boolean values (the “Shell Variables” section describes variables).

Certain types of operations in expressions take precedence over others. For example, the Shell will perform a mathematical operation in an expression before a comparison operation. As shown in Table 9-3, the Shell performs operations according to a specific order of precedence where 1 is the lowest (last performed) and 9 is the highest (first performed).

The last operation performed in an expression (the operation with the lowest precedence) determines the type of value, either integer, string, or Boolean, returned by the expression.

When you create expressions, refer to Table 9-3 to check the precedence of the operators you use. Understanding the order in which the Shell performs operations will reduce the possibility of an expression resulting in an unexpected answer. Many of the examples that we’ll see in this chapter demonstrate operator precedence.

Mathematical Operators

Use mathematical operators in expressions to perform calculations on integers. The result of a mathematical operation is always an integer. For example:

```
ARGS (( 5 + 4 * 3 - 2 ))
```

returns the value *15*. If you’re wondering why the answer isn’t 9 (9 times 1), the reason is that the Shell performs multiplication operations in this expression before it performs addition and subtraction operations. In our example, the Shell multiplied 4 by 3 before it added 5 and subtracted 2.

To perform the addition and subtraction first, you could use the **grouping operators** (parentheses) to group the addition and subtraction operations within the expression as follows:

```
ARGS (( 5 + 4 ) * ( 3 - 2 ))
```

The Shell always performs operations inside parentheses first, from left to right. In this example, the Shell first adds 5 and 4 and subtracts 2 from 3, and then multiplies the resulting values. Table 9-3 lists the order of precedence for all operators where 1 is the lowest and 9 is the highest precedence.

Since all mathematical operators perform integer arithmetic, expressions always result in whole numbers; the Shell truncates fractional values.

String Operators

Use string operators to either concatenate or reduce strings. For example:

```
ARGS (( "FILE" + ".PAS" ))
```

uses the + operator to concatenate two strings and form the string *FILE.PAS*.

Using the - operator to reduce a string is a little trickier. Let's look at a simple example first:

```
ARGS « "FILE.PAS" - ".PAS" »
```

This operation subtracts the second operand from the first operand to return the string *FILE*. The behavior of the - operator gets more complicated when the first operand contains more than one occurrence of the second operand. In this case, the Shell string you are subtracting matches the last occurrence in the first operand. For example:

```
ARGS (( "PROG.PAS AND FILE.PAS" - ".PAS" ))
```



This expression subtracts the last occurrence of the second operand (*.PAS*) from the first operand. The result of this example is *PROG.PAS AND FILE*. To subtract both occurrences of the string *.PAS* in the first operand, use the following expression:

```
ARGS (( "PROG.PAS AND FILE.PAS" - ".PAS" - .PAS ))
```



This expression performs two operations, each subtracting the last occurrence of the string *.PAS* in the first operand. The result is the string *PROG AND FILE*.

When you use string operators, the Shell treats all operands as strings. If an operand in a string operation is an integer, the Shell converts the integer to a string. For example:

```
ARGS (( 50 + "shares at $" + 30 + "a share is $" @  
+ (50 * 30) ))
```

returns the string

```
50 shares at $30 a share is $1500
```

Notice that the Shell performs the mathematical operation inside the grouping operators first. The result of this operation ($50 * 30$) is the integer 1500. Since this integer is part of a string concatenation operation, the Shell converts it to a string. Even if you omitted the grouping operators, the Shell would still multiply the two integers first, since multiplication operations have a higher precedence than string concatenation operations (see Table 9-3).

Comparison Operators

Use comparison operators to compare either integer or string values. The result of a comparison operation is always a Boolean value (true or false). The following expression compares two integers:

```
ARGS (( 5 > 2 ))
```

This expression results in the Boolean value *TRUE*, because the integer 5 is greater than the integer 2.

When you compare strings, the Shell compares them according to the sequential position they hold in the ASCII character set. For example:

ARGS ((a < b))

results in the value *TRUE* because *a* holds a lower position than *b* in the character set. Also, the Shell is case-sensitive when comparing strings. For example, the following expression results in the value *FALSE*:

ARGS ((A = a))

Logical Operators

Use logical operators to perform logical operations with Boolean values. The result of a logical operation is always a Boolean value. For example:

ARGS ((5 > 2 OR 5 > 6))

results in the value *TRUE*. In this example, the first operand (the result of the integer comparison) is true, while the second operand is false (5 is not greater than 6). With the OR operator, if either one of the operands results in the value *TRUE*, then the result of the operation is *TRUE*.

When you use the AND operator, both operands must be true for the operation to result in a *TRUE* value. For example:

ARGS ((5 > 2 AND 5 > 6))

This expression results in the value *FALSE* because both operands are not *TRUE*; the second operand is *FALSE*.

Shell Variables

You use variables in Shell scripts as symbolic names for specific integer, string, or Boolean values. Once you assign a value to a variable name, you can refer to that value in the script by its variable name rather than its actual value.

- The Shell allows you to use variables in any of the following:
- Command lines as commands, arguments, or options
- Here documents
- Strings enclosed in double quotation marks
- Expressions

Defining Variables

To define a variable, use the assignment character (`:=`) in the following format:

```
variable name := value
```

where *variable name* specifies the name of the variable, and *value* specifies the value you want to assign to the variable. Variable names can contain alphanumeric characters, as well as the underscore (`_`) and dollar sign (`$`), and up to 1024 characters. You **MUST**, however, begin all variable names with a letter. (Variables are not case-sensitive.) The following statement assigns the integer value 30 to the variable name `WORK_DAYS`:

```
WORK_DAYS := 30
```

Unlike many programming languages that require you to declare variable types, the Shell automatically assigns the variable a type based on the assigned value. In the previous example, since the value 30 is an integer, the Shell assigns the variable `WORK_DAYS` the type *integer*. Table 9-4 lists the rules the Shell uses to assign variable types.

When you define a variable at the current Shell level, you define it for all levels below the current Shell level. For example, suppose you

define the variable *D* := 25 in the Shell input pad, and then execute a Shell script. Since scripts run at a lower Shell level, the value assigned to variable *D* remains 25, unless the script redefines the variable by changing its value. If the script does change the value for variable *D*, the value returns to 25 when the script completes execution.

Table 9-4. Rules for Assigning Variable Types

Type	Assignment Rule
Integer	<p>When the assigned value is an integer, constant, an integer expression, or another integer variable. For example:</p> <pre>INT := 7</pre> <p>or</p> <pre>INT := 5 + (4-2)</pre>
String	<p>When the assigned value is a quoted string, a string constant, a string expression, or another string variable. For example:</p> <pre>STR := "APRIL" + ^VAR2</pre>
Boolean	<p>When the assigned value is a Boolean constant (<i>TRUE</i> or <i>FALSE</i>), a Boolean expression, or another Boolean variable. For example:</p> <pre>BOOL := ^VAR1 = VAR2</pre>

Using Shell Variables

To use a Shell variable, precede the variable name with the substitution character (`^`). When the Shell encounters the substitution character in a command line, it substitutes the value of the variable

for the variable name. Variable names are *not* case-sensitive. Let's look at an example.

Suppose we assign the variable *CITIES* a string value:

```
CITIES := "Boston and NY"
```

To use the variable *CITIES*, simply precede it with the substitution character as follows:

```
ARGS (( "Cities with early flights are" + ^CITIES ))
```

The **ARGS** command uses standard output to display the result of the expression to the transcript pad. In this example, the Shell substitutes the string value "Boston and NY" for the variable name *CITIES*. The expression concatenates the first string and the second string to form the following string:

```
Cities with early flights are Boston and NY
```

The Shell automatically substitutes values for (evaluates) Shell variables when you use them as operands in expressions (as shown in the previous example). However, you may want to evaluate a variable that isn't part of an expression. Consider the following example:

```
ARGS "Cities with early flights are ^CITIES"
```

By default, the Shell won't evaluate the variable *CITIES* since the variable is not used in an expression. In order for the Shell to evaluate variables outside of expressions, you must turn on evaluation using the **EON** command.

You can either specify the **EON** command before you run a script to turn on evaluation for the current Shell, or include the **EON** command in the script itself. The **EON** command, when used in a script, turns on evaluation for the script only, not for the current Shell. To turn evaluation off, use the **EOFF** command.

With variable evaluation turned on, the command in the previous example evaluates the variable *CITIES* and displays the following string:

```
Cities with early flights are Boston and NY
```

You can also turn evaluation on when you create a Shell by specifying the *-E* option with the **SH (SHELL)** command. By default, when you create a Shell, evaluation is off.

Variable Commands

The Shell provides three commands that let you verify or delete variables. Table 9-5 lists these commands.

Table 9-5. Variable Commands

Command	Description
EXISTVAR	Verifies whether the variable(s) you specify as arguments exist. If all of the variables specified exist, the command returns the value <i>TRUE</i> . If anyone of the variables does not exist, the command returns the value <i>FALSE</i> .
LVAR	Lists the type, name, and assigned value of the variable(s) you specify as arguments. If you don't specify any variables, LVAR lists information about currently assigned variables.
DLVAR	Deletes all variables that you specify as arguments.
EXPORT	Changes all specified variable names into environment variables. If the specified variable does not exist, EXPORT creates it.

The **EXISTVAR** and **LVAR** commands verify variables defined at the current level and every level above. For example, when you specify the **LVAR** command from within a script, the command lists variables defined in the script, as well as variables defined at the

Shell level (one level above). When you specify **LVAR** at the Shell level, the command lists only variables defined at the Shell level.

The **DLVAR** command deletes only the variables defined at the current level. For example, suppose you defined the variable `D:= 25` at the Shell level. If you executed a script that used the **DLVAR** command to delete the variable `D` (assuming that you didn't redefine `D` in the script), you'd receive an error. In this example, if the script redefined `D` by assigning it a new value, the command would delete the new value, and `D` would return to the value defined at the Shell level.

Use the **EXPORT** command to **create environment variables** or change variables into environment variables. Environment variables store global state information about the system. We supply a set of default environment variables that you can list using the **LVAR** command.

Defining Variables Interactively

So far, we've looked at variables that you either define at the Shell level or from within scripts. When you define variables in a script, you assign them initial values. These initial values are used every time you execute the script, unless you edit the script to change the values prior to each execution.

Instead of including values for variables directly in scripts, you can direct the script to read values supplied by the user of the script. To read user input into variables, use the **READ** command in the following format:

```
READ [option] variable_list
```

where *variable_list* specifies one or more variables that receive the input values. Figure 9-2 shows a sample script that demonstrates how to use the **READ** command to read user input.

```

# STOCKS
#
# This script calculates the value of stock holdings.
# It reads in both the number of shares held by the
# user, and the current market price per share.
#
# Read in number of shares
#
READ -PROMPT "Number of shares:" SHARES
#
# Read in current market price
#
READ -PROMPT "Current market value:" PRICE
#
# Calculate value of holdings and display value.
#
ARGS (( " ^SHARES shares at $ ^PRICE per share $ " + @
( ^SHARES * ^PRICE ) ))

```

Figure 9-2. A Sample Script Using the READ Command

By default, the Shell uses standard input to read values that the user of the script types in the Shell input pad. Our sample script in Figure 9-2 uses two `READ` commands: one reads in the number of shares and assigns the value to the variable `SHARES`, the other reads in the current price of each share and assigns the value to the variable `PRICE`. Notice that each `READ` command uses the `-PROMPT` option to prompt the user for the proper input. To see just how this script works, create your own copy and execute it.

The sample script in Figure 9-2 expects the user to supply integer values. But what if the user entered a string or Boolean value? The script would use the value, and as a result, the final calculation (`^SHARES * ^PRICE`) would result in an error. To prevent a user from entering the wrong variable type, use the `-TYPE` option with the `READ` command as follows:

```

READ -PROMPT "Number of shares: " -TYPE INTEGER @
SHARES

```

The `-TYPE` option in this example directs the `READ` command to accept only integer values as input. If the user specifies any other

type of value, the Shell will display an error and prompt the user again to enter the proper value.

Other READ commands, like **READC** and **READLN** also enable you to read user input into scripts. For more information on these commands, refer to the *DOMAIN System Command Reference*.

Using Active Functions

You can use **active functions** in scripts to include string output from a command, program, or other script. When you use an active function, the system replaces it with a string containing standard output from the command, program, or script used in the function. Active functions have the following format:

^“command”

where *command* specifies the name of a command, program, or script whose output you want to use. You can use either single or double quotes according to the rules described in the .. Using Quoted Strings” section discussed earlier. Note that output from an active function cannot exceed 1024 characters. If output does exceed this limit, the system displays an error.

You can use active functions in the same way you use variables. For example, suppose you want to use a string that shows the current date and time. (The Shell command DATE displays the current date and time.) By using DATE in an active function, you can substitute the standard output string in the script as follows:

EON
ARGS “The date is ^‘DATE’ ”

In this example, the system substitutes the standard output string from the active function ‘DATE’ to display the following line:

The date is Wednesday, May 1, 1985 10:59:28 (EDT)

Note that the system deletes the trailing CR from the output string; however, any internal CRs remain.

By assigning active functions to variables, you can define your own “Shell functions.” For example, suppose you wrote a program called

GET_PROCESS_NAME that displays the current process name. To make use of this program in a script, you can refer to the program in an active function. For example:

```
EON  
#  
# Assign active function to variable  
#  
PROCNAME := ^"GET_PROCESS_NAME"  
#  
# Execute DM command to make process window  
# invisible  
#  
XDMC "WI -W ^PROCNAME  
#  
# Go off and do something else  
.  
.  
.  
# Make process window visible again  
#  
XDMC "WI -I ^PROCNAME
```

The script in this example assigns the active function to the variable *PROCNAME*. It uses *PROCNAME* with the DM command WI (WINDOW_INVISIBLE) to make the current process window invisible and then visible again. The system substitutes the output string generated by the active function for the variable *PROCNAME*.

Controlling Script Execution

In all of the scripts we've seen in this chapter, the Shell executes each command in sequence, following an unaltered path from the beginning of the script to the end as shown in Figure 9-3. As a result, these scripts perform the same basic operations each time you execute them.

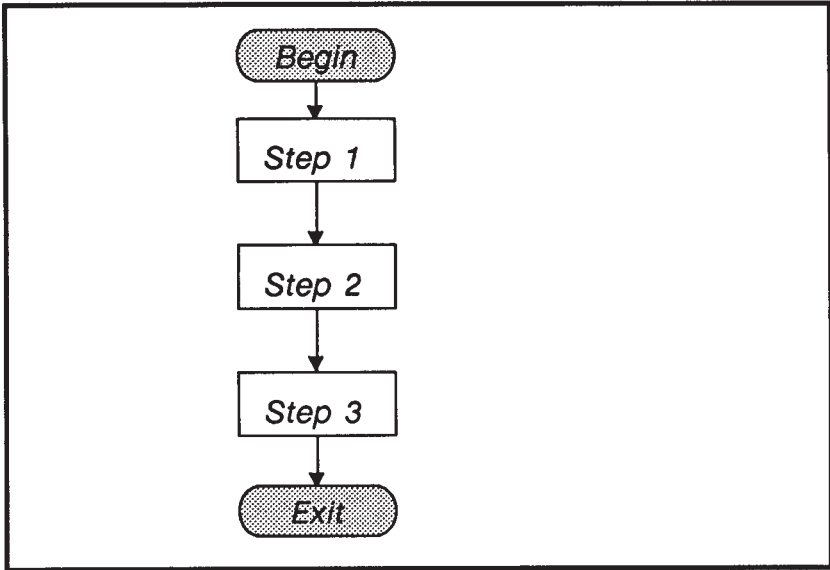

Figure 9-3. Flow of Execution in a Simple Script

You can also create scripts in which the flow of execution varies according to the results of tests performed in the script. To perform these tests in a script, you use **conditional statements**.

Conditional statements test to see if the results of a command or expression are *TRUE* or *FALSE*. Then, based on the result of the test, execute a particular command or sequence of commands. Figure 9-4 shows an example of a conditional statement called an **IF statement**. The IF statement in Figure 9-4 controls the flow of execution by executing *STEP 2* only if the result of the conditional statement is *TRUE*, and executing *STEP 3* if the result is *FALSE*. In this way, the script executes different commands depending on different conditions in the script.

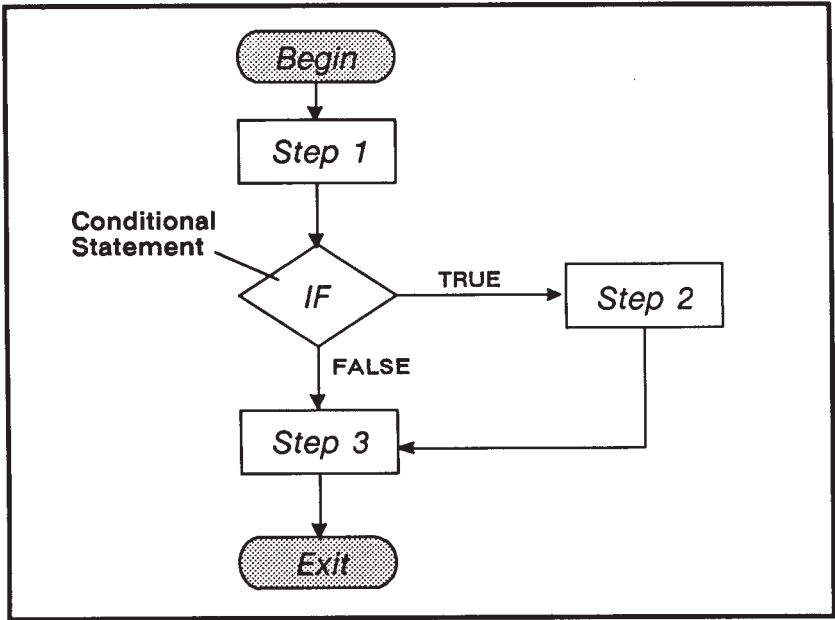

Figure 9-4. Flow of Execution with a Conditional Statement

Figure 9-4 shows a very basic example of how to use an IF statement to control execution. As you'll see later in this section, you can use one or more conditional statements to create more sophisticated flow patterns in scripts.

The Shell supports four different types of conditional statements:

- **IF statement**
- **WHILE statement**
- **FOR statement**
- **SELECT statement**

The sections that follow describe these conditional statements and the commands that execute them.

Using the IF Statement

The **IF** command and all its arguments make up an **IF statement** that executes one or more commands depending on the result of a Boolean test. The IF command has the following format:

```
IF com_1 THEN com_2 ... [ ELSE com_3 ... ] ENDIF
```

where *com_1* specifies a command, program, expression, or Boolean variable you want tested for “truth.” A test of a command or program is *TRUE*, if the command or program executes successfully (returns an abort severity level of zero). A test of an expression or Boolean variable is *TRUE* if they result in a *TRUE* value.

The *com_2* argument specifies one or more commands or expressions to execute if the result of the test on *com_1* is *TRUE*. The *ENDIF* command signifies the end of an IF statement. For example:

```
EON  
IF (( ^A < 100 ))  
THEN ARGS “ ^A is less than 100 ”  
ENDIF
```

The IF statement in this example tests whether the value for variable *A* is less than 100. If the value for *A* is 55, then the result of the test is *TRUE* (the expression results in a *TRUE* value), and the *ARGS* command executes displaying the message:

```
55 is less than 100
```

In this example, if the result of the test is *FALSE*, the next command in the script (following *ENDIF*) executes.

The *com_3* argument, which is optional, specifies one or more commands to execute if the test on *com_1* is *FALSE*. For example:

```
EON  
IF (( ^A < 100 ))  
THEN ARGS “ ^A is less than 100 ”  
ELSE ARGS “ ^A is greater than 100 ”  
ENDIF
```

In this example, if the value of *A* is 900, then the test results in the value *FALSE* (900 is not less than 100). As a result, the *ARGS* command following the *ELSE* statement executes displaying the message:

```
900 is greater than 100
```

When the *IF* statement completes, execution of the script continues sequentially with the next command following *ENDIF*.

Using the WHILE Statement

The **WHILE** command and all its arguments make up a **WHILE statement** that executes one or more commands as long as the result of a Boolean test is *TRUE*. The *WHILE* command has the following format:

```
WHILE com_1 ... DO com_2... ENDDO
```

where *com_1* specifies a command, program, expression, or Boolean variable you want tested for “truth.” A test of a command or program is *TRUE*, if the command or program executes successfully (returns an abort severity level of zero). A test of an expression or Boolean variable is *TRUE* if it results in a *TRUE* value.

The *com_2* argument specifies one or more commands or expressions to execute as long as the result of the test on *com_1* is *TRUE*. For example:

```
i := 0  
WHILE (( ^i < 5 ))  
DO  
  ARGS (( ^i ))  
  i := ( ^i ) +1  
ENDDO
```

The *WHILE* statement in this example tests whether the value for the variable *i* is less than 5. As long as *i* is less than 5, the *ARGS* command displays the value of *i* and the next command adds 1 to its

value. Thus, the `WHILE` statement executes the `ARGS` command 5 times and produces the following display:

```
0
1
2
3
4
```

On the sixth pass, the test results in a *FALSE* value (5 is not less than 5). As a result, the script leaves the `WHILE` “loop” and continues execution at the next command in sequence.

You can also use two special commands with the `WHILE` statement:

- `NEXT`
- `EXIT`

The `NEXT` command returns to the top of the `WHILE` loop. You normally use the `NEXT` command to return prematurely to the top of the loop before executing additional commands. For example, consider the following section from a Shell script:

```
WHILE (( TRUE ))  
DO READ -PROMPT "Enter number: " -TYPE INTEGER A  
IF (( ^A < 50 )) THEN NEXT ENDIF  
ARGS (( ^A ))  
ENDDO
```

This `WHILE` loop executes three commands:

- A `READ` command to read in an integer value.
- An `IF` command to test whether the value is less than 50.
- An `ARGS` command to display the value.

If the integer value is greater than 50, the `IF` statement is *FALSE* and the next command (`ARGS`) executes. If the value is less than 50, however, the `IF` statement is *TRUE* and the `NEXT` command executes, returning execution to the top of the `WHILE` loop. As a

result, this section of the script displays any value that is greater than 50.

The **EXIT** command exits the **WHILE** loop. You normally use the **EXIT** command to exit a **WHILE** loop prematurely before executing additional commands. For example:

```
WHILE (( TRUE ))  
DO READ -PROMPT "Enter number: " -TYPE INTEGER A  
IF (( ^A < 50 )) THEN EXIT ENDIF  
ARGS (( ^A ))  
ENDDO  
ARGS "Finished"
```

The **WHILE** loop in this example is very similar to the loop in the previous example, except that the **IF** statement uses the **EXIT** command instead of **NEXT**. If the integer value is greater than 50, the **IF** statement is *FALSE*, and the command (**ARGS**) executes. If the value is less than 50, however, the **IF** statement is **TRUE**, and the **EXIT** command executes.

The **EXIT** command causes execution to exit the **WHILE** loop and skip to the next command outside the loop (after **ENDDO**). As a result, this section of the script displays any value that is greater than 50, but exits the loop if you enter a value less than 50.

Using the **FOR** Statement

The **FOR** command and all its arguments make up a **FOR statement** that executes commands as long as the result of a **-Boolean** test is true. The **FOR** command has two formats: one for using integer expressions, and one for using string expressions.

The **FOR** command used with integer expressions has the following format:

```
FOR variable := exp_1 [ TO exp_2 ] [ BY exp_3 ]  
command ...  
ENDFOR
```

where *exp_1*, *exp_2*, and *exp_3* are all expressions that result in integer values. The *exp_1* argument specifies the initial integer value assigned to variable.

The *command* argument specifies one or more commands to execute as long as the test on *variable* results in a *TRUE* value. Before each iteration, the FOR statement tests to see if the current variable value is less than the value specified by *exp_2*. As long as the variable value is less than the value for *exp_2*, the result is *TRUE*.

Like the WHILE statement, you can use the FOR statement to execute commands repetitively in a loop. The FOR statement is different, however, because it increments its variable automatically after each iteration. For example, the WHILE and FOR statements in the following example perform the same operation:

#Example using WHILE Statement

```
#  
A:= 0  
WHILE (( A <= 10 )) DO  
    ARGS AA  
    A := ^A + 2  
ENDDO
```

```
#  
#  
#Example using the FOR statement
```

```
#  
FOR A := 0 TO 10 BY 2  
    ARGS ^A  
ENDFOR
```

In this example, both the WHILE loop and the FOR loop execute the ARGS command six times. By default, the FOR statement increments the value of the variable by one after each iteration. Notice, however, that this example uses *BY 2* to increment the variable by

two after each iteration. Instead of the FOR loop counting from 0 to 10 by 1, it counts to 10 by 2. The result is:

```
0
2
4
6
8
10
```

The FOR command used with string expressions has the following format:

```
FOR variable IN exp [ BY [ CHAR ] [ WORD ] [ LINE ] ]  
command ...  
ENDFOR
```

where *exp* specifies a string expression. By default, during each iteration, FOR reads a word from the string and assigns it to *variable*. You can also direct FOR to read the string by character or line by specifying BY with the appropriate option.

The *command* argument specifies one or more commands to execute as long as the test on *variable* results in a *TRUE* value. Before each iteration, the FOR statement tests to see if any more characters, words, or lines exist (depending on the *BY* argument specified). As long as a value exists to assign to the variable, the result is *TRUE*. For example:

```
EON  
FOR FILE IN "foo bar zap" BY WORD  
  ARGS "The current file is ^FILE"  
ENDFOR
```

In this example, with each pass through the FOR loop, FOR assigns the variable *FILE* a word from, the string. When FOR runs out of words, it exits. As a result, the FOR statement in this example displays the following lines then exits:

```
The current file is foo  
The current file is bar  
The current file is zap
```

Using the SELECT Statement

The **SELECT** command and all its arguments make up a **SELECT statement** that executes commands according to the results of one or more Boolean tests. The **SELECT** command has the following format:

```
SELECT arg_1 [ ONEOF | ALLOF ]
    CASE arg [ TO arg ]
        commands ...
    [ CASE ...
        commands ... ]
    [ OTHERWISE
        commands ... ]
ENDSELECT
```

where *arg_1* specifies the argument that **SELECT** compares to the **CASE** argument, *arg*. All arguments are either integers, strings, variables, or expressions.

The Shell uses each **CASE** statement to perform a separate Boolean test on the initial **SELECT** argument. If the **CASE** argument is equal to the **SELECT** argument, the result of the test is *TRUE*, and the command following the **CASE** statement executes. Let's look at a simple example:

```
EON
SELECT ^A ALLOF
    CASE 1
        ARGS "First case will execute if ^A = 1 "
    CASE (( 2 + 4 ))
        ARGS "Second case will execute if ^A = 6 "
    CASE 6
        ARGS "Third case will execute if ^A = 6 "
ENDSELECT
```

In this example, the first case tests to see if the variable *A* equals *1*, and the second and third cases test to see if *A* equals *6*. The **ALLOF** statement directs **SELECT** to execute the commands associated with all cases that result in *TRUE*. If *A* is *6*, the **SELECT** statement in

this example executes the commands for the second and third case to display the following:

Second case will execute if 6 = 6

Third case will execute if 6 = 6

If you specify **ONEOF** (the default), **SELECT** executes only the first case that results in a *TRUE* value. In the previous example, where *A* equals 6, **SELECT** executes only the second case to display the following:

Second case will execute if 6 = 6

You can also use the **NEXT** and **EXIT** commands to control execution within the **SELECT** statement. For example, when using **ONEOF** you can use the **NEXT** statement to direct **SELECT** to execute another case as shown in the following example:

```
EON  
SELECT ^A ONEOF  
  CASE 1  
    ARGS "First case will execute if ^A = 1 "  
    NEXT  
  CASE (( 2 + 4 ))  
    ARGS "Second case will execute if ^A = 6 "  
    NEXT  
  CASE 6  
    ARGS "Third case will execute if ^A = 6 "  
ENDSELECT
```

In this example, if variable *A* equals 6, the second **CASE** executes. Although this script uses **ONEOF**, the **NEXT** command following the second case directs **SELECT** to execute the next case that's *TRUE*. Since the third case is *TRUE*, the script in this example executes the third case.

Using the **TO** statement, you can specify a range for a case argument. The case in the following script tests for a value in the range of 1 to 10:

```
EON
SELECT ^A ALLOF
    CASE 1 TO 10
        ARGS "Variable A is the number ^A"
ENDSELECT
```

You can also use the *TO* statement to test for a range of string characters. For example:

```
EON
SELECT ^A ALLOF
    CASE a TO z
        ARGS "Variable A is the letter ^A"
ENDSELECT
```

The case in this example tests for a string value between *a* and *z*. Note that this range is case-sensitive, so the case is *TRUE* for example, if *A* equals *r* but not *R*.

Use the *OTHERWISE* statement when you want to perform an operation if the test on a case is *FALSE*. For example:

```
EON
SELECT ^A ALLOF
    CASE 0 TO 10
        ARGS "Value for A is a number from 0 to 10"
    OTHERWISE
        ARGS "Value for A is greater than 10"
ENDSELECT
```

In this example, if the value for *A* is a number between 1 and 10, the case is *TRUE*. As a result, *SELECT* displays the following:

Value for A is a number from 1 to 10

If the value is a number greater than 10, the case is *FALSE*, and the command following *OTHERWISE* executes displaying the following:

Value for A is greater than 10

If you include several cases on the same line, *SELECT* separates each case with an implied *OR* operator (see the “Logical Operators” section discussed earlier). You can also use the *@* character to es-

cape NEWLINE characters and continue an “ORed” case on more than one line. For example:

```
EON  
SELECT ^A  
    CASE 1 CASE 3 CASE 5  
        ARGS “Variable A matches 1, 3, or 5”  
    CASE 2 @  
    CASE 4 @  
    CASE 6  
        ARGS “Variable A matches 2, 4, or 6”  
ENDSELECT
```

Initial Directory and File Structure

The following illustrations show how the system organizes the software that we supply with your node:

- Figure A-1 shows the contents of the node entry directory (*/*)
- Figure A-2 shows the files and directories in the system software directory (*/SYS*)
- Figure A-3 shows the files and directories in the Display Manager directory (*/SYS/DM*)
- Figure A-4 shows the network management directory (*/SYS/NET*)

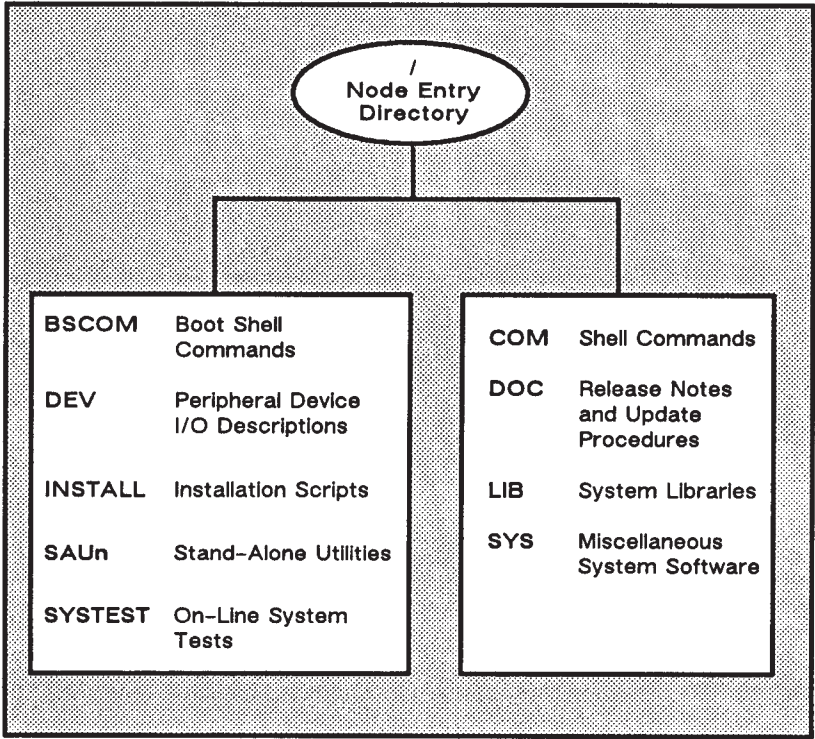

Figure A-1. The Node Entry Directory (/) and Subdirectories

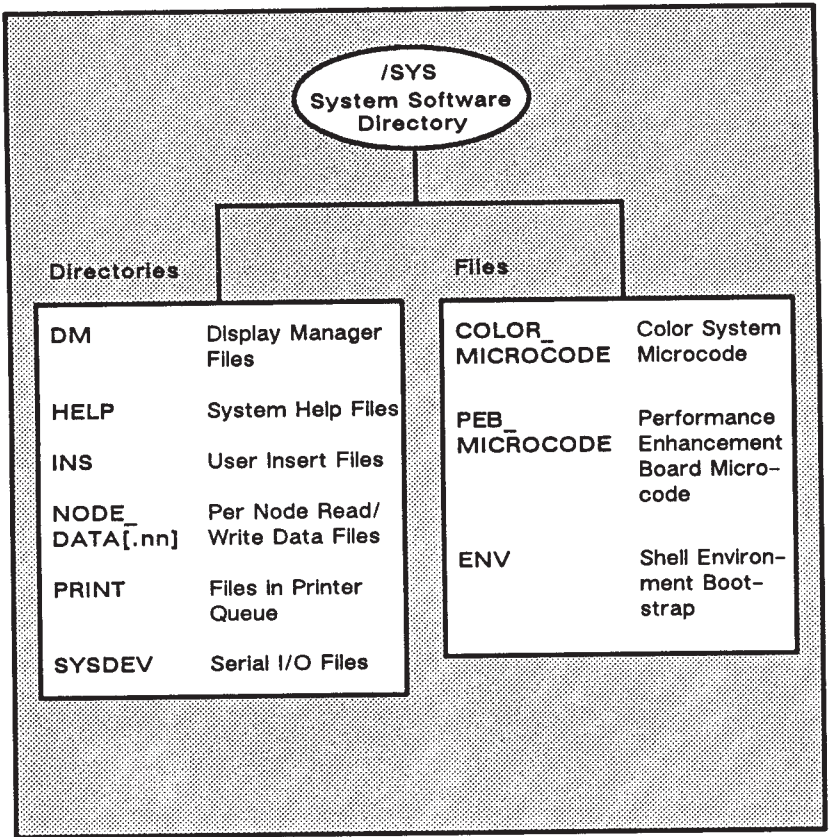

Figure A-2. The System Software Directory (/SYS)

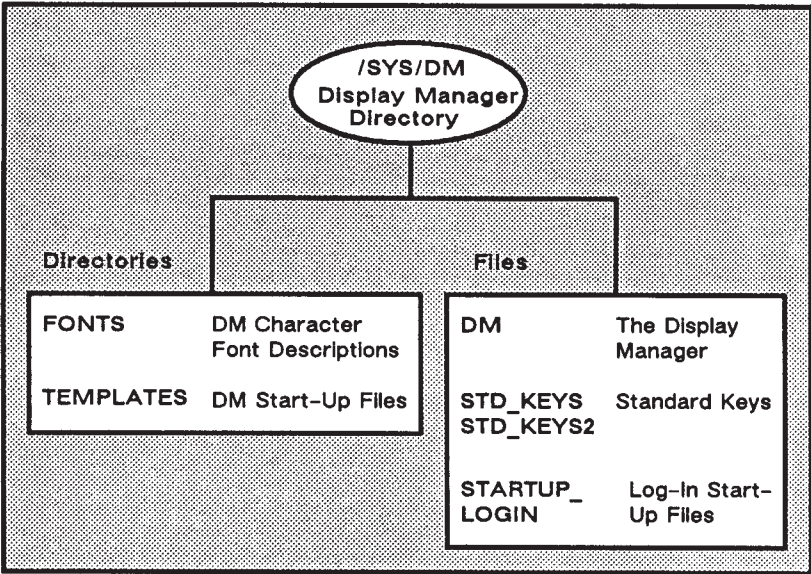

Figure A-3. The Display Manager Directory (/SYS/DM)

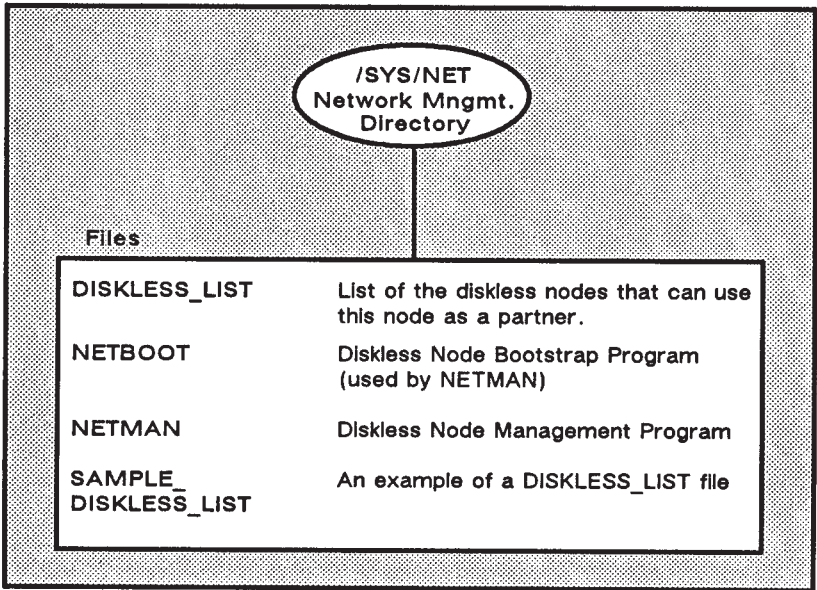

Figure A-4. The Network Management Directory (/SYS/NET)

Summary of Predefined Key Definitions

The tables presented in this appendix describe the predefined key definitions for both the 880 and low-profile type keyboards. The 880 keyboard is an older style keyboard that we no longer ship with new nodes. Figure B-1 shows the names and locations of the keys on the 880 keyboard.

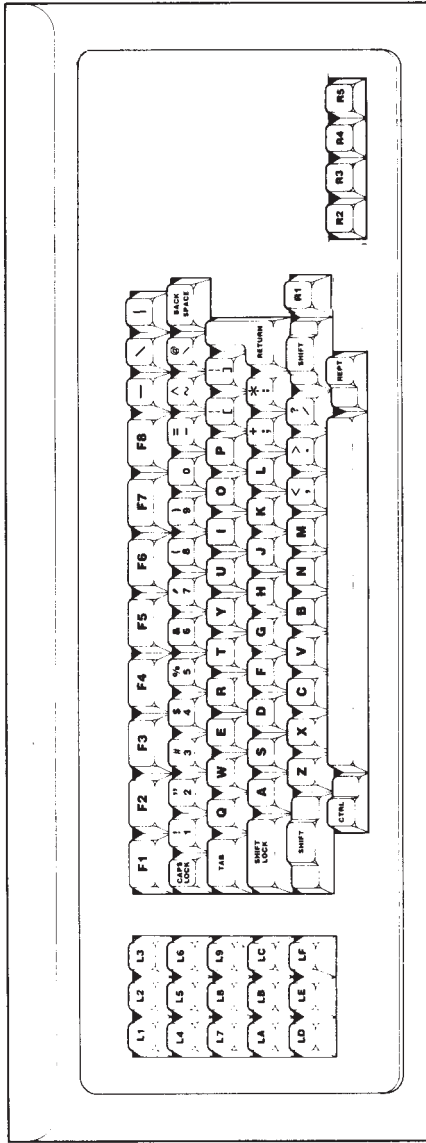

Figure B-1. Keynames for the 880 Keyboard

Controlling the Cursor

Task	DM Command	Predefined Key	
		Low-Profile	880
Move left one char.	AL	← (LA)	← (LA)
Move right one char.	AR	→ (LC)	→ (LC)
Move up one line	AU	↑ (LB)	↑ (LB)
Move down one line	AD	↓ (LE)	↓ (LE)
Set arrow key scale factors	AS x y	None	None
Move to the beginning of line	TL	⌠ (L4)	⌠ (L4)
Move to end of line	TR	⌡ (L6)	⌡ (L6)
Move to top line in window	TT	<SHIFT> ↑ (LDS)	None
Move to bottom line in window	TB	<SHIFT> ↓ (LFS)	None
Tab to window borders	TWB [l, r, t, b]	None	None
Move to the beginning of next line	AD;TL	CTRL/K	CTRL/K
Tab left	THL	CTRL/<TAB>	CTRL/<TAB>
Tab right	TH	<TAB>	<TAB>
Set tabs	TS [n1 n2 ...]	None	None

Controlling the Cursor (continued)

Task	DM Command	Predefined Key	
		Low-Profile	880
Move to DM input pad	TDM	<CMD> (L5)	<CMD> (L5)
Move to next window on screen	TN	<NEXT WNDW> (LB)	<NEXT WNDW> (LB)
Move to previous window	TLW	CTRL/L	CTRL/L
Move to next window in which input is enabled	TI	None	None

Creating Processes

Task	DM Command	Predefined Keys	
		Low-Profile	880
Create new process, pads, and windows	CP pathname	<SHELL> (L5S)	<SHELL> (R2)
Create new process without pads or windows	CPO pathname	None	None
Create a server process	CPS pathname	None	None

Controlling Processes

Task	DM Command	Predefined Key	
		Low-Profile	880
Quit, stop, or blast a process	DQ [-b -s -c nn]	CTRL/Q	CTRL/Q
Suspend execution of a process	OS	None	None
Resume execution of a suspended process	DC	None	None

Creating Pads and Windows

Task	DM Command	Predefined Key	
		Low-Profile	880
Create an edit pad and window	CE pathname	<EDIT> (R4)	<EDIT> (R4)
Create a read-only window	CV pathname	<READ> (R3)	<READ> (R3)
Create a copy of an existing pad and window	CC	None	None









Closing Pads and Windows

Task	DM Command	Predefined Key	
		Low-Profile	880
Close window and pad; update file	PW; WC -Q	<EXIT> (R5)	CTRL/Y
Close window and pad; no update	WC -Q	<ABORT> (R5S)	CTRL/N
Close (delete) a window	WC [-Q -F]	None	None

Managing Windows

Task	DM Command	Predefined Key	
		Low-Profile	880
Changing window size	WG	CTRL/G	None
Changing window size with rubberbanding	WGE	<GROW> (LA3)	CTRL/G
Move a window	WM	None	None
Move a window with rubberbanding	WME	<MOVE> (LA3S)	CTRL/W
Set scroll mode	WS [-on -off]	CTRL/S	CTRL/S
Set autohold mode	WA [-on -off]	None	None
Scroll and autoholdmode	WA;WS	CTRL/A	CTRL/A
Set hold mode	WH [-on -off]	<HOLD> (R6)	<HOLD/GO> (R5)

Moving Pads

Task	DM Command	Predefined Key	
		Low-Profile	880
Move top of pad into window	PT	None	None
Move cursor to first character in pad	PT;TT;TL	CTRL/T	CTRL/T
Move bottom of pad into window	PB	None	None
Move cursor to last character in pad	PB; TB; TR	CTRL/B	CTRL/B
Move pad n pages	PP [-]n	  (LD, LF)	  (LD, LF)
Move pad n lines	PV [-]n	<SHIFT> ↑ (L8S)	(F2)
		<SHIFT> ↓ (LES)	(F3)
Move pad n characters	PH [-]n	  (L7, L9)	  (L7, L9)
Save transcript pad in a file	PN	None	None

Controlling Window Groups and Icons

Task	DM Command	Predefined Key	
		Low-Profile	880
Create or add to a window group	WGRA grp-name [entry_name]	None	None
Remove a window from a window group	WGRR grp_name [entry-name]	None	None
Make windows invisible	WI [entry_name]	None	None
Change windows to icons	ICON [entry_name] [character]	None	None
Set icon positioning and offset	IDF	None	None
Display list of windows in group	CPS group_name	None	None

Setting Edit Modes

Task	DM Command	Predefined Key	
		Low-Profile	880
Set read/write mode	RO [-ON -OFF]	CTRL/M	CTRL/M
Set insert/overstrike mode	EI [-ON -OFF]	<INS> (LIS)	<INS MODE> (L1)

Inserting Characters

Task	DM Command	Predefined Key	
		Low-Profile	880
Insert string at cursor	ES 'string'	<i>Default DM operation</i>	
Insert NEWLINE character	EN	<RETURN>	<RETURN>
Insert a new line after current line	TR;EN;TL	<F1>	<F1>
Insert end-of-file mark	EEF	CTRL/Z	CTRL/Z

Deleting Text

Task	DM Command	Predefined Key	
		Low-Profile	880
Delete character at cursor	ED	<CHAR DEL> (L3)	<CHAR DEL> (L3)
Delete character before cursor	EE	<BACKSPACE> (BS)	<BACKSPACE> (BS)
Delete "word" of text	DR;/[~A-Z0-9\$_]/XD	<F6>	<F6>
Delete from cursor to end of line	ES ";EE;DR;TR;XD;TL;TR	<F7> (L3A)	<F7> (L3A)
Delete entire line	CMS;TL;XD	<LINE DEL> (L2)	<LINE DEL> (L2)

Copying, Cutting, and Pasting Text

Task	DM Command	Predefined Key	
		Low-Profile	880
Copy text to a paste buffer or file	XC [name -f pathname] [-R]	<COPY> (L1A)	CTRL/C
Cut (delete) text and write it to a paste buffer or file	XD [name -f pathname] [-R]	<CUT> (L1AS)	CTRL/E
Paste (write) text from a paste buffer or file into a pad	XP [name -f pathname] [-R]	<PASTE> (L2A)	CTRL/O

Commands for Searching for Text

Task	DM Command	Predefined Key	
		Low-Profile	880
Search forward for string	/string/	None	None
Search backward for string	\string\	None	None
Repeat last forward search	//	CTRL/R	CTRL/R
Repeat last backward search	\\	CTRL/U	CTRL/U
Cancel search or any action involving the ECHO command	ABRT	CTRL/X	CTRL/X
Set case comparison for search	SC [-ON] [-OFF]	None	None

Commands for Substituting Text

Task	DM Command	Predefined Key	
		Low-Profile	880
Substitute <i>string2</i> for all occurrences of <i>string1</i> in a defined range	S/string1/string2	None	None
Substitute <i>string2</i> for the first occurrence of <i>string1</i> in each line of a defined range	SO/string1/string2/	None	None
Change case of each letter in a defined range	CASE [-S] [-U] [-L]	None	None

Index

The letter *f* means “and the following page”; the letters *ff* mean “and the following pages.” Symbols are listed at the beginning of the index. Task oriented entries appear in color.

Symbols

- { } (braces)
 - as pathname wildcard characters 6-21
 - in regular expressions 5-21
- (()) (double parentheses)
 - as expression delimiters 9-12
- () (parentheses)
 - as pathname wildcard characters 6-21
- & (ampersand)
 - as input request character 3-5, 3-20
 - as Shell parsing operator 6-22
- * (asterisk)
 - as EDACL prompt 8-9
 - as multiplication operator 9-14
 - as pathname wildcard character 6-18f
 - in regular expressions 5-18
 - reading pathnames from standard input 6-17
- @ (at sign)
 - escape character
 - In DM commands 3-5
 - in Shell commands 6-4
 - in regular expressions 5-21
- \ (backslash)
 - beginning pathnames 1-12f
 - to search backwards for text 5-23
- ~ (tilde)
 - beginning pathnames 1-11
- ^ (caret)
 - as substitution character 9-4, 9-19
 - in active functions 9-24
- \$ (dollar sign)
 - as Shell command prompt 6-2
 - in regular expressions 5-17
- \\ (double backslash)
 - to repeat search backwards 5-25
- >> (double greater-than)
 - appending files 7-10f
 - appending standard output 6-12
- >>? (double greater-than/question mark)
 - appending error output 6-13
- << (double less-than)
 - redirecting standard input 9-9
- // (double slash) 1-4
 - in absolute pathnames 1-7
 - to repeat search forward 5-25
- ... (ellipsis)
 - as pathname wildcard character 6-20
- = (equal sign)
 - as comparison operator 9-17
 - as pathname wildcard character 6-21
- ! (exclamation mark)
 - as substitution character 9-7
- > (greater-than)
 - as comparison operator 9-16
 - redirecting standard output 6-12
- >? (greater-than/question mark)
 - redirecting error output 6-12
- (hyphen)
 - preceding DM command options 3-4
 - preceding Shell command options 6-3
 - reading data from standard input 6-17
- < (less-than)
 - as comparison operator 9-17
 - redirecting standard input 6-11
- % (percent sign)
 - as pathname wildcard character 6-18f
 - as SID wildcard 8-3, 8-11
 - In regular expressions 5-17
- # (pound sign)
 - in DM commands 3-5
 - in Shell commands 9-2
- ? (question mark)
 - as pathname wildcard character 6-18f
 - in regular expressions 5-18
- ;(semicolon)
 - separating DM commands 3-5
 - separating Shell commands 6-4
- / (slash) 1-4
 - beginning pathnames 1-8
 - to search forward for text 5-23

- [] (square brackets)
 - as pathname wildcard character 6-19
 - in regular expressions 5-19
- ~ (tilde)
 - as pathname wildcard character 6-20
 - in regular expressions 5-19
- | (vertical bar)
 - as pipe 6-13

A

- AA (Acknowledge alarm) command 4-26
- ABORT key 4-7, 4-16
- ABRT (ABORT) command 4-19, 4-20
- absolute pathname 1-7, 7-6
- Access Control List (see ACL)
- access rights 8-12
 - class names 8-14
 - denying 8-4, 8-12
 - EXPUNGE 8-7
 - for backup files 8-14
 - in ACL entries 8-2
 - in ACL entries 8-4
 - SEARCH 8-7
 - types for directories 8-6
 - types for files 8-6
- ACCOUNT
 - components 2-21
 - default account (USER) 2-20
 - file 2-15
 - initial naming directory 2-15
 - initial working directory 2-15
 - updating 2-21
 - verification at login 2-15
- ACL (Access Control List) 8-1ff
- ACL (ACCESS_CONTROL_LIST)
 - command 8-7
 - copying initial ACLs 8-21f
 - copying ACLs 8-18
 - displaying ACLs 8-8
- ACLs
 - access rights
 - adding 8-16
 - changing 8-15
 - class names 8-14
 - deleting 8-17
 - for backup files 8-14
 - commands for editing and copying 8-9, 8-20
 - copying 8-21
 - displaying 8-8
 - editing 8-9, 8-20

- entries 8-2
 - adding 8-15
 - deleting 8-17
 - rights element 8-2
 - SID element 8-2f
 - rules for specifying 8-11f
- initial 8-18f
- managing 8-7f
- on new files 7-6
- sample display 8-8
- structure 8-2
- valid access rights 8-12
- active functions 9-24f
 - assigning to variables 9-24
- adding
 - ACL access rights 8-16
 - ACL entries 8-15
- alarm server
 - running in a process 4-7
- alarms
 - responding to 4-26
- ALL_GROUP paste buffer 4-38
- ampersand (&)
 - as input request character 3-5, 3-20
 - as Shell parsing operator 6-22
- AP (Acknowledge alarm and pop) 4-26
- appending
 - directories to command search rules 6-6
 - error output to files 6-13
 - files 7-10f
 - standard output to files 6-12f
- ARGS (ARGUMENTS) command 9-4
- arguments
 - in DM commands 3-4
 - in Shell commands 6-3
 - passing to Shell scripts 9-4ff
- ASCII characters
 - in regular expressions 5-17
- assigning
 - protected subsystem status to files 8-27
- asterisk (*)
 - as EDAcl prompt 8-9
 - as multiplication operator 9-14
 - as path name wildcard character 6-18f
 - in regular expressions 5-18
 - reading pathnames from standard input 6-17
- at Sign (@)
 - escape character
 - in Shell commands 6-4
 - in regular expressions 5-21
- autohold mode 4-23f

B

- BACK SPACE key 5-8
- background processes 6-22
 - creating 4-7
- backslash
 - to search backwards for text 5-23
- backup files 4-17, 5-30
 - access rights 8-14
- BOFF command 6-22
- BON command 6-22
- Boolean values
 - comparing 9-17
 - in expressions 9-14
 - logical operations 9-17
- boot script 2-4, 2-11
 - creating processes from 4-7
 - editing 2-7
 - invoking CPS commands from 4-8
 - node-specific 2-11
 - used by DSPs 2-7
- boot volume 1-3
 - sharing by nodes 1-3
- booting
 - operating system on disked nodes 2-4
 - operating system on diskless nodes 2-10
- braces ({ })
 - as path name wildcard characters 6-21
 - in regular expressions 5-21
- buffers
 - for window groups 4-37
 - paste (see paste buffers)
 - undo 5-29

C

- cancelling
 - search operations 5-25
 - window grow operation 4-19
 - window move operation 4-20
- caret (^)
 - as substitution character 9-4, 9-19
 - in active functions 9-24
- CASE (CHANGE_CASE) command 5-28
- case
 - changing 5-28
- case companion
 - setting 5-25

- CASE statement 9-34
- cataloging nodes 1-5f
- CATF (CATENATE_FILE) command 6-12
- CATF (CATENATE_FILES) command 7-10f
- CC (CREATE_COPY) command 4-15
- CE (CREATE_EDIT) command 4-13, 7-6
- changing
 - ACL access rights 8-15
 - case of letters 5-28
 - command search rules 6-7
 - naming directory 7-4
 - process window modes 4-22ff
 - size of windows 4-18f
 - working directory 7-3
- CHAR DEL key 5-7
- character class 5-19
- characters
 - ASCII control 3-16
 - ASCII
 - in regular expressions 5-17
 - control key 3-16
 - deleting from pads 5-7f
 - DM function 3-16
 - end-of-line 5-17
 - in regular expressions 5-17ff
 - inserting into pads 5-4ff
 - I/O control 6-11
 - matching with regular expressions 5-18
 - mouse 3-16
 - ordinary 3-16
 - program function 3-16
 - Shell command line limit 6-4
 - special Shell 6-7
- CHN (CHANGE_NAME) command
 - changing directory names 7-21
 - changing file names 7-7
 - changing link names 7-34
- class names 8-12
- closing
 - pads and windows 4-7, 4-16
- CMD key 3-2
- CMDF (COMMAND_FILE) command 2-17, 3-22
- CMF (COMPARE_FILE) command 7-19
- CMT (COMPARE_TREE) command 7-27
- /COM directory 6-5
- ~COM directory 7-3, 9-3
- command line parser 6-14ff
- command parser options 6-15
- command search rules 6-2, 6-5ff

- appending directories to 6-6
 - changing 6-7
 - default 6-5
 - displaying 6-6
- commands
 - DM (see DM commands)
 - for changing Shell variables 9-21
 - for closing pads and windows 4-16
 - for controlling edit pad modes 5-2
 - for controlling window groups 4-31
 - for controlling window icons 4-31
 - for copying text 5-11, 5-11
 - for creating pads and windows 4-10
 - for creating processes 4-5
 - for cutting text 5-11, 5-11
 - for deleting Shell variables 9-21
 - for deleting text from pads 5-7
 - for editing ACLs 8-10
 - for editing and copying initial ACLs 8-20
 - for inserting characters into pads 5-5
 - for managing ACLs 8-7
 - for managing directories 7-20
 - for managing files 7-5
 - for managing links 7-31
 - for managing windows 4-17
 - for moving cursor 4-2f
 - for moving pads under windows 4-27
 - for pasting text 5-11, 5-11
 - for searching for text 5-23
 - for setting directories 7-2
 - for substituting text 5-26
 - for verifying Shell variables 9-21
 - Shell (see Shell commands)
 - undoing 5-29
- comments
 - in DM command scripts 3-5
 - in Shell scripts 9-2
- comparing
 - ASCII files 7-19
 - Boolean values 9-17
 - directory trees 7-27f
- comparison operators 9-16f
- components
 - in Shell command line 6-3
- concatenating strings 9-15
- conditional statements 9-26
 - types 9-27
- continuing
 - Shell commands 6-4
- control characters 6-11
- control key sequences
 - predefined 3-10f
 - to invoke DM commands 3-3, 3-10ff
- controlling
 - access to protected subsystem files 8-24
 - command queries 6-15
 - cursor movement 4-2f
 - edit pad modes 5-2
 - icons 4-33ff
 - Shell command input and output 6-9f
 - Shell script execution 9-25ff
 - the display 3-2, 4-1ff
 - window groups 4-31ff
- conventions
 - for DM commands 3-4
 - for naming keys 3-15ff
 - for Shell command lines 6-3f
- COPY key 3-15
- copying
 - ACLs 8-18
 - directory trees 7-22ff
 - display images to files 5-13
 - display to files 7-18f
 - files 7-8
 - initial ACLs 8-21
 - links 7-35
 - pads and windows 4-15
 - text from pads 5-12
- CP (CREATE_PROCESS) command 4-5
- CPB (COPY_PASTE_BUFFER) command 4-37
- CPF (COPY_FILE) command 7-8
- CPL (COPY_LINK) command
 - copying links 7-35
 - replacing links 7-35f
- CPO (CREATE_PROCESS_ONLY) command 4-7
- CPS (CREATE_SERVER_PROCESS) command 4-8
- CPSCR (COPY_SCREEN) command 7-18
- CPT (COPY_TREE) command
 - copying trees 7-23
 - merging trees 7-26
 - replacing trees 7-25
- CRO (CREATE_DIRECTORY) command 7-2f
- creating
 - directories 7-21
 - edit pads and windows 4-13
 - files 7-5
 - icons 4-35
 - links 7-32
 - new files 4-13
 - pads 4-10ff

- paste buffers 5-11
 - processes 4-4
 - processes running the Shell 4-6
 - processes
 - with pads and windows 4-5f
 - processes without pads and windows 4-7
 - protected subsystems 8-26
 - server processes 4-8
 - Shell scripts 9-2f
 - Shells 6-7f
 - subordinate Shells 6-8
 - window groups 4-31f
 - windows 4-10ff
 - CRL (CREATE_LINK) command
 - creating links 7-32
 - redefining links 7-33
 - CRSUBS (CREATE_SUBSYSTEM) command 8-26
 - CSR (COMMAND_SEARCH_RULES) command 6-6
 - CTNODE (CATALOG_NODE) command 1-5f
 - CTRL/A key 4-25
 - CTRL/B key 4-28
 - CTRL/E key 5-14
 - CTRL/M key 4-14, 5-3
 - CTRL/N key 4-7, 4-16
 - CTRL/P key 4-22
 - CTRL/Q key 4-9
 - CTRL/R key 5-25
 - CTRL/S key 4-24
 - CTRL/T key 4-28
 - CTRL/U key 5-25
 - CTRL/X key 4-19, 5-25
 - CTRL/Y key 4-17.5-30,7-5
 - CTRL/Z key 4-7, 5-6, 6-17
 - saving EDACL changes 8-10
 - cursor
 - controlling movement 4-2f
 - defining display points 3-2, 3-6
 - CUT key 3-15, 5-14
 - cutting
 - text from pads 5-14
 - CV (CREATE_VIEW) command 3-10 3-11, 4-14
- D**
- DATE command 6-2 9-24
 - DC (DEBUG_CONTINUE) command 4-10
 - debugging
 - Shell scripts 9-10f
 - default
 - access rights 8-7
 - account (USER) 2-20
 - ACLs 8-18f
 - command search rules 6-5f
 - icon position and offset 4-36
 - icons 4-35
 - paste buffer 5-11
 - paste buffers
 - writing text to 5-8
 - window positions 4-25
 - defining
 - a range of text in pads 5-9f
 - default window positions 4-25
 - display points 3-6ff
 - display regions 3-6ff
 - keys 3-18ff
 - at startup 2-7
 - at startup 2-11
 - at start-up 3-12ff
 - from within a program 3-18
 - from within a program 3-22
 - to prompt for input 3-20
 - Shell
 - environment 6-8f
 - variables 9-18
 - variables interactively 9-22f
 - deleting
 - ACL
 - access rights 8-17
 - entries 8-17
 - characters from pads 5-7f
 - directory trees 7-30
 - edit pads and windows 4-16
 - entries from window groups 4-32f
 - files 7-18
 - key definitions 3-21
 - lines of text from pads 5-8
 - links 7-36
 - NEWLINE characters from pads 5-7
 - paste buffers 5-11
 - read-only pads and windows 4-16
 - text from pads 5-7ff, 5-14
 - windows 5-7
 - words from pads 5-8
 - delimiters
 - for DM command lines 3-4
 - derived-name
 - in path name wildcards 6-21
 - /DEV/NULL 6-22
 - directories
 - appending to command search rules 6-6
 - /COM 6-5
 - ~COM 6-5, 7-3, 9-3
 - commands for managing 7-20

- comparing 7-27f
- copying trees 7-22ff
- creating 7-21
- deleting trees 7-30
- displaying information 7-28f
- EXPUNGE rights 8-7
- for personal commands 9-3
- initial ACLs 8-18f
- log-in home 2-15
- managing 7-20ff
- merging 7-26f
- naming 1-11
 - changing 7-4
 - setting 7-3
- network root 1-4f
- node entry 1-4f
- parent 1-12f
- protecting 8-1ff
- queue 7-12
- renaming 7-21f
- replacing trees 7-25f
- SEARCH rights 8-7
- site registry 2-21
- /SYS 1-5
- upper-level 1-4
- valid access rights 8-12
- working 1-9f, 7-2
 - changing 7-3
 - setting 7-3
- directory tree 7-23
- disked node 1-3
 - as network partner 2-9
 - booting 2-4
 - 'NODE_DATA 2-11
 - start-up 2-2ff
- diskless list 2-10
- diskless node 1-3
 - 'NODE_DATA 2-4
 - start-up 2-8ff
- display
 - controlling with DM commands 3-2ff
 - copying images to files 5-13
 - defining points 3-2, 3-6ff
 - defining regions 3-2, 3-6ff
 - drawing initial windows 2-7
- Display Manager (DM) 1-3, 2-4, 2-10, 3-1ff
- display
 - printing images 5-14, 7-18f
- displaying
 - ACLs 8-8
 - command search rules 6-6
 - current naming directory 7-3
 - current working directory 7-3
 - directory information 7-28f
 - file attributes 7-16f
 - key definitions 3-21
 - link resolution names 7-33
 - naming directory 7-3
 - window group members 4-37
- DLDUPL (DELETE DUPLICATE_LINES)
 - command 6-13f
- DLF (DELETE_FILE) command 1-6, 7-18
- DLL (DELETE_LINK) command 7-36
- DLT (DELETE_TREE) command 7-30
- DLVAR (DELETE_VAR) command 9-21f
- DM command scripts 3-22f
- DM commands
 - AA (Acknowledge alarm) 4-26
 - ABRT (ABORT) 4-19, 4-20
 - AP (Acknowledge alarm and pop) 4-26
 - CASE (Change case) 5-28
 - CC (CREATE_COPY) 4-15
 - CE (CREATE_EDIT) 4-13, 7-6
 - CMDF (COMMAND_FILE) 3-22
 - conventions 3-4
 - CP (CREATE_PROCESS) 4-5
 - CPB (COPY_PASTE_BUFFER) 4-37
 - CPO (CREATE_PROCESS_ONLY) 4-7
 - CPS (CREATE_SERVER_PROCESS) 4-8
 - CV (CREATE_VIEW) 3-10, 3-11, 4-14
 - DC (DEBUG_CONTINUE) 4-10
 - DQ (DEBUG_QUIT) 4-9
 - DR 3-9, 4-15
 - DS (DEBUG_SUSPEND) 4-10
 - ED (Delete character at cursor) 5-7
 - EE (Delete character before cursor) 5-8
 - EEF (Insert end-of-file) 5-6
 - EI (Set insert/overstrike mode) 4-24, 5-4
 - EN (Insert NEWLINE) 5-6
 - ES (Insert string) 5-5
 - executing from a script 2-18
 - executing from scripts 3-22f
 - executing from Shell scripts 9-10
 - format 3-4
 - ICON 4-34
 - IDF (ICON_DEFAULT) 4-36
 - KD (KEY_DEFINITION) 3-18
 - PB (PAD_BOTTOM) 4-28

- PN (PAD_NAME) 4-30
 - PP (PAD_PAGE) 4-28
 - prompt 3-2
 - PT (PAD_TOP) 4-28
 - PV (PAD_LINE) 4-29
 - PW (PAD_WRITE) 5-30
 - RO (READ_ONLY) 5-3
 - RO (Set read/write mode) 4-14
 - S (SUBSTITUTE) 5-27
 - SC (Set case comparison) 5-25
 - SC (SET_CASE) 5-17
 - SO (SUBSTITUTE_ONCE) 5-28
 - special characters 3-5
 - specifying interactively 3-2
 - UNDO (Undo previous command(s)) 5-29
 - using 3-2ff
 - WA (WINDOW_AUTOHOLD) 4-25
 - WC (WINDOW_CLOSE) 4-16
 - WD (WINDOW_DEFAULT) 4-25f
 - WGE (WINDOW_GROW_ECHO) 4-18
 - WGRA (WINDOW_GROUP_ADD) 4-32
 - WGRR (WINDOW_GROUP_REMOVE) 4-32
 - WH (WINDOW_HOLD) 4-24
 - WI (WINDOW_INVISIBLE) 4-33
 - WME (WINDOW_MOVE_ECHO) 4-20
 - WP (WINDOW_POP) 4-21
 - WS (WINDOW_SCROLL) 4-24
 - XC (Copy text) 5-12
 - XD (Cut (delete) text) 5-14
 - XI (Copy portion of display) 5-13
 - XP (Paste text) 5-15
- DM
- defining window boundaries 4-11f
- DM scripts
- executing 3-2
- DM (see Display Manager)
- DM start-up script 2-18f
- defining default window positions 4-25f
- dollar sign (\$)
 - as Shell command prompt 6-2
 - in regular expressions 5-17
- DOMAIN ring network 1-2
- DOMAIN Server Processor (see DSP)
- DOMAIN System 1-1ff
 - at log-in 2-13ff
 - at start-up 2-2ff
- DQ (DEBUG_QUIT) command 4-9
- DR command 3-9, 4-15
- DS (DEBUG_SUSPEND) command 4-10
- DSP (DOMAIN Server Processor) 2-4, 2-11
- DSP
 - logging into 2-22
- ## E
- ED (Delete character at cursor) command 5-7
- ED (EDIT) command 9-9
- EDACL (EDIT_ACCESS_CONTROL_LIST) command 8-7, 8-9
 - adding access rights 8-16
 - adding ACL entries 8-15
 - changing access rights 8-15
 - deleting access rights 8-17
 - deleting ACL entries 8-17
 - editing commands 8-9
 - operation modes 8-9
- EDFONT (EDIT_FONT) program 3-21, 4-35
- EDIT key 3-21, 4-13, 7-6
- edit modes 5-3
- edit pads
 - deleting 4-16
 - modes 5-2
 - saving contents of 4-17
 - window legend 5-3
- editing
 - ACLs 8-9
 - files 4-13
 - initial ACLs 8-20
 - pads 5-1ff
- EE (Delete character before cursor) command 5-8
- EEF (Insert end-of-file) command 5-6
- EI (Set insert/overstrike mode) command 4-24, 5-4
- ellipsis (...),
 - as pathname wildcard character 6-20
- EN (Insert NEWLINE) command 5-6
- end-of-file mark
 - inserting into pads 5-6
- end-of-line character
 - matching 5-17
- enlarging windows 4-19
- ENSUBS (ENTER_SUBSYSTEM) command 8-27
- entering
 - protected subsystems 8-27
 - Shell commands 6-2

- entry directory 1-4f
 - beginning pathnames 1-8
- environment variables 9-22
- EOFF command 9-20
- EON command 9-20
- equal sign (=)
 - as comparison operator 9-17
 - as pathname wildcard character 6-21
- error input 6-10
 - in reading query responses 6-16
- error output 6-10, 6-12
 - appending to files 6-13
 - displaying query options 6-16
 - redirecting 6-12
- ES (Insert string) command 5-5
- escape character (@)
 - in DM commands 3-5
 - in Shell commands 6-4
- evaluating
 - expressions 9-12
 - Shell variables 9-20
- exclamation mark (!)
 - as substitution character 9-7
- executing
 - DM commands
 - from scripts 3-22f
 - from Shell scripts 9-10
 - Shell scripts 6-2
- EXISTVAR (EXIST_VARIABLE)
 - command 9-21
- EXIT command 9-30, 9-35
- EXIT key 4-17
- EXPORT command 9-21f
- expressions
 - delimiters 9-12
 - evaluating 9-12, 9-20
 - in Shell scripts 9-12ff
 - operands 9-14
 - regular 5-16
 - characters used in 5-17ff
- EXPUNGE access rights 8-7

F

- F1 key 5-6
- F6 key 5-8
- F7 key 5-8
- files
 - appending 7-10f
 - appending standard output to 6-12f
 - as standard input 6-11

- ASCII
 - comparing 7-19
- assigning protected subsystem status to 8-27
- backup 4-17, 5-30
 - access rights 8-14
- boot script 2-5, 2-11
- commands for managing 7-5
 - comparing 7-19
 - copying 7-8
 - copying display to 7-18f
 - creating 4-13, 7-5
 - deleting 7-18
 - displaying attributes 7-16f
- edit
 - updating 5-30
- editing 4-13
- in protected subsystems 8-22f
- initial ACLs 7-6
- keyboard definitions 3-12f
- managing 7-5ff
- moving 7-9
- names 6-17
- printing 7-11
 - in interactive mode 7-12
 - on other nodes 7-12
 - using print menu interface 7-13ff
- protecting 8-1ff
- reading pathnames from 6-17
- renaming 7-7
- replacing 7-9
- saving 4-17, 7-5
- saving transcript pads In 4-30
- Shell command 6-2
- startup
 - DM 2-18f
- start-up
 - Shell 6-8f
- operators 9-13
- valid access rights 8-12
- writing Shell command output to 6-12
- writing Shell error output to 6-12

- filters 6-13
- FMT (FORMAT_TEXT) command 6-12
- font editor (EDFONT) (See EDFONT)
- FOR command 9-31f
- FOR statement 9-31f
- formats
 - for DM commands 3-4
 - for Shell command lines 6-3
- function keys
 - predefined 3-10f
 - to invoke DM commands 3-3, 3-10ff

G

greater-than (>)
 as comparison operator 9-16
 redirecting standard output 6-12
greater-than/question mark (>?)
 redirecting error output 6-12
GROW key 4-19

H

here document 9-9
HOLD key 3-22
hold mode 4-23f
home directory 2-15
 changing at log-in 2-21
hyphen (-)
 preceding DM command options
 3-4
 preceding Shell command options
 6-3
 **reading data from standard input
 6-17**

I

ICON command 4-34
ICON_GROUP paste buffer 4-38
icons 4-31ff, 4-33ff
 changing into windows 4-35
 creating 4-35
 defaults 4-35
 group paste buffer 4-37
 **setting default position and offset
 4-36**
IDF (ICON_DEFAULT) command
4-36
IF command 9-28
IF statement 9-26, 9-28f
information
 sharing 1-3
initial ACLs 8-18f
 commands for editing and copying
 8-20
 copying 8-21
 editing 8-20
initial naming directory
 at log-in 2-15
initial working directory
 at log-in 2-15

INLIB (INITIALIZE_LIBRARY)
 command 6-5
 in-line data
 in Shell scripts 9-9f
INS key 5-4
INS MODE key 5-4
insert mode 4-23f, 5-4
inserting
 blank lines into pads 5-6
 characters into pads 5-4ff
 end-of-file mark into pads 5-6
 NEWLINE characters into pads 5-6

integers
 in expressions 9-14
interactive
 procedure for specifying DM
 commands 3-2
internal Shell commands 6-5
INVIS_GROUP paste buffer 4-38
invoking
 DM commands
 using control key sequences 3-3
 **using control key sequences
 3-10ff**
 using function keys 3-3
 using function keys 3-10ff
 Shells 6-7f
 subordinate Shells 6-8
I/O control characters 6-11

K

KD (KEY_DEFINITION) command
3-18
key definitions
 deleting 3-21
 displaying 3-21
 embedding key definitions in 3-19
keyboards
 880 3-12
 key names 3-16
 start-up definitions 3-14
low-profile
 key names 3-16
 Model I 3-12
 Model II 3-12
 start-up definitions 2-7, 3-14
types 3-12
keys
 ABORT 4-7, 4-16
 BACK SPACE 5-8
 CHAR DEL 5-7
 CMD 3-2

controlling from within a program

3-22

COPY 3-15

CTRL/A 4-25

CTRL/B 4-28

CTRL/E 5-14

CTRL/M 4-14, 5-3

CTRL/N 4-7, 4-16

CTRL/P 4-22

CTRL/Q 4-9

CTRL/R 5-25

CTRL/S 4-24

CTRL/T 4-28

CTRL/U 5-25

CTRL/X 4-19, 5-25

CTRL/Y 4-17, 5-30, 7-5

CTRL/Z 4-7, 5-6, 6-17

saving EDACL changes 8-10

CUT 3-15, 5-14

defining 3-18ff

at log-in 2-18

at start-up 2-7

at start-up 2-11

at start-up 3-12ff

from within a program 3-18

from within a program 3-22

to prompt for input 3-20

deleting definitions 3-21

displaying definitions 3-21

EDIT 3-21, 4-13, 7-6

embedded definitions 3-19

EXIT 4-17

F1 5-6

F6 5-8

F7 5-8

for scrolling pads 4-29

GROW 4-19

HOLD 3-22

INS 5-4

INS MODE 5-4

MARK 3-10, 4-15

MOVE 4-20

naming conventions 3-15ff

PASTE 5-15

POP 4-22

READ 3-20, 4-14

RETURN 3-2, 5-6

SAVE 5-30

SHELL 6-7

SHIFT 3-15

with pad scroll keys 4-29

shifted name 3-15

to perform DM functions 3-10ff

UNDO 5-29

up-transition name 3-15

L

LD (LIST DIRECTORY) command
displaying directory information 7-28

displaying file attributes 7-16f

displaying link resolution names 7-33

in Shell script 9-2

less-than (<)

redirecting standard Input 6-11

links

commands for managing 7-31

copying 7-35

creating 7-32

deleting 7-36

managing 7-31ff

redefining 7-33

renaming 7-34

replacing 7-35f

resolution names

displaying 7-33

loading

key definitions 2-7

operating system across network 2-10f

logging in

as USER 2-20

basic procedure 2-20

changing home directory 2-21

changing password 2-20

to a DSP 2-22

logical operators 9-17

log-in

executing DM commands 2-18

failure 2-15

gathering SID Information 8-2

sequence 2-14

log-in home directory 2-15

log-in start-up script 2-15

creating 2-17

creating Shell process 4-6

locations 2-16

LVAR (LIST_VARIABLES) command 9-21

M

mailbox server (see MBX_HELPER)

managing

ACLs 8-7f

directories 7-20ff

- files 7-5ff
- links 7-31ff
- windows 4-17ff
- MARK key 3-10, 4-15
- marking
 - a range of text in pads 5-9f
- mathematical operators 9-14f
- MBX_HELPER (mailbox server) 4-8
- merging
 - directory trees 7-26f
- messages
 - error
 - file not found 4-14
 - request to quit edit 4-17
 - searching for text 5-24
 - substitute in progress 5-26
- Mnemonic Debugger (MD) 2-3, 2-10
- Model I keyboard 3-12
- Model II keyboard 3-12
- modes
 - edit 5-3
 - for edit pads 5-2
 - for process windows 4-23
 - insert 5-4
 - overstrike 5-4
 - read-only 5-3
 - read/write 5-3
- mouse
 - default function keys 3-11
- MOVE key 4-20
- moving
 - around the naming tree 7-2
 - cursor 4-2f
 - files 7-9
 - pads under windows 4-27ff
 - to bottom of pad 4-27f
 - to first character in pad 4-28
 - to last character in pad 4-28
 - to top of pad 4-27f
 - windows 4-20
- MVF (MOVE FILE) command 7-9

N

- names file 6-17
- naming directory 1-11
 - at log-in 2-15
 - changing 7-4
 - displaying 7-3
 - setting 7-3
- Naming Server Helper (NS_HELPER) 1-6
- naming tree 1-4ff
 - moving around 7-2

- search for Shell commands 6-5ff
- ND (NAMING DIRECTORY)
 - command 7-3
- NETBOOT 2-10f
- NETMAN 2-7
 - creating 'NODE_DATA 2-12
 - during diskless start-up 2-10
- network partner
 - as boot volume 1-3
 - node 2-10
- network
 - ring 1-2
- network root directory 1-4f
 - in absolute pathnames 1-7
- NEWLINE character
 - deleting from pads 5-7
 - inserting into pads 5-6
- NEXT command 9-30, 9-35
- node entry directory 1-4f
 - beginning pathnames 1-8
- 'NODE_DATA
 - on disked nodes 2-4
 - on diskless nodes 2-11
- 'NODE DATA/PASTE_BUFFERS /DEFAULT.GMF 5-13
- 'NODE_DATA/STARTUP
 - creating processes from 4-7
- nodes
 - boot script files 2-5, 2-11
 - cataloging 1-5f
 - disked 1-3
 - disked start-up 2-2ff
 - diskless 1-3
 - diskless start-up 2-8ff
 - IDs 2-10
 - in DOMAIN system 1-1
 - partner 2-10
 - powering on 2-3, 2-10
- NS_HELPER 1-6

O

- N objects 1-1
 - organization 1-4
 - protecting 8-1ff
- offset
 - for icon positions 4-36
- ONEOF statement 9-35
- operands
 - in expressions 9-14
- operating system
 - booting 2-4
 - booting on diskless node 2-10
 - components 1-3

- loading across the network 2-10f
- operators
 - comparison 9-16f
 - in expressions 9-13
 - logical 9-17
 - mathematical 9-14f
 - parsing 6-22
 - precedence 9-13
 - string 9-15f
- options
 - command parser 6-15
 - in DM commands 3-4
 - in Shell commands 6-3
- overstrike mode 4-23f, 5-4

P

- PAD_\$DEF_PFK call 3-18, 3-22
- PAD_\$DM_CMD call 3-22
- pads
 - closing 4-16
 - copying 4-15
 - copying text 5-12
 - creating 4-10ff
 - defining a range of text in 5-9f
 - edit
 - inserting blank lines into 5-6
 - creating 4-13
 - cutting text from 5-14
 - deleting characters from 5-7f
 - deleting lines of text from 5-8
 - deleting NEWLINE characters from 5-7
 - deleting text from 5-7ff
 - deleting words from 5-8
 - inserting characters into 5-4ff
 - inserting end-of-file mark into 5-6
 - inserting NEWLINE characters into 5-6
 - inserting text string into 5-5
 - modes 5-2
 - opening 7-6
 - pasting text into 5-15
 - substituting text in 5-26ff
 - window legend 5-3
 - editing 5-1ff
 - moving to bottom of 4-28
 - moving to first character 4-28
 - moving to last character 4-28
 - moving to top of 4-27f
 - moving under windows 4-27ff
 - process input 6-10
 - process output 6-10

- read-only 4-14
- saving transcript in a file 4-30
- scrolling horizontally 4-30
- scrolling vertically by lines 4-29
- scrolling vertically by pages 4-28
- searching for text in 5-22ff
- Shell input 6-2
- specifying text patterns in 5-16
- parent directory 1-12f
- parentheses ()
 - as pathname wildcard characters 6-21
- parser options 6-15
- parsing operators 6-22, 9-3
- partner node 2-10
- passing
 - arguments to Shell scripts 9-4ff
- password
 - changing at log-in 2-20
 - entering at login 2-15
- paste buffers
 - copying text into 5-12, 5-14
 - creating 5-11
 - default
 - writing text to 5-7
 - deleting 5-11
 - for icon groups 4-37
 - for window groups 4-37
 - pasting contents into pads 5-15
- PASTE key 5-15
- pasting
 - text into pads 5-15
- pathnames
 - absolute 1-7, 7-6
 - beginning at naming directory 1-11
 - beginning at network root directory 1-7
 - beginning at node entry directory 1-8
 - beginning at parent directory 1-12f
 - beginning at working directory 1-9f
 - reading from files 6-17
 - reading from standard input 6-17
 - symbols 1-9
 - to identify objects 1-6ff
 - wildcards 6-18ff
- PB (PAD_BOTTOM) command 4-28
- percent sign (%)
 - as pathname wildcard character 6-18f
 - as SID wildcard 8-3, 8-11
 - regular expressions 5-17
- pipelines 6-13
- pipes 6-13
- PN (PAD_NAME) command 4-30
- point pair 4-10

- points
 - defining 3-2, 3-4, 3-6ff
 - preceding DM commands 3-4
- POP command 4-22
- pound sign character (#)
 - in DM commands 3-5
 - in Shell commands 9-2
- power on
 - to start up node 2-3, 2-10
- PP (PAD_PAGE) command 4-28
- predefined function keys 3-10f
- PRF (PRINT_FILE) command 6-17, 7-11
- PRFD (PRINT_FILE_DIALOG) command 7-13
- print menu interface 7-13ff
- print server (PRSVR) 2-7
- printing
 - display images 5-14, 7-18f
 - files 7-11
 - in interactive mode 7-12
 - on other nodes 7-12
 - using print menu interface 7-13ff
- PRINT_SERVER (see PRSVR) 7-11
- process window legend 4-23
- processes
 - background 6-22
 - closing pads 4-7
 - closing windows 4-7
 - creating 4-4
 - at log-in 2-17
 - with pads and windows 4-5f
 - without pads and windows 4-7
 - interrupting execution of 4-10
 - nammg directory
 - changing 7-4
 - displaying 7-3
 - passing data 6-9
 - resuming 4-10
 - running the Shell 4-6
 - servers 4-4
 - Shell 6-2
 - creating 6-7f
 - SID 8-3, 8-11
 - standard streams 6-9f
 - stopping 4-8f
 - with CTRL/Z 5-6
 - suspending 4-10
 - transcript pads 6-10
 - window legend 4-23
 - window modes 4-23
 - working directory
 - changing 7-3
 - displaying 7-3
- program
 - input and output 6-10
 - Programmable Read-Only Memory (see PROM)
 - programs
 - as protected subsystem managers 8-22f
 - EDFONT 4-35
 - running in background processes 6-22
 - server 4-4
 - Shell
 - creating 6-8
 - PROM (Programmable Read-Only Memory) 2-4, 2-10
 - prompt
 - for changing home directory 2-21
 - prompts
 - for DM commands 3-2
 - Edit file: 4-13
 - for continuing Shell commands 6-4f
 - for EDACL 8-9
 - for Shell commands 6-2
 - for variable assignment input 9-24
 - in key definitions 3-20
 - protected subsystems 8-22f
 - assigning status to files 8-27
 - creating 8-26
 - entering 8-27
 - protecting
 - files and directories 8-1ff
 - PRSVR (PRINT_SERVER) 7-11
 - PRSVR (see print server) 2-7
 - PT (PAD_TOP) command 4-28
 - pushing and popping windows 4-21
 - PV (PAD_LINE) command 4-29
 - PW (PAD_WRITE) command 5-30

Q

- query options 6-16
- question mark (?)
 - as path name wildcard character 6-18f
- question mark
 - in regular expressions 5-18
- queues
 - print 7-11f
- quoted stings 9-8

R

- READ command 9-23
- READ key 3-20, 4-14

- READC command 9-24
 - reading
 - data from standard input 6-16f
 - pathnames from files 6-17
 - pathnames from standard input 6-17
 - standard input from files 6-11f
 - READLN command 9-24
 - read-only mode 5-3
 - read-only pads 4-14
 - deleting 4-16
 - read-only windows 4-14
 - read/write mode 5-3
 - redefining
 - links 7-33
 - redirecting
 - error output 6-12
 - output to Shell commands 6-13
 - standard input 6-11, 9-9
 - standard output 6-12
 - reducing strings 9-16
 - regions
 - defining 3-2f, 3-6ff
 - preceding DM commands 3-4
 - regular expressions 5-16
 - characters used in 5-17ff
 - removing
 - entries from window groups 4-32f
 - renaming
 - directories 7-21f
 - files 7-7
 - links 7-34
 - repeating
 - search operation 5-25
 - replacing
 - all occurrences of a string 5-27
 - directory trees 7-25f
 - files 7-9
 - first occurrence of a string 5-28
 - links 7-35f
 - text in pads 5-26ff
 - responding
 - to DM alarms 4-26
 - resuming
 - processes 4-10
 - RETURN key 3-2, 5-6
 - RO (READ_ONLY) command 5-3
 - RO (Set read/write mode) command 4-14
 - root directory 1-4f
 - in absolute pathnames 1-7
 - rubberband 4-19
 - rules
 - for assigning variables 9-19
 - for Shell command search 6-2
 - for specifying ACL entries 8-11f
 - running
 - programs in background processes 6-2
- ## S
- S (SUBSTITUTE) command 5-27
 - SAVE key 5-30
 - saving
 - contents of an edit-pad 4-17
 - EDACL changes 8-10
 - files 7-5
 - Shell command output 6-10
 - transcript pads 4-30
 - SC (Set case comparison) 5-25
 - SC (SET_CASE) command 5-17
 - screen coordinates 3-8
 - scripts
 - boot 2-4, 2-11
 - DM
 - command 3-22f
 - executing 3-2
 - including comments 3-5
 - start-up 2-18f
 - start-up 3-22
 - executing at login 2-13ff
 - log-in start-up 2-15, 4-6
 - Shell (see Shell scripts)
 - start-up 6-8f
 - scroll mode 4-23f
 - scrolling
 - keys 4-29
 - pads horizontally 4-30
 - pads vertically by lines 4-29
 - pads vertically by pages 4-28
 - SEARCH access rights 8-7
 - searching
 - cancelling operation 5-25
 - entire pad 5-24
 - for Shell commands 6-5
 - for text in pads 5-22ff
 - repeating operation 5-25
 - securing accounts 2-21
 - SELECT command 9-34f
 - SELECT statement 9-34f
 - semicolon (;)
 - separating command lines 6-4
 - separating DM commands 3-5
 - Server Process Manager (see SPM)
 - server processes
 - creating 4-8
 - server programs 4-4
 - servers
 - alarm 4-7

- MBX HELPER 4-8
- naming 1-6
- NETMAN 2-7, 2-12
- process manager 2-4, 2-11
- PRSVR 2-7
- PRSVR (PRINT_SERVER) 7-11
- starting from boot script 2-7
- setting
 - case comparison 5-25
 - default icon position and offset 4-36
 - initial Shell environment 6-8
 - naming directory 7-3
 - read/write modes 5-3, 5-3
 - working directory 7-3
- SH (SHELL) command 6-8, 9-11
- 9-20
- SH (SHELL) command 6-7
- Shell 1-3, 6-1ff
 - ACL (ACCESS_CONTROL_LIST) 8-7
 - copying ACLs 8-18
 - copying initial ACLs 8-21f
 - displaying ACLs 8-8
 - ARGS (ARGUMENTS) 9-4
 - as filters 6-13
 - BOFF 6-22
 - BON 6-22
 - CATF (CATENATE_FILE) 6-12
 - CATF (CATENATE_FILES) 7-10f
 - character limit 6-4
 - CHN (CHANGE_NAME) 7-7, 7-21, 7-34
 - CMF (COMPARE_FILE) 7-19
 - CMT (COMPARE_TREE) 7-27
 - continuing on next line 6-4
 - controlling input and output 6-9f
 - controlling queries 6-15
 - CPF (COPY_FILE) 7-8
 - CPL (COPY_LINK) 7-35, 7-35f
 - CPSCR (COPY_SCREEN) 7-18
 - CPT (COPY_TREE) 7-23, 7-25, 7-26
 - CRD (CREATE_DIRECTORY) 7-21
 - CRL (CREATE_LINK) 7-32, 7-33
 - CRSUBS (CREATE_SUBSYSTEM) 8-26
 - CSR (COMMAND_SEARCH_RULES) 6-6
 - DATE 6-2, 9-24
 - DLDUPL (DELETE_DUPLICATE_LINES) 6-13f
 - DLF (DELETE_FILE) 7-18
 - DLL (DELETE_LINK) 7-36
 - DLT (DELETE_TREE) 7-30
 - DLVAR (DELETE_VAR) 9-21f
 - ED (EDIT) 9-9
 - (EDIT_ACCESS_CONTROL_LIST) 8-7, 8-9
 - ENSUBS (ENTER_SUBSYSTEM) 8-27
 - entering 6-2
 - EOFF 9-20
 - insert/overstrike modes 5-4
 - EON 9-20
 - EXISTVAR (EXIST_VARIABLE) 9-21
 - EXIT 9-30, 9-35
 - EXPORT 9-21f
 - FMT (FORMAT_TEXT) 6-12
 - FOR 9-31f
 - format 6-3
 - Shell commands 6-2ff
 - IF 9-28
 - in active functions 9-24f
 - in Shell scripts 9-1ff
 - INLIB (INITIALIZE_LIBRARY) 6-5
 - internal 6-5
 - LD (LIST_DIRECTORY) 7-16f, 7-28, 7-33
 - LVAR (LIST_VARIABLES) 9-21
 - MVF (MOVE_FILE) 7-9
 - ND (NAMING_DIRECTORY) 7-3
 - NEXT 9-30, 9-35
 - PRF (PRINT_FILE) 6-17, 7-11
 - PRFD (PRINT_FILE_DIALOG) 7-13
 - processing command line information 6-14ff
 - READ 9-23
 - READC 9-24
 - reading input from files 6-11f
 - READLN 9-24
 - saving output 6-10
 - search rules 6-2
 - SELECT 9-34f
 - SH (SHELL) 6-7, 6-8, 9-11, 9-20
 - SRF (SORT_FILE) 6-13f
 - standard options 6-4f
 - SUBS (SUBSYSTEM) 8-27
 - TLC (TRANSLITERATE_CHARACTER) 6-12
 - VOFF 9-11
 - VON 9-11
 - WD (WORKING_DIRECTORY) 7-3
 - WHILE 9-30
 - writing error output to files 6-12

- writing output to files 6-12
- XOFF 9-11
- XDMC
 - (EXECUTE_DM_COMMAND) 9-10
- XON 9-11
- Shell
 - creating 6-7f
 - creating process 4-6
 - input pad 6-2
 - invoking 6-7f
- SHELL key 6-7
- Shell
 - parsing operators 9-3
- Shell process
 - creation at log-in 2-17
- Shell scripts 9-1ff
 - controlling execution 9-25ff
 - creating 9-2f
 - debugging 9-10f
 - defining variables interactively 9-22f
 - executing DM commands 9-10
 - passing arguments to 9-4ff
 - quoted strings 9-8
 - using active functions 9-24f
 - using conditional statements 9-26ff
 - using expressions 9-12ff
 - using variables 9-18ff
- Shell
 - setting up initial environment 6-8
 - start-up files 6-8
 - subordinate
 - creating 6-8
- Shell variables 9-18ff
 - assigning active functions 9-24
 - assignment rules 9-19
 - defining 9-18
 - defining interactively 9-22f
 - environment 9-22
 - evaluating 9-20
 - substituting 9-19f
- SHIFT key 3-15
 - with pad scroll keys 4-29
- shifted key name 3-15
- shrinking windows 4-19
- SID (subject identifier) 4-4
 - for processes created at start-up 4-7
 - in ACL entries 8-2f
- single quotes (' ')
 - in DM commands 3-5
- site registry directory 2-21
- slash (/)
 - to search forward for text 5-23
- SO (SUBSTITUTE_ONCE) command 5-28
- special characters
 - in DM commands 3-5
 - in Shell commands 6-7
- specifying
 - ACL entries 8-11f
 - DM commands 3-2f
 - Shell commands 6-2
 - text patterns in pads 5-16
- SPM (Server Process Manager) 2-4, 2-11
- square brackets ([])
 - as pathname wildcard character 6-19
 - in regular expressions 5-19
- SRF (SORT_FILE) command 6-13f
- standard input 6-10
 - connecting to standard output 6-13
 - reading data from 6-16f
 - reading pathnames from 6-17
 - redirecting 6-11
 - redirecting to read in-line data 9-9
- standard options
 - for Shell commands 6-4f
- standard output 6-10
 - appending to files 6-12f
 - connecting to standard input 6-13
 - in active functions 9-24f
 - redirecting 6-12
- standard streams 6-9f
- start-up
 - boot scripts 2-5, 2-11
 - defining keys 2-7
 - differences between disked and diskless nodes 2-12
 - disked nodes 2-2ff
 - diskless nodes 2-8ff
 - files
 - Shell 6-8f
 - sequence for disked nodes 2-3, 2-9ff
- STARTUP_LOGIN 2-17
- statements
 - CASE 9-34
 - FOR 9-31f
 - IF 9-26, 9-28f
 - ONEOF 9-35

- SELECT 9-34f T
- WHILE 9-29
- stopping
 - processes 4-8f
- streams 6-9f
 - closing with CTRL/Z 5-6
- string operators 9-15f
- strings
 - changing case of 5-28
 - concatenating 9-15
 - deleting from pads 5-8
 - in expressions 9-14
 - inserting into pads 5-5
 - quoted 9-8
 - reducing 9-16
 - searching for 5-22ff
 - substituting all occurrences of 5-28
 - substituting first occurrence of 5-28
 - substituting in pads 5-26
- structure
 - of ACLs 8-2
- subject identifier (SID) (See SID)
- subordinate Shell 6-7
 - creating 6-8
- SUBS (SUBSYSTEM) command 8-27
- substituting
 - all occurrences of a string 5-27
 - first occurrence of a string 5-28
 - for variables 9-19f
 - text in pads 5-26ff
- substitution parameters 9-5
- suspending
 - processes 4-10
- symbols
 - for pathnames 1-9
- /SYS
 - as upper-level directory 1-5
- SYSBOOT 2-4
 - in diskless start-up 2-10
- /SYS/DM/FONTS/ICONS 4-35
- /SYS/DM/STARTUP_LOGIN 4-6
- /SYS/DM/STD_KEYS 3-14
- /SYS/NET/DISKLESS_LIST 2-10
- /SYS/NET/NETBOOT 2-10f
- /SYS/NODE_DATA 2-4
- /SYS/NODE_DATA/node_id 2-4, 2-11
- /SYS/PRINT/QUEUE 7-11f
- system calls
 - PAD_\$DEF_PFK 3-18, 3-22
 - PAD_\$DM_CMD 3-22

T

- text
 - changing case of 5-28
 - copying from pads 5-12
 - cutting from pads 5-14
 - defining a range of 5-9f
 - deleting from pads 5-7ff
 - lines
 - deleting from pads 5-8
 - past into pads 5-15
 - searching for 5-22ff
 - specifying patterns in pads 5-16
 - substituting in pads 5-25ff
- tilde (~)
 - as pathname wildcard character 6-20
 - beginning pathnames 1-11
 - in regular expressions 5-19
- TLC (TRANSLITERATE_CHARACTER)
 - command 6-12
- transcript pad
 - saving in file 4-30
- transcript pads 6-10

U

- undo buffers 5-29
- UNDO key 5-29
- UNDO (Undo previous command(s))
 - command 5-29
- undoing
 - previous command 5-29
- updating
 - edit files 5-30
- upper-level directory 1-4
- up-transition
 - key name 3-15
- USER_DATA/KEY_DEFS 2-19
- /USER_DATA/KEY_DEFS 3-18
- USER_DATA/KEY_DEFS2 2-19
- ~USER_DATA/SH 6-8
- /USER_DATA/STARTUP_DM 2-18f
- username
 - entering at log-in 2-15
 - in SID 4-4, 8-2

V

- variables
 - in Shell (see Shell variables)
- verifying
 - Shell scripts 9-11
- viewing
 - hidden windows 4-21
- VOFF command 9-11
- VON command 9-11

W

- WA (WINDOW_AUTOHOLD) command 4-25
- WC (WINDOW_CLOSE) command 4-16
- WD (WINDOW_DEFAULT) command 4-25
- WD (WORKING_DIRECTORY) command 7-3
- WGE (WINDOW_GROW_ECHO) command 4-18
- WGRA (WINDOW_GROUP_ADD) command 4-32
- WGRR (WINDOW_GROUP_REMOVE) command 4-32
- WH (WINDOW_HOLD) command 4-24
- WHILE command 9-29
- WHILE statement 9-29
- WI (WINDOW_INVISIBLE) command 4-33
- wildcards 6-18ff
 - query verification 6-16
 - verification 6-10
- window groups 4-31ff
 - changing into icons 4-34
 - creating 4-31f
 - displaying members 4-37
 - making invisible 4-33
 - making visible 4-33
 - paste buffers 4-37
 - removing entries from 4-32f
- window icons 4-31ff
- windows
 - alarm 4-26
 - cancelling move 4-20
 - cancelling size change 4-19
 - changing groups into icons 4-34
 - changing size of 4-18f
 - closing 4-16
 - copying 4-15
 - creating 4-10ff

- defining default positions 4-25
- deleting 5-7
- determining boundaries 4-11f
- displaying members of window groups 4-37
- drawing at start-up 2-7
- edit
 - creating 4-13
- edit pad window legend 5-3
- group paste buffers 4-37
- in groups 4-31ff
- legend 4-23
- making invisible 4-33
- making visible 4-33
- managing 4-17ff
- moving 4-20
- moving pads under 4-27ff
- process
 - changing modes 4-22ff
 - pushing and popping 4-21
- read-only 4-14
- removing from window groups 4-32f
- representing with icons 4-33ff
- using icons 4-31ff

- WME (WINDOW_MOVE_ECHO) command 4-20
- words
 - deleting from pads 5-8
 - inserting into pads 5-5
- working directory 1-9f, 7-2
 - at log-in 2-15
 - beginning pathnames 1-9f
 - changing 7-3
 - setting 7-3
- WP (WINDOW_POP) command 4-21
- writing
 - error output to files 6-12
 - standard output to files 6-12
- WS (WINDOW_SCROLL) command 4-24

X

- XC (Copy text) command 5-12
- XD (Cut (delete) text) command 5-14
- XDMC (EXECUTE_DM_COMMAND) command 9-10
- XI (Copy portion of display) command 5-13
- XOFF command 9-11
- XON command 9-11
- XP (Paste text) command 5-15